

黃金海灣·意嵐  
GOLD COAST BAY  
THE UPPLAND

SALES BROCHURE 售樓說明書



You are advised to take the following steps before purchasing first-hand residential properties.

For all first-hand residential properties

### 1. Important information

- Make reference to the materials available on the Sales of First-hand Residential Properties Electronic Platform (SRPE) ([www.srpe.gov.hk](http://www.srpe.gov.hk)) on the first-hand residential property market.
- Study the information on the website designated by the vendor for the development, including the sales brochure, price lists, documents containing the sales arrangements, and the register of transactions of a development.
- Sales brochure for a development will be made available to the general public at least 7 days immediately before a date of sale while price list and sales arrangements will be made available at least 3 days immediately before the date of sale.
- Information on transactions can be found on the register of transactions on the website designated by the vendor for the development and the SRPE.

### 2. Fees, mortgage loan and property price

- Calculate the total expenses of the purchase, such as solicitors' fees, mortgage charges, insurance fees and stamp duties.
- Check with banks to find out if you will be able to obtain the needed mortgage loan, select the appropriate payment method and calculate the amount of the mortgage loan to ensure it is within your repayment ability.
- Check recent transaction prices of comparable properties for comparison.
- Check with the vendor or the estate agent the estimated management fee, the amount of management fee payable in advance (if any), special fund payable (if any), the amount of reimbursement of the deposits for water, electricity and gas (if any), and/or the amount of debris removal fee (if any) you have to pay to the vendor or the manager of the development.

### 3. Price list, payment terms and other financial incentives

- Vendors may not offer to sell all the residential properties that are covered in a price list. To know which residential properties the vendors may offer to sell, pay attention to the sales arrangements which will be announced by the vendors at least 3 days before the relevant residential properties are offered to be sold.
- Pay attention to the terms of payment as set out in a price list. If there are discounts on the price, gift, or any financial advantage or benefit to be made available in connection with the purchase of the residential properties, such information will also be set out in the price list.

- If you intend to opt for any mortgage loan plans offered by financial institutions specified by the vendor, before entering into a preliminary agreement for sale and purchase (PASP), you must study the details of various mortgage loan plans<sup>1</sup> as set out in the price list concerned. If you have any questions about these mortgage loan plans, you should check with the financial institutions concerned direct before entering into a PASP.

### 4. Property area and its surroundings

- Pay attention to the area information in the sales brochure and price list, and price per square foot/metre in the price list. According to the Residential Properties (First-hand Sales) Ordinance (Cap. 621) (the Ordinance), vendors can only present the area and price per square foot and per square metre of a residential property using saleable area. Saleable area, in relation to a residential property, means the floor area of the residential property, and includes the floor area of every one of the following to the extent that it forms part of the residential property - (i) a balcony; (ii) a utility platform; and (iii) a verandah. The saleable area excludes the area of the following which forms part of the residential property - air-conditioning plant room; bay window; cockloft; flat roof; garden; parking space; roof; stairhood; terrace and yard.
- Floor plans of all residential properties in the development have to be shown in the sales brochure. In a sales brochure, floor plans of residential properties in the development must state the external and internal dimensions of each residential property<sup>2</sup>. The external and internal dimensions of residential properties as provided in the sales brochure exclude plaster and finishes. You are advised to note this if you want to buy furniture before handing over of the residential property.
- Visit the development site and get to know the surroundings of the property (including transportation and community facilities). Check town planning proposals and decisions which may affect the property. Take a look at the location plan, aerial photograph, outline zoning plan and cross-section plan that are provided in the sales brochure.

### 5. Sales brochure

- Ensure that the sales brochure obtained is the latest version. According to the Ordinance, the sales brochure made available to the public should be printed or examined, or examined and revised within the previous 3 months.
- In respect of an uncompleted development, the vendor may alter the building plans (if any) whenever the vendor considers necessary. To know the latest information of an uncompleted development, keep paying attention to any revised sales brochures made available by the vendor.
- Read through the sales brochure and in particular, check the following information in the sales brochure –

- whether there is a section on “relevant information” in the sales brochure, under which information on any matter that is known to the vendor but is not known to the general public, and is likely to materially affect the enjoyment of a residential property will be set out. Please note that information contained in a document that has been registered with the Land Registry will not be regarded as “relevant information”;
- the cross-section plan showing a cross-section of the building in relation to every street adjacent to the building, and the level of every such street in relation to a known datum and to the level of the lowest residential floor of the building. This will help you visualize the difference in height between the lowest residential floor of a building and the street level, regardless of how that lowest residential floor is named;
- interior and exterior fittings and finishes and appliances;
- the basis on which management fees are shared;
- whether individual owners have obligations or need to share the expenses for managing, operating and maintaining the public open space or public facilities inside or outside the development, and the location of the public open space or public facilities; and
- whether individual owners have responsibility to maintain slopes.

### 6. Government land grant and deed of mutual covenant (DMC)

- Read the Government land grant and the DMC (or the draft DMC). Information such as ownership of the rooftop and external walls can be found in the DMC. The vendor will provide copies of the Government land grant and the DMC (or the draft DMC) at the place where the sale is to take place for free inspection by prospective purchasers.
- Check the Government land grant on whether individual owners are liable to pay Government rent.
- Check the DMC on whether animals can be kept in the residential property.

### 7. Information on Availability of Residential Properties for Selection at Sales Office

- Check with the vendor which residential properties are available for selection. If a “consumption table” is displayed by the vendor at the sales office, you may check from the table information on the progress of sale on a date of sale, including which residential properties are offered for sale at the beginning of that date of sale and which of them have been selected and sold during that date of sale.
- Do not believe in rumours about the sales condition of the development and enter into a PASP rashly.

**8. Register of Transactions**

- Pay attention to the register of transactions for a development. A vendor must, within 24 hours after entering into a PASP with a purchaser, enter transaction information of the PASP in the register of transactions. The vendor must, within 1 working day after entering into an agreement for sale and purchase (ASP), enter transaction information of the ASP in the register of transactions. Check the register of transactions for the concerned development to learn more about the sales condition of the development.
- Never take the number of registrations of intent or cashier orders a vendor has received for the purpose of registration as an indicator of the sales volume of a development. The register of transactions for a development is the most reliable source of information from which members of the public can grasp the daily sales condition of the development.

**9. Agreement for sale and purchase**

- Ensure that the PASP and ASP include the mandatory provisions as required by the Ordinance.
- Pay attention that fittings, finishes and appliances to be included in the sale and purchase of the property are inserted in the PASP and ASP.
- Pay attention to the area plan annexed to the ASP which shows the total area which the vendor is selling to you. The total area which the vendor is selling to you is normally greater than the saleable area of the property.
- Pay attention to the vendor's right to alter the building plans (if any) for an uncompleted development. The mandatory provisions to be incorporated in an ASP for uncompleted development as required by the Ordinance include a provision requiring the vendor to notify the purchaser in writing of such alteration if the same affects in any way the property within 14 days after its having been approved by the Building Authority.
- A preliminary deposit of **5%** of the purchase price is payable by you to the owner (i.e. the seller) on entering into a PASP.
- If you do not execute the ASP within **5 working days** (working day means a day that is not a general holiday or a Saturday or a black rainstorm warning day or gale warning day) after entering into the PASP, the PASP is terminated, the preliminary deposit (i.e. 5 % of the purchase price) is forfeited, and the owner (i.e. the seller) does not have any further claim against you for not executing the ASP.
- If you execute the ASP within 5 working days after the signing of the PASP, the owner (i.e. the seller) must execute the ASP within 8 working days after entering into the PASP.
- The deposit should be made payable to the solicitors' firm responsible for stakeholding purchasers' payments for the property.

**10. Expression of intent of purchasing a residential property**

- Note that vendors (including their authorized representative(s)) should not seek or accept any specific or general expression of intent of purchasing any residential property before the relevant price lists for such properties are made available to the public. You therefore should not make such an offer to the vendors or their authorized representative(s).
- Note that vendors (including their authorized representative(s)) should not seek or accept any specific expression of intent of purchasing a particular residential property before the sale of the property has commenced. You therefore should not make such an offer to the vendors or their authorized representative(s).

**11. Appointment of estate agent**

- Note that if the vendor has appointed one or more than one estate agents to act in the sale of any specified residential property in the development, the price list for the development must set out the name of all the estate agents so appointed as at the date of printing of the price list.
- You may appoint any estate agent (not necessarily from those estate agency companies appointed by the vendor) to act in the purchase of any specified residential property in the development, and may also not appoint any estate agent to act on your behalf.
- Before you appoint an estate agent to look for a property, you should -
  - find out whether the agent will act on your behalf only. If the agent also acts for the vendor, he/she may not be able to protect your best interests in the event of a conflict of interest;
  - find out whether any commission is payable by you to the estate agent and, if so, its amount and the time of payment; and
  - note that only licensed estate agents or salespersons may accept your appointment. If in doubt, you should request the estate agent or salesperson to produce his/her Estate Agent Card, or check the Licence List on the Estate Agents Authority website: [www.eaa.org.hk](http://www.eaa.org.hk).

**12. Appointment of solicitor**

- Consider appointing your own solicitor to protect your interests. If the solicitor also acts for the vendor, he/she may not be able to protect your best interests in the event of a conflict of interest.
- Compare the charges of different solicitors.

For first-hand uncompleted residential properties

**13. Pre-sale Consent**

- For uncompleted residential property under the Lands Department Consent Scheme, seek confirmation from the vendor whether the "Pre-sale Consent" has been issued by the Lands Department for the development.

**14. Show flats**

- While the vendor is not required to make any show flat available for viewing by prospective purchasers or the general public, if the vendor wishes to make available show flats of a specified residential property, the vendor must first of all make available an unmodified show flat of that residential property and that, having made available such unmodified show flat, the vendor may then make available a modified show flat of that residential property. In this connection, the vendor is allowed to make available more than one modified show flat of that residential property.
- If you visit the show flats, you should always look at the unmodified show flats for comparison with the modified show flats. That said, the Ordinance does not restrict the discretion of the vendor in arranging the sequence of the viewing of unmodified and modified show flats.
- Sales brochure of the development should have been made available to the public when the show flat is made available for viewing. You are advised to get a copy of the sales brochure and make reference to it when viewing the show flats.
- You may take measurements in modified and unmodified show flats, and take photographs or make video recordings of unmodified show flats, subject to reasonable restriction(s) which may be set by the vendor for ensuring safety of the persons viewing the show flat.

For first-hand uncompleted residential properties and completed residential properties pending compliance

**15. Estimated material date and handing over date**

- Check the estimated material date<sup>3</sup> for the development in the sales brochure.
  - The estimated material date for a development in the sales brochure is not the same as the date on which a residential property is handed over to purchaser. The latter is normally later than the former. However, the handing over date may be earlier than the estimated material date set out in the sales brochure in case of earlier completion of the development.
- Handing over date
  - The mandatory provisions to be incorporated in an ASP as required by the Ordinance include a provision requiring the vendor to apply in writing for an Occupation Document / a Certificate of Compliance or the Director of Lands' Consent to Assign (as the case may be) in respect of the development within 14 days after the estimated material date as stipulated in the ASP.

- For development subject to the Lands Department Consent Scheme, the vendor is required to notify the purchaser in writing that the vendor is in a position validly to assign the property within one month after the issue of the Certificate of Compliance or the Consent to Assign, whichever first happens; or
- For development not subject to the Lands Department Consent Scheme, the vendor is required to notify the purchaser in writing that the vendor is in a position validly to assign the property within 6 months after the issue of the Occupation Document including Occupation Permit.
- The mandatory provisions to be incorporated in an ASP as required by the Ordinance include a provision requiring completion of the sale and purchase within 14 days after the date of the notification aforesaid. Upon completion, the vendor shall arrange handover of the property to the purchaser.
- Authorized Person (AP) may grant extension(s) of time for completion of the development beyond the estimated material date.
  - The mandatory provisions to be incorporated in an ASP as required by the Ordinance include a provision that the AP of a development may grant an extension of time for completion of the development beyond the estimated material date having regard to delays caused exclusively by any one or more of the following reasons:
    - strike or lock-out of workmen;
    - riots or civil commotion;
    - force majeure or Act of God;
    - fire or other accident beyond the vendor's control;
    - war; or
    - inclement weather.
  - The AP may grant more than once such an extension of time depending on the circumstances. That means handover of the property may be delayed.
  - The mandatory provisions to be incorporated in an ASP as required by the Ordinance also include a provision requiring the vendor to, within 14 days after the issue of an extension of time granted by the AP, furnish the purchaser with a copy of the relevant certificate of extension.
- Ask the vendor if there are any questions on handing over date.

#### For first-hand completed residential properties

#### **16. Vendor's information form**

- Ensure that you obtain the "vendor's information form(s)" printed within the previous 3 months in relation to the residential property/properties you intend to purchase.

#### **17. Viewing of property**

- Ensure that, before you purchase a residential property, you are arranged to view the residential property that you would like to purchase or, if it is not reasonably practicable to view the property in question, a comparable property in the development, unless you agree in writing that the vendor is not required to arrange such a comparable property for viewing for you. You are advised to think carefully before signing any waiver.
- You may take measurements, take photographs or make video recordings of the property, unless the property is held under a tenancy or reasonable restriction(s) is/are needed to ensure safety of the persons viewing the property.

For complaints and enquiries relating to the sales of first-hand residential properties by the vendors which the Ordinance applies, please contact the Sales of First-hand Residential Properties Authority -

Website : [www.srpa.gov.hk](http://www.srpa.gov.hk)  
 Telephone : 2817 3313  
 Email : [enquiry\\_srpa@hd.gov.hk](mailto:enquiry_srpa@hd.gov.hk)  
 Fax : 2219 2220

#### **Other useful contacts:**

**Consumer Council**  
 Website : [www.consumer.org.hk](http://www.consumer.org.hk)  
 Telephone : 2929 2222  
 Email : [cc@consumer.org.hk](mailto:cc@consumer.org.hk)  
 Fax : 2856 3611

**Estate Agents Authority**  
 Website : [www.eaa.org.hk](http://www.eaa.org.hk)  
 Telephone : 2111 2777  
 Email : [enquiry@eaa.org.hk](mailto:enquiry@eaa.org.hk)  
 Fax : 2598 9596

**Real Estate Developers Association of Hong Kong**  
 Telephone : 2826 0111  
 Fax : 2845 2521

Sales of First-hand Residential Properties Authority  
 March 2023

#### Notes:

1. The details of various mortgage loan plans include the requirements for mortgagors on minimum income level, the loan limit under the first mortgage and second mortgage, the maximum loan repayment period, the change of mortgage interest rate throughout the entire repayment period, and the payment of administrative fees.
2. According to section 10(2)(d) in Part 1 of Schedule 1 to the Ordinance, each of the floor plans of the residential properties in the development in the sales brochure must state the following—
  - (i) the external dimensions of each residential property;
  - (ii) the internal dimensions of each residential property;
  - (iii) the thickness of the internal partitions of each residential property;
  - (iv) the external dimensions of individual compartments in each residential property.

According to section 10(3) in Part 1 of Schedule 1 to the Ordinance, if any information required by section 10(2)(d) in Part 1 of Schedule 1 to the Ordinance is provided in the approved building plans for the development, a floor plan must state the information as so provided.
3. Generally speaking, "material date" means the date on which the conditions of the land grant are complied with in respect of the development, or the date on which the development is completed in all respects in compliance with the approved building plans or the conditions subject to which the certificate of exemption is issued. For details, please refer to section 2 of the Ordinance.

您在購置一手住宅物業之前，應留意下列事項：

適用於所有一手住宅物業

### 1. 重要資訊

- 瀏覽一手住宅物業銷售資訊網(下稱「銷售資訊網」)(網址：[www.srpe.gov.hk](http://www.srpe.gov.hk))，參考「銷售資訊網」內有關一手住宅物業的市場資料。
- 閱覽賣方就該發展項目所指定的互聯網網站內的有關資訊，包括售樓說明書、價單、載有銷售安排的文件，及成交紀錄冊。
- 發展項目的售樓說明書，會在該項目的出售日期前最少七日向公眾發布，而有關價單和銷售安排，亦會在該項目的出售日期前最少三日公布。
- 在賣方就有關發展項目所指定的互聯網網站，以及「銷售資訊網」內，均載有有關物業成交資料的成交紀錄冊，以供查閱。

### 2. 費用、按揭貸款和樓價

- 計算置業總開支，包括律師費、按揭費用、保險費，以及印花稅。
- 向銀行查詢可否取得所需的按揭貸款，然後選擇合適的還款方式，並小心計算按揭貸款金額，以確保貸款額沒有超出本身的負擔能力。
- 查閱同類物業最近的成交價格，以作比較。
- 向賣方或地產代理瞭解，您須付予賣方或該發展項目的管理人的預計的管理費、管理費上期金額(如有)、特別基金金額(如有)、補還的水、電力及氣體按金(如有)，以及/或清理廢料的費用(如有)。

### 3. 價單、支付條款，以及其他財務優惠

- 賣方未必會把價單所涵蓋的住宅物業悉數推售，因此應留意有關的銷售安排，以了解賣方會推售的住宅物業為何。賣方會在有關住宅物業推售日期前最少三日公布銷售安排。
- 留意價單所載列的支付條款。倘買家可就購置有關住宅物業而連帶獲得價格折扣、贈品，或任何財務優惠或利益，上述資訊亦會在價單內列明。
- 如您擬選用由賣方指定的財務機構提供的各類按揭貸款計劃，在簽訂臨時買賣合約前，應先細閱有關價單內列出的按揭貸款計劃資料<sup>1</sup>。如就該些按揭貸款計劃的詳情有任何疑問，應在簽訂臨時買賣合約前，直接向有關財務機構查詢。

### 4. 物業的面積及四周環境

- 留意載於售樓說明書和價單內的物業面積資料，以及載於價單內的每平方呎/每平方米售價。根據《一手住宅物業銷售條例》(第621章)(下稱「條例」)，賣方只可以實用面積表達住宅物業的面積和每平方呎及平方米的售價。就住宅物業而言，實用面積指該住宅物業的樓面面積，包括在構成該物業的一部分的範圍內的以下每一項目的樓面面積：(i) 露台；(ii) 工作平台；以及(iii) 陽台。實用面積並不包括空調機房、窗台、閣樓、平台、花園、停車位、天台、梯屋、前庭及庭院的每一項目的面積，即使該些項目構成該物業的一部分的範圍。
- 售樓說明書必須顯示發展項目中所有住宅物業的樓面平面圖。在售樓說明書所載有關發展項目中住宅物業的每一份樓面平面圖，均須述明每個住宅物業的外部 and 內部尺寸<sup>2</sup>。售樓說明書所提供有關住宅物業外部和內部的尺寸，不會把批盪和裝飾物料包括在內。買家收樓前如欲購置家具，應留意這點。
- 親臨發展項目的所在地實地視察，以了解有關物業的四周環境(包括交通和社區設施)；亦應查詢有否任何城市規劃方案和議決，會對有關的物業造成影響；參閱載於售樓說明書內的位置圖、鳥瞰照片、分區計劃大綱圖，以及橫截面圖。

### 5. 售樓說明書

- 確保所取得的售樓說明書屬最新版本。根據條例，提供予公眾的售樓說明書必須是在之前的三個月之內印製或檢視、或檢視及修改。
- 如屬未落成發展項目，賣方在認為有需要時可改動建築圖則(如有的話)，因此應留意由賣方提供的任何經修改的售樓說明書，以了解有關未落成發展項目的最新資料。
- 閱覽售樓說明書，並須特別留意以下資訊：
  - 售樓說明書內有否關於「有關資料」的部分，列出賣方知悉但並非為一般公眾人士所知悉，關於相當可能對享有有關住宅物業造成重大影響的事宜的資料。請注意，已在土地註冊處註冊的文件，其內容不會被視為「有關資料」；
  - 橫截面圖會顯示有關建築物相對毗連該建築物的每條街道的橫截面，以及每條上述街道與已知基準面和該建築物最低的一層住宅樓層的水平相對的水平。橫截面圖能以圖解形式，顯示出建築物最低一層住宅樓層和街道水平的高低差距，不論該最低住宅樓層以何種方式命名；
  - 室內和外部的裝置、裝修物料和設備；
  - 管理費按甚麼基準分擔；
  - 小業主有否責任或需要分擔管理、營運或維持有關發展項目以內或以外的公眾休憩用地或公共設施的開支，以及有關公眾休憩用地或公共設施的位置；以及
  - 小業主是否須要負責維修斜坡。

### 6. 政府批地文件和公契

- 閱覽政府批地文件和公契(或公契擬稿)。公契內載有天台和外牆業權等相關資料。賣方會在售樓處提供政府批地文件和公契(或公契擬稿)的複本，供準買家免費閱覽。
- 留意政府批地文件內所訂明小業主是否須要負責支付地稅。
- 留意公契內訂明有關物業內可否飼養動物。

### 7. 售樓處內有關可供揀選住宅物業的資料

- 向賣方查詢清楚有哪些一手住宅物業可供揀選。若賣方在售樓處內展示「消耗表」，您可從該「消耗表」得悉在每個銷售日的銷售進度資料，包括在該個銷售日開始時有哪些住宅物業可供出售，以及在該個銷售日內有哪些住宅物業已獲揀選及售出。
- 切勿隨便相信有關發展項目銷情的傳言，倉卒簽立臨時買賣合約。

### 8. 成交紀錄冊

- 留意發展項目的成交紀錄冊。賣方須於臨時買賣合約訂立後的24小時內，於紀錄冊披露該臨時買賣合約的資料，以及於買賣合約訂立後一個工作天內，披露該買賣合約的資料。您可透過成交紀錄冊得悉發展項目的銷售情況。
- 切勿將賣方接獲用作登記的購樓意向書或本票的數目視為銷情指標。發展項目的成交紀錄冊才是讓公眾掌握發展項目每日銷售情況的最可靠資料來源。

### 9. 買賣合約

- 確保臨時買賣合約和買賣合約包含條例所規定的強制性條文。
- 留意有關物業買賣交易所包括的裝置、裝修物料和設備，須在臨時買賣合約和買賣合約上列明。
- 留意夾附於買賣合約的圖則。該圖則會顯示所有賣方售予您的物業面積，而該面積通常較該物業的實用面積為大。
- 留意賣方有權改動未落成發展項目的建築圖則(如有的話)。如屬未落成發展項目，條例規定物業的買賣合約須載有強制性條文，列明如有關改動在任何方面對該物業造成影響，賣方須在改動獲建築事務監督批准後的14日內，將該項改動以書面通知買家。
- 訂立臨時買賣合約時，您須向擁有人(即賣方)支付樓價5%的臨時訂金。
- 如您在訂立臨時買賣合約後五個工作日(工作日指並非公眾假日、星期六、黑色暴雨警告日或烈風警告日的日子)之內，沒有簽立買賣合約，該臨時買賣合約即告終止，有關臨時訂金(即樓價的5%)會被沒收，而擁有人(即賣方)不得因您沒有簽立買賣合約而對您提出進一步申索。

- 在訂立臨時買賣合約後的五個工作日之內，倘您簽立買賣合約，則擁有人(即賣方)必須在訂立該臨時買賣合約後的八個工作日之內簽立買賣合約。
- 有關的訂金，應付予負責為所涉物業擔任保證金保存人的律師事務所。

#### 10. 表達購樓意向

- 留意在賣方(包括其獲授權代表)就有關住宅物業向公眾提供價單前，賣方不得尋求或接納任何對有關住宅物業的購樓意向(不論是否屬明確選擇購樓意向)。因此您不應向賣方或其授權代表提出有關意向。
- 留意在有關住宅物業的銷售開始前，賣方(包括其獲授權代表)不得尋求或接納任何對該物業的有明確選擇購樓意向。因此您不應向賣方或其授權代表提出有關意向。

#### 11. 委託地產代理

- 留意倘賣方委任一個或多於一個地產代理，以協助銷售其發展項目內任何指明住宅物業，該發展項目的價單必須列明在價單印刷日期當日所有獲委任為地產代理的姓名/名稱。
- 您可委託任何地產代理(不一定是賣方所指定的地產代理)，以協助您購置發展項目內任何指明住宅物業；您亦可不委託任何地產代理。
- 委託地產代理以物色物業前，您應該—
  - 了解該地產代理是否只代表您行事。該地產代理若同時代表賣方行事，倘發生利益衝突，未必能夠保障您的最大利益；
  - 了解您須否支付佣金予該地產代理。若須支付，有關的佣金金額和支付日期為何；以及
  - 留意只有持牌地產代理或營業員才可以接受您的委託。如有疑问，應要求該地產代理或營業員出示其「地產代理證」，或瀏覽地產代理監管局的網頁(網址：www.eaa.org.hk)，查閱牌照目錄。

#### 12. 委聘律師

- 考慮自行委聘律師，以保障您的利益。該律師若同時代表賣方行事，倘發生利益衝突，未必能夠保障您的最大利益。
- 比較不同律師的收費。

#### 適用於一手未落成住宅物業

##### 13. 預售樓花同意書

- 洽購地政總署「預售樓花同意方案」下的未落成住宅物業時，應向賣方確認地政總署是否已就該發展項目批出「預售樓花同意書」。

##### 14. 示範單位

- 賣方不一定須設置示範單位供準買家或公眾參觀，但賣方如為某指明住宅物業設置示範單位，必須首先設置該住宅物業的無改動示範單位，才可設置該住宅物業的經改動示範單位，並可以就該住宅物業設置多於一個經改動示範單位。
- 參觀示範單位時，務必視察無改動示範單位，以便與經改動示範單位作出比較。然而，條例並沒有限制賣方安排參觀無改動示範單位及經改動示範單位的先後次序。
- 賣方設置示範單位供公眾參觀時，應已提供有關發展項目的售樓說明書。因此，緊記先行索取售樓說明書，以便在參觀示範單位時參閱相關資料。
- 您可以在無改動示範單位及經改動示範單位中進行量度，並在無改動示範單位內拍照或拍攝影片，惟在確保示範單位參觀者人身安全的前提下，賣方可能會設定合理的限制。

#### 適用於一手未落成住宅物業及尚待符合條件的已落成住宅物業

##### 15. 預計關鍵日期及收樓日期

- 查閱售樓說明書中有關發展項目的預計關鍵日期<sup>3</sup>。
  - 售樓說明書中有關發展項目的預計關鍵日期並不同買家的「收樓日期」。買家的「收樓日期」一般會較發展項目的預計關鍵日期遲。然而，假若發展項目比預期早落成，「收樓日期」可能會較售樓說明書列出的預計關鍵日期為早。
- 收樓日期
  - 條例規定買賣合約須載有強制性條文，列明賣方須於買賣合約內列出的預計關鍵日期後的14日內，以書面為發展項目申請佔用文件、合格證明書，或地政總署署長的轉讓同意(視屬何種情況而定)。
    - 如發展項目屬地政總署預售樓花同意方案所規管，賣方須在合格證明書或地政總署署長的轉讓同意發出後的一個月內(以較早者為準)，就賣方有能力有效地轉讓有關物業一事，以書面通知買家；或
    - 如發展項目並非屬地政總署預售樓花同意方案所規管，賣方須在佔用文件(包括佔用許可證)發出後的六個月內，就賣方有能力有效地轉讓有關物業一事，以書面通知買家。

- 條例規定買賣合約須載有強制性條文，列明有關物業的買賣須於賣方發出上述通知的日期的14日內完成。有關物業的買賣完成後，賣方將安排買家收樓事宜。

- 認可人士可批予在預計關鍵日期之後完成發展項目
  - 條例規定買賣合約須載有強制性條文，列明發展項目的認可人士可以在顧及純粹由以下一個或多於一個原因所導致的延遲後，批予在預計關鍵日期之後，完成發展項目：
    - 工人罷工或封閉工地；
    - 暴動或內亂；
    - 不可抗力或天災；
    - 火警或其他賣方所不能控制的意外；
    - 戰爭；或
    - 惡劣天氣。
  - 發展項目的認可人士可以按情況，多於一次批予延後預計關鍵日期以完成發展項目，即收樓日期可能延遲。
  - 條例規定買賣合約須載有強制性條文，列明賣方須於認可人士批予延期後的14日內，向買家提供有關延期證明書的文本。
    - 如對收樓日期有任何疑問，可向賣方查詢。

#### 適用於一手已落成住宅物業

##### 16. 賣方資料表格

- 確保取得最近三個月內印製有關您擬購買的一手已落成住宅物業的「賣方資料表格」。

##### 17. 參觀物業

- 購置住宅物業前，確保已獲安排參觀您打算購置的住宅物業。倘參觀有關物業並非合理地切實可行，則應參觀與有關物業相若的物業，除非您以書面同意賣方無須開放與有關物業相若的物業供您參觀。您應仔細考慮，然後才決定是否簽署豁免上述規定的書面同意。
- 除非有關物業根據租約持有，或為確保物業參觀者的人身安全而須設定合理限制，您可以對該物業進行量度、拍照或拍攝影片。

任何與賣方銷售受條例所規管的一手住宅物業有關的投訴和查詢，請與一手住宅物業銷售監管局聯絡。

網址：www.srpa.gov.hk  
 電話：2817 3313  
 電郵：enquiry\_srpa@hd.gov.hk  
 傳真：2219 2220

**其他相關聯絡資料：**

**消費者委員會**  
 網址：www.consumer.org.hk  
 電話：2929 2222  
 電郵：cc@consumer.org.hk  
 傳真：2856 3611

**地產代理監管局**  
 網址：www.eaa.org.hk  
 電話：2111 2777  
 電郵：enquiry@eaa.org.hk  
 傳真：2598 9596

**香港地產建設商會**  
 電話：2826 0111  
 傳真：2845 2521

**一手住宅物業銷售監管局**  
 2023年3月

**備註：**

1. 按揭貸款計劃的資料包括有關按揭貸款計劃對借款人的最低收入的要求、就第一按揭連同第二按揭可獲得的按揭貸款金額上限、最長還款年期、整個還款期內的按揭利率變化，以及申請人須繳付的手續費。
2. 根據條例附表1第1部第10(2)(d)條述明，售樓說明書內顯示的發展項目中的住宅物業的每一份樓面平面圖須述明以下各項—
  - (i) 每個住宅物業的外部尺寸；
  - (ii) 每個住宅物業的內部尺寸；
  - (iii) 每個住宅物業的內部間隔的厚度；
  - (iv) 每個住宅物業內個別分隔室的外部尺寸。
 根據條例附表1第1部第10(3)條，如有關發展項目的經批准的建築圖則，提供條例附表1第1部第10(2)(d)條所規定的資料，樓面平面圖須述明如此規定的該資料。
3. 一般而言，「關鍵日期」指該項目符合批地文件的條件的日期，或該項目在遵照經批准的建築圖則的情況下或按照豁免證明書的發出的條件在各方面均屬完成的日期。有關詳情請參閱條例第2條。



**Name of the Phase of the Development**

Phase 1 of Gold Coast Bay is called “The Uppland”

**Name of the street at which the Phase is situated and the street number allocated by the Commissioner of Rating and Valuation for the purpose of distinguishing the Phase**

18 Castle Peak Road - Castle Peak Bay\*

Note:

\*This provisional street number is subject to confirmation when the Phase is completed.

**Total number of storeys of each multi-unit building**

Tower 3 & Tower 5 (5A and 5B): 23 storeys

Note:

- The above number of storeys includes G/F, 1/F and Podium Floor
- The above number of storeys excludes Transfer Plate, Roof, Upper Roof and Top Roof

**Floor numbering in each multi-unit building as provided in the approved building plans for the Phase**

Tower 3 & Tower 5 (5A and 5B): G/F, 1/F, Podium Floor, Transfer Plate, 3/F, 5/F-12/F, 15/F-23/F, 25/F-26/F, Roof, Upper Roof and Top Roof

**Omitted floor numbers in each multi-unit building in which the floor numbering is not in consecutive order**

Tower 3 & Tower 5 (5A and 5B): 4/F, 13/F, 14/F and 24/F

**Refuge floors (if any) of each multi-unit building**

Tower 3 & Tower 5 (5A and 5B): Not applicable

**Estimated material date for the Phase as provided by the Authorized Person for the Phase**

21 November 2025

The above estimated material date is subject to any extension of time that is permitted under the agreement for sale and purchase.

Under the land grant, the consent of the Director of Lands is required to be given for the sale and purchase. For the purpose of the agreement for sale and purchase, without limiting any other means by which the completion of the Phase may be proved, the issue of a certificate of compliance or consent to assign by the Director of Lands is conclusive evidence that the Phase has been completed or is deemed to be completed (as the case may be).

Note:

“material date” means the date on which the conditions of the land grant are complied with in respect of the Phase.

**發展項目的期數的名稱**

黃金海灣的第1期稱為「意嵐」

**期數所位於的街道名稱及由差餉物業估價署署長為識別期數的目的而編配的門牌號數**

青山公路 - 青山灣段 18 號 \*

備註：

\* 此臨時門牌號數有待期數建成時確認。

**每幢多單位建築物的樓層總數**

第3座及第5座(5A及5B)：23層

備註：

- 上述樓層數目包括地下、1樓及平台層
- 上述樓層數目不包括轉換層、天台、上層天台及頂層天台

**期數的經批准的建築圖則所規定的每幢多單位建築物內的樓層號數**

第3座及第5座(5A及5B)：地下、1樓、平台層、轉換層、3樓、5樓至12樓、15樓至23樓、25樓至26樓、天台、上層天台及頂層天台

**每幢有不依連續次序的樓層號數的多單位建築物內被略去的樓層號數**

第3座及第5座(5A及5B)：4樓、13樓、14樓及24樓

**每幢多單位建築物內的庇護層(如有的話)**

第3座及第5座(5A及5B)：不適用

**期數的認可人士提供的期數的預計關鍵日期**

2025年11月21日

上述預計關鍵日期，是受到買賣合約所允許的任何延期所規限的。

根據批地文件，進行該項買賣，需獲地政總署署長同意。為買賣合約的目的，在不局限任何其他可用以證明期數落成的方法的原則下，地政總署署長發出的合格證明書或轉讓同意，即為期數已落成或當作已落成(視屬何情況而定)的確證。

備註：

「關鍵日期」指批地文件的條件就期數而獲符合的日期。

**Vendor**

Ocean Regal Limited

**Holding Companies of the Vendor**

Victory Valley Limited  
United View Developments Limited  
Richset Global Limited  
Early Light International Property Development (HK) Limited  
Early Light International Property Development Limited  
Early Light International Properties Limited  
Early Light International Estates Limited

**Authorized Person for the Phase**

Lee Ming Yen Jennifer

**The firm or corporation of which an Authorized Person for the Phase is proprietor, director or employee in his or her professional capacity**

P&T Architects Limited

**Building contractor for the Phase**

Unistress Building Construction Limited

**The firms of solicitors acting for the owner in relation to the sale of residential properties in the Phase**

Deacons  
Baker & McKenzie

**Authorized institutions that have made a loan, or have undertaken to provide finance, for the construction of the Phase**

China CITIC Bank International Limited  
The Bank of East Asia, Limited

**Any other person who has made a loan for the construction of the Phase**

Not applicable

**賣方**

海琪有限公司

**賣方的控權公司**

勝谷有限公司  
合景發展有限公司  
立豐環球有限公司  
旭日國際地產發展(香港)有限公司  
旭日國際地產發展有限公司  
旭日國際地產有限公司  
旭日國際置業有限公司

**期數的認可人士**

李明嫻

**期數的認可人士以其專業身分擔任經營人、董事或僱員的商號或法團**

巴馬丹拿建築師有限公司

**期數的承建商**

聯力建築有限公司

**就期數中的住宅物業的出售而代表擁有人行事的律師事務所的近律師行**

貝克 • 麥堅時律師事務所

**已為期數的建造提供貸款或已承諾為該項建造提供融資的認可機構**

中信銀行(國際)有限公司  
東亞銀行有限公司

**已為期數的建造提供貸款的任何其他人**

不適用

(a) The Vendor or a building contractor for the Phase is an individual, and that Vendor or contractor is an immediate family member of an Authorized Person for the Phase; 賣方或有關期數的承建商屬個人，並屬該期數的認可人士的家人；	Not applicable 不適用
(b) The Vendor or a building contractor for the Phase is a partnership, and a partner of that Vendor or contractor is an immediate family member of such an Authorized Person; 賣方或該期數的承建商屬合夥，而該賣方或承建商的合夥人屬上述認可人士的家人；	Not applicable 不適用
(c) The Vendor or a building contractor for the Phase is a corporation, and a director or the secretary of that Vendor or contractor (or a holding company of that Vendor) is an immediate family member of such an Authorized Person; 賣方或該期數的承建商屬法團，而該賣方或承建商(或該賣方的控股公司)的董事或秘書屬上述認可人士的家人；	No 否
(d) The Vendor or a building contractor for the Phase is an individual, and that Vendor or contractor is an immediate family member of an associate of such an Authorized Person; 賣方或該期數的承建商屬個人，並屬上述認可人士的有聯繫人士的家人；	Not applicable 不適用
(e) The Vendor or a building contractor for the Phase is a partnership, and a partner of that Vendor or contractor is an immediate family member of an associate of such an Authorized Person; 賣方或該期數的承建商屬合夥，而該賣方或承建商的合夥人屬上述認可人士的有聯繫人士的家人；	Not applicable 不適用
(f) The Vendor or a building contractor for the Phase is a corporation, and a director or the secretary of that Vendor or contractor (or a holding company of that Vendor) is an immediate family member of an associate of such an Authorized Person; 賣方或該期數的承建商屬法團，而該賣方或承建商(或該賣方的控股公司)的董事或秘書屬上述認可人士的有聯繫人士的家人；	No 否
(g) The Vendor or a building contractor for the Phase is an individual, and that Vendor or contractor is an immediate family member of a proprietor of a firm of solicitors acting for the owner in relation to the sale of residential properties in the Phase; 賣方或該期數的承建商屬個人，並屬就該期數內的住宅物業的出售代表擁有人行事的律師事務所行事的經營人的家人；	Not applicable 不適用
(h) The Vendor or a building contractor for the Phase is a partnership, and a partner of that Vendor or contractor is an immediate family member of a proprietor of a firm of solicitors acting for the owner in relation to the sale of residential properties in the Phase; 賣方或該期數的承建商屬合夥，而該賣方或承建商的合夥人屬就該期數內的住宅物業的出售代表擁有人行事的律師事務所行事的經營人的家人；	Not applicable 不適用
(i) The Vendor or a building contractor for the Phase is a corporation, and a director or the secretary of that Vendor or contractor (or a holding company of that Vendor) is an immediate family member of a proprietor of such a firm of solicitors; 賣方或該期數的承建商屬法團，而該賣方或承建商(或該賣方的控股公司)的董事或秘書屬上述律師事務所的經營人的家人；	No 否

(j) The Vendor, a holding company of the Vendor, or a building contractor for the Phase, is a private company, and an Authorized Person for the Phase, or an associate of such an Authorized Person, holds at least 10% of the issued shares in that Vendor, holding company or contractor; 賣方、賣方的控股公司或有關期數的承建商屬私人公司，而該期數的認可人士或該認可人士的有聯繫人士持有該賣方、控股公司或承建商最少10%的已發行股份；	No 否
(k) The Vendor, a holding company of the Vendor, or a building contractor for the Phase, is a listed company, and such an Authorized Person, or such an associate, holds at least 1% of the issued shares in that Vendor, holding company or contractor; 賣方、賣方的控股公司或該期數的承建商屬上市公司，而上述認可人士或上述有聯繫人士持有該賣方、控股公司或承建商最少1%的已發行股份；	Not applicable 不適用
(l) The Vendor or a building contractor for the Phase is a corporation, and such an Authorized Person, or such an associate, is an employee, director or secretary of that Vendor or contractor or of a holding company of that Vendor; 賣方或該期數的承建商屬法團，而上述認可人士或上述有聯繫人士屬該賣方、承建商或該賣方的控股公司的僱員、董事或秘書；	No 否
(m) The Vendor or a building contractor for the Phase is a partnership, and such an Authorized Person, or such an associate, is an employee of that Vendor or contractor; 賣方或該期數的承建商屬合夥，而上述認可人士或上述有聯繫人士屬該賣方或承建商的僱員；	Not applicable 不適用
(n) The Vendor, a holding company of the Vendor, or a building contractor for the Phase, is a private company, and a proprietor of a firm of solicitors acting for the owner in relation to the sale of residential properties in the Phase holds at least 10% of the issued shares in that Vendor, holding company or contractor; 賣方、賣方的控股公司或該期數的承建商屬私人公司，而就該期數中的住宅物業的出售而代表擁有人行事的律師事務所的經營人持有該賣方、控股公司或承建商最少10%的已發行股份；	No 否
(o) The Vendor, a holding company of the Vendor, or a building contractor for the Phase, is a listed company, and a proprietor of such a firm of solicitors holds at least 1% of the issued shares in that Vendor, holding company or contractor; 賣方、賣方的控股公司或該期數的承建商屬上市公司，而上述律師事務所的經營人持有該賣方、控股公司或承建商最少1%的已發行股份；	Not applicable 不適用
(p) The Vendor or a building contractor for the Phase is a corporation, and a proprietor of such a firm of solicitors is an employee, director or secretary of that Vendor or contractor or of a holding company of that Vendor; 賣方或該期數的承建商屬法團，而上述律師事務所的經營人屬該賣方或承建商或該賣方的控股公司的僱員、董事或秘書；	No 否
(q) The Vendor or a building contractor for the Phase is a partnership, and a proprietor of such a firm of solicitors is an employee of that Vendor or contractor; 賣方或該期數的承建商屬合夥，而上述律師事務所的經營人屬該賣方或承建商的僱員；	Not applicable 不適用

<p>(r) The Vendor or a building contractor for the Phase is a corporation, and the corporation of which an Authorized Person for the Phase is a director or employee in his or her professional capacity is an associate corporation of that Vendor or contractor or of a holding company of that Vendor; 賣方或該期數的承建商屬法團，而該期數的認可人士以其專業身分擔任董事或僱員的法團為該賣方或承建商或該賣方的控權公司的有聯繫法團；</p>	<p>No 否</p>
<p>(s) The Vendor or a building contractor for the Phase is a corporation, and that contractor is an associate corporation of that Vendor or of a holding company of that Vendor. 賣方或該期數的承建商屬法團，而該承建商屬該賣方或該賣方的控權公司的有聯繫法團。</p>	<p>No 否</p>

There will be non-structural prefabricated external walls forming part of the enclosing walls of the Phase.  
期數將會有構成圍封牆的一部分的非結構的預製外牆。

The range of thickness of the non-structural prefabricated external walls of each block will be 150mm.  
每幢建築物的非結構的預製外牆的厚度範圍將為 150 毫米。

There will be curtain walls forming part of the enclosing walls of the Phase.  
期數將會有構成圍封牆的一部分的幕牆。

The range of thickness of the curtain walls of each block will be 200mm.  
每幢建築物的幕牆的厚度範圍將為 200 毫米。

Tower 座	Floor 樓層	Unit 單位	Total area of non-structural prefabricated external walls of each residential property (sq.m.) 每個住宅物業的非結構的預製外牆的總面積 (平方米)	Total area of curtain walls of each residential property (sq.m.) 每個住宅物業的幕牆的總面積 (平方米)
Tower 3 第3座	3/F 3樓	B	0.348	0.761
		C	0.357	0.792
		D	0.348	0.801
		E	0.348	0.761
		F	0.348	0.731
		G	0.914	1.150
		H	1.169	0.615
		J	0.931	0.833
		K	0.931	0.833
	5/F 5樓	A	1.628	1.515
		B	0.348	0.761
		C	0.357	0.792
		D	0.348	0.801
		E	0.348	0.761
		F	0.348	0.731
		G	1.037	1.150
		H	1.169	0.615
		J	0.931	0.833
		K	0.931	0.833
		M	0.931	0.673
N	0.803	0.833		

Note: 4/F, 13/F, 14/F and 24/F are omitted.

Tower 座	Floor 樓層	Unit 單位	Total area of non-structural prefabricated external walls of each residential property (sq.m.) 每個住宅物業的非結構的預製外牆的總面積 (平方米)	Total area of curtain walls of each residential property (sq.m.) 每個住宅物業的幕牆的總面積 (平方米)
Tower 3 第3座	6/F - 12/F, 15/F - 23/F & 25/F 6樓至 12樓、15樓 至23樓及 25樓	A	1.628	1.515
		B	0.348	0.761
		C	0.357	0.792
		D	0.348	0.801
		E	0.348	0.761
		F	0.348	0.731
		G	1.037	1.150
		H	1.169	0.615
		J	0.931	0.833
		K	0.931	0.833
		M	0.931	0.833
	N	1.006	0.833	
	26/F 26樓	A	1.628	1.515
		B	0.348	0.761
		C	0.357	0.792
		D	0.348	0.801
		E	0.348	0.761
		F	0.348	0.731
		G	1.037	1.150
		H	1.169	0.615
J		0.931	0.833	
K	0.931	0.833		
M	0.931	0.833		
N	1.006	0.833		

備註：不設 4 樓、13 樓、14 樓及 24 樓。

Tower 座	Floor 樓層	Unit 單位	Total area of non-structural prefabricated external walls of each residential property (sq.m.) 每個住宅物業的非結構的 預製外牆的總面積 (平方米)	Total area of curtain walls of each residential property (sq.m.) 每個住宅物業的幕牆的 總面積 (平方米)
Tower 5 (5A) 第5座 (5A)	3/F 3樓	A	0.670	1.237
		B	0.348	0.825
		C	1.369	1.802
		D	0.303	0.828
		E	0.331	0.783
		F	0.303	0.395
		G	0.284	0.395
		M	0.000	0.323
		N	0.000	0.348
		P	0.276	0.420
		Q	0.287	0.428
	5/F 5樓	A	0.670	1.237
		B	0.348	0.825
		C	1.369	1.802
		D	0.303	0.828
		E	0.331	0.783
		F	0.303	0.395
		G	0.284	0.395
		J	0.272	0.391
		K	0.000	0.311
		M	0.000	0.333
		N	0.000	0.323
P	0.276	0.445		
Q	0.287	0.428		
R	0.300	0.458		

Tower 座	Floor 樓層	Unit 單位	Total area of non-structural prefabricated external walls of each residential property (sq.m.) 每個住宅物業的非結構的 預製外牆的總面積 (平方米)	Total area of curtain walls of each residential property (sq.m.) 每個住宅物業的幕牆的 總面積 (平方米)
Tower 5 (5A) 第5座 (5A)	6/F 6樓	A	0.670	1.237
		B	0.348	0.825
		C	1.369	1.802
		D	0.303	0.828
		E	0.331	0.783
		F	0.303	0.395
		G	0.284	0.395
		H	0.282	0.417
		J	0.272	0.416
		K	0.000	0.311
		M	0.000	0.333
		N	0.000	0.323
		P	0.276	0.445
		Q	0.287	0.428
	R	0.300	0.458	
	7/F 7樓	A	0.670	1.237
		B	0.348	0.825
		C	1.369	1.802
		D	0.303	0.828
		E	0.331	0.783
		F	0.303	0.395
		G	0.284	0.395
		H	0.285	0.417
		J	0.272	0.416
		K	0.000	0.311
		M	0.000	0.333
		N	0.000	0.323
		P	0.276	0.445

Note: 4/F, 13/F, 14/F and 24/F are omitted.

備註：不設4樓、13樓、14樓及24樓。

Tower 座	Floor 樓層	Unit 單位	Total area of non-structural prefabricated external walls of each residential property (sq.m.) 每個住宅物業的非結構的 預製外牆的總面積 (平方米)	Total area of curtain walls of each residential property (sq.m.) 每個住宅物業的幕牆的 總面積 (平方米)
Tower 5 (5A) 第5座 (5A)	8/F 8樓	A	0.670	1.237
		B	0.348	0.825
		C	1.369	1.802
		D	0.303	0.828
		E	0.331	0.783
		F	0.303	0.395
		G	0.284	0.395
		H	0.285	0.417
		J	0.272	0.416
		K	0.000	0.311
		M	0.000	0.333
		N	0.000	0.323
		P	0.276	0.445
		9/F 9樓	A	0.670
	B		0.348	0.825
	C		1.369	1.802
	D		0.303	0.828
	E		0.331	0.783
	F		0.303	0.395
	G		0.284	0.395
	H		0.285	0.417
	J		0.272	0.416
	K		0.000	0.311
	M		0.000	0.333
	N		0.000	0.323
	P	0.276	0.445	

Tower 座	Floor 樓層	Unit 單位	Total area of non-structural prefabricated external walls of each residential property (sq.m.) 每個住宅物業的非結構的 預製外牆的總面積 (平方米)	Total area of curtain walls of each residential property (sq.m.) 每個住宅物業的幕牆的 總面積 (平方米)
Tower 5 (5A) 第5座 (5A)	10/F - 12/F, 15/F - 23/F & 25/F 10樓至 12樓、15樓 至23樓及 25樓	A	0.670	1.237
		B	0.348	0.825
		C	1.369	1.802
		D	0.303	0.828
		E	0.331	0.783
		F	0.303	0.395
		G	0.284	0.395
		H	0.285	0.417
		J	0.272	0.416
		K	0.000	0.311
		M	0.000	0.333
		N	0.000	0.323
		P	0.276	0.445
		26/F 26樓	A	0.670
	B		0.348	0.825
	C		1.369	1.802
	D		0.303	0.828
	E		0.331	0.783
	F		0.303	0.395
	G		0.284	0.395
	H		0.285	0.417
	J		0.272	0.416
	K		0.000	0.311
	M		0.000	0.333
	N		0.000	0.323
	P	0.276	0.445	

Note: 4/F, 13/F, 14/F and 24/F are omitted.

備註：不設4樓、13樓、14樓及24樓。

Tower 座	Floor 樓層	Unit 單位	Total area of non-structural prefabricated external walls of each residential property (sq.m.) 每個住宅物業的非結構的 預製外牆的總面積 (平方米)	Total area of curtain walls of each residential property (sq.m.) 每個住宅物業的幕牆的 總面積 (平方米)
Tower 5 (5B) 第5座 (5B)	7/F 7樓	A	0.287	0.428
		B	0.300	0.458
		C	0.000	0.381
		J	0.000	0.333
		K	0.011	0.311
		M	0.279	0.463
		N	0.285	0.439
	8/F 8樓	A	0.287	0.428
		B	0.300	0.458
		C	0.000	0.301
		J	0.000	0.333
		K	0.011	0.311
		M	0.279	0.463
		N	0.285	0.439
	9/F 9樓	A	0.287	0.428
		B	0.300	0.458
		C	0.000	0.363
		D	0.000	0.323
		E	0.000	0.385
		F	0.853	0.498
		G	0.849	0.424
		H	0.000	0.318
		J	0.000	0.333
		K	0.011	0.311
		M	0.279	0.463
		N	0.285	0.439

Tower 座	Floor 樓層	Unit 單位	Total area of non-structural prefabricated external walls of each residential property (sq.m.) 每個住宅物業的非結構的 預製外牆的總面積 (平方米)	Total area of curtain walls of each residential property (sq.m.) 每個住宅物業的幕牆的 總面積 (平方米)	
Tower 5 (5B) 第5座 (5B)	10/F - 12/F, 15/F - 23/F & 25/F 10樓至 12樓、15樓 至23樓及 25樓	A	0.287	0.428	
		B	0.300	0.458	
		C	0.000	0.363	
		D	0.000	0.323	
		E	0.000	0.385	
		F	1.187	0.498	
		G	0.849	0.424	
		H	0.000	0.318	
		J	0.000	0.333	
		K	0.011	0.311	
		M	0.279	0.463	
		N	0.285	0.439	
		26/F 26樓	A	0.287	0.428
			B	0.300	0.458
	C		0.000	0.363	
	D		0.000	0.323	
	E		0.000	0.385	
	F		1.187	0.498	
	G		0.849	0.424	
	H		0.000	0.318	
	J		0.000	0.333	
	K		0.011	0.311	
	M		0.279	0.463	
	N		0.285	0.439	

Note: 4/F, 13/F, 14/F and 24/F are omitted.

備註：不設4樓、13樓、14樓及24樓。



**Person appointed as the Manager of the Phase under the latest draft Deed of Mutual Covenant:**  
Savills Property Management Limited

根據有關公契的最新擬稿，獲委任為期數的管理人的人：  
第一太平戴維斯物業管理有限公司

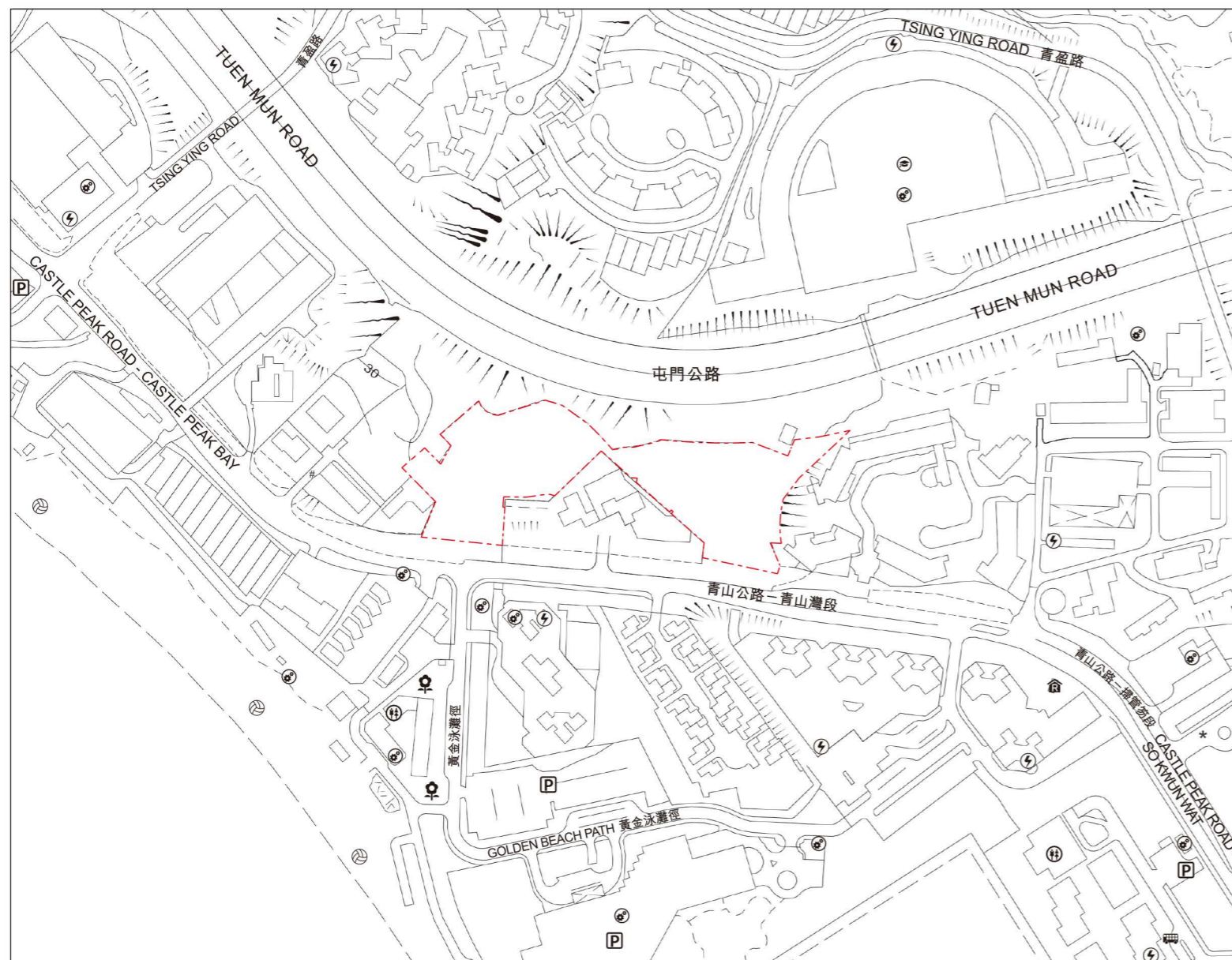

Boundary of the Development  
發展項目邊界

Scale 0 250M/米  
比例

Street name(s) not shown in full in the Location Plan of the Development:  
於發展項目的所在位置圖未能顯示之街道全名：

# 滿發里 MUN FAT LANE \* 管青路 KWUN TSING ROAD

The map is provided by the Common Spatial Data Infrastructure (CSDI) Portal and Intellectual property rights are owned by the Government of the HKSAR.

地圖由空間數據共享平台提供，香港特別行政區政府為知識產權擁有人。

Notes:

1. The Vendor advises prospective purchasers to conduct an on-site visit for a better understanding of the Development site, its surrounding environment and the public facilities nearby.
2. The plan may show more than the area required under the Residential Properties (First-hand Sales) Ordinance due to the technical reason that the boundary of the Development is irregular.

N 北 This Location Plan is prepared by the Vendor with reference to the Digital Topographic Map No. T6-SW-C dated 15 August 2024 from Survey and Mapping Office of the Lands Department, with adjustments where necessary.

此位置圖是由賣方擬備並參考地政總署測繪處於2024年8月15日出版之數碼地形圖，圖幅編號 T6-SW-C，有需要處經修正處理。

NOTATION 圖例

-  A Power Plant (Including Electricity Sub-stations)  
發電廠 (包括電力分站)
-  A Public Utility Installation  
公用事業設施裝置
-  A Public Convenience  
公廁
-  A School (Including a Kindergarten)  
學校 (包括幼稚園)
-  A Public Carpark (Including a Lorry Park)  
公眾停車場 (包括貨車停泊處)
-  Sports Facilities (Including a Sports Ground and a Swimming Pool)  
體育設施 (包括運動場及游泳池)
-  A Public Park  
公園
-  A Religious Institution (Including a Church, a Temple and a Tsz Tong)  
宗教場所 (包括教堂、廟宇及祠堂)
-  A Public Transport Terminal (Including a Rail Station)  
公共交通總站 (包括鐵路車站)

備註：

1. 賣方建議準買家到該發展地盤作實地考察，以對該發展地盤、其周邊地區環境及附近的公共設施有較佳了解。
2. 由於發展項目的邊界不規則的技術原因，此圖所顯示的範圍可能超過《一手住宅物業銷售條例》所規定的範圍。



N Adopted from part of the aerial photograph taken by the Survey and Mapping Office, Lands Department  
北 at a flying height of 6,900 feet, photograph no. E213316C, date of flight: 28th November 2023.

摘錄自地政總署測繪處在6,900呎的飛行高度拍攝之鳥瞰照片，照片編號 E213316C，飛行日期：  
2023年11月28日。

● Location of the Phase  
期數的位置

Survey and Mapping Office, Lands Department, The Government of Hong Kong SAR © Copyright reserved  
- reproduction by permission only.

香港特別行政區政府地政總署測繪處 © 版權所有，未經許可，不得複製。

Notes:

1. Copy of the aerial photograph of the Phase is available for free inspection at the sales office during opening hours.
2. The aerial photograph may show more than the area required under the Residential Properties (First-hand Sales) Ordinance due to technical reason that the boundary of the Phase is irregular.
3. The Vendor advises prospective purchasers to conduct on-site visit for a better understanding of the Phase, its surrounding environment and the public facilities nearby.

備註：

1. 期數的鳥瞰照片之副本可於售樓處開放時間內免費查閱。
2. 由於期數的邊界不規則的技術原因，此照片所顯示的範圍可能超過《一手住宅物業銷售條例》所規定的範圍。
3. 賣方建議準買方到有關期數作實地考察，以對該期數、其周邊地區環境及附近的公共設施有較佳了解。

刪除此頁並換上空頁。

**This page is deleted and replaced with a blank page.**

**刪除此頁並換上空頁。**

**This page is deleted and replaced with a blank page.**

刪除此頁並換上空頁。

**This page is deleted and replaced with a blank page.**



Adopted from part of the Draft Tuen Mun Outline Zoning Plan No. S/TM/39 gazetted on 26 July 2024, with adjustments where necessary as shown in red.  
 摘錄自2024年7月26日刊憲之屯門分區計劃大綱草圖，有需要處經修正處理，以紅色顯示。

**NOTATION 圖例**  
**ZONES**

ZONES	Symbol	地帶
RESIDENTIAL (GROUP B)	R(B)	住宅(乙類)
VILLAGE TYPE DEVELOPMENT	V	鄉村式發展
GOVERNMENT, INSTITUTION OR COMMUNITY	G/IC	政府、機構或社區
OPEN SPACE	O	休憩用地
OTHER SPECIFIED USES	OU	其他指定用途
GREEN BELT	GB	綠化地帶

**COMMUNICATIONS**

COMMUNICATIONS	Symbol	交通
MAJOR ROAD AND JUNCTION	[Symbol]	主要道路及路口
ELEVATED ROAD	[Symbol]	高架道路

**MISCELLANEOUS**

MISCELLANEOUS	Symbol	其他
BOUNDARY OF PLANNING SCHEME	[Symbol]	規劃範圍界線
PLANNING AREA NUMBER	(1)	規劃區編號
BUILDING HEIGHT CONTROL ZONE BOUNDARY	[Symbol]	建築物高度管制區界線
MAXIMUM BUILDING HEIGHT (IN METRES ABOVE PRINCIPAL DATUM)	[Symbol]	最高建築物高度 (在主水平基準上若干米)
MAXIMUM BUILDING HEIGHT RESTRICTION AS STIPULATED ON THE NOTES	[Symbol]	《註釋》內定明最高建築物高度限制
MAXIMUM BUILDING HEIGHT (IN NUMBER OF STOREYS)	[Symbol]	最高建築物高度 (樓層數目)

**★** This area is not covered under Outline Zoning Plan or Development Permission Area Plan, or the plan deemed to be a draft plan.  
 此地區並不納入分區計劃大綱圖或發展審批地區圖，或被當作草圖的圖則。

The plan, prepared by the Planning Department under the direction of the Town Planning Board, is reproduced with the permission of the Director of Lands. © The Government of Hong Kong SAR.  
 大綱圖為規劃署遵照城市規劃委員會指示擬備，版權屬香港特區政府，經地政總署准許複印。

- Notes:
1. The last updated Outline Zoning Plan and the attached schedule as at the date of printing of the sales brochure is available for free inspection at the sales office during opening hours.
  2. The Vendor advises prospective purchasers to conduct an on-site visit for a better understanding of the Development site, its surrounding environment and the public facilities nearby.
  3. The plan may show more than the area required under the Residential Properties (First-hand Sales) Ordinance due to technical reason that the boundary of the Development is irregular.

- 備註:
1. 在印刷售樓說明書當日所適用的最近期分區計劃大綱圖及其附表，可於售樓處開放時間內免費查閱。
  2. 賣方建議準買家到有關發展地盤作實地考察，以對該發展地盤、其周邊地區環境及附近的公共設施有較佳了解。
  3. 由於發展項目的邊界不規則的技術原因，此圖所顯示的範圍可能超過《一手住宅物業銷售條例》所規定的範圍。

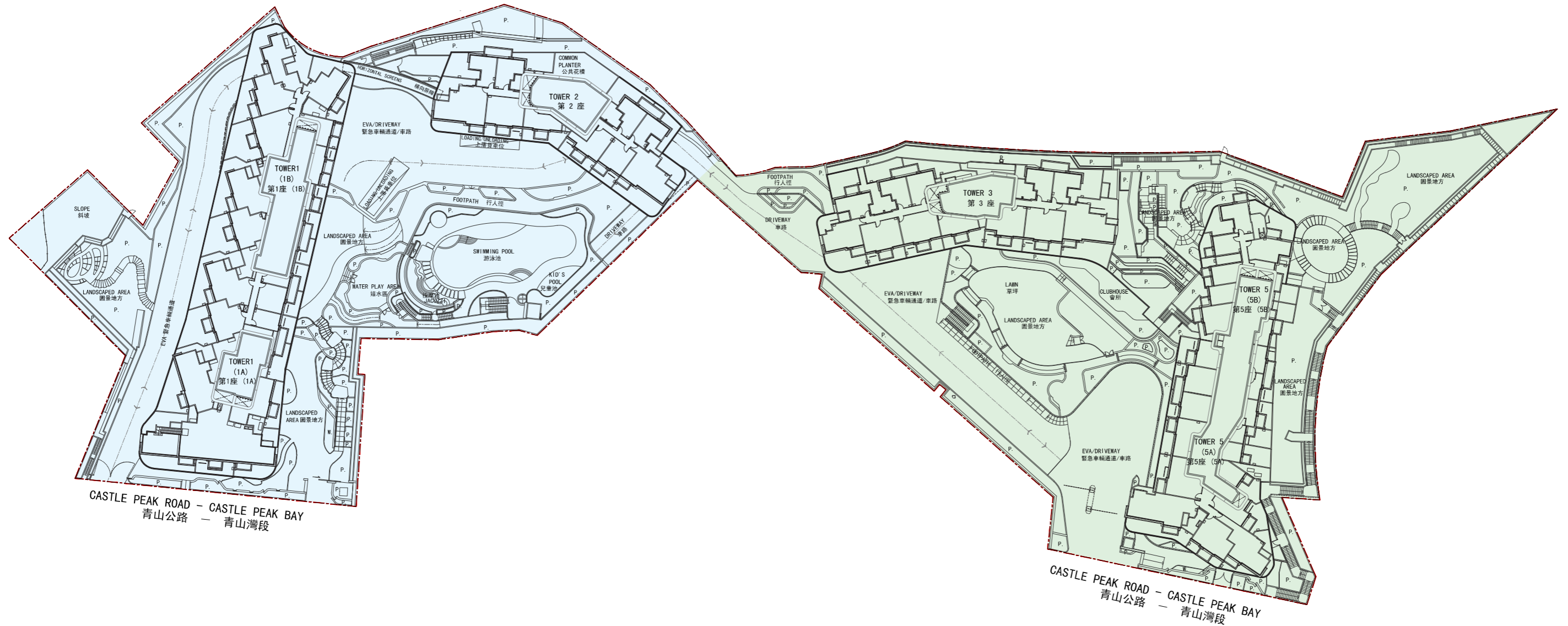

**LEGEND 圖例**

- Boundary of the Development  
發展項目邊界
- Phase 1 of the Development  
發展項目第1期
- Phase 2 of the Development  
發展項目第2期
- EVA = Emergency Vehicular Access = 緊急車輛通道
- P. = PLANTER = 花槽
- W. = WATER FEATURE = 水景

The estimated date of the completion of the buildings and facilities within Phase 1 of the Development as provided by the Authorized Person for Phase 1 of the Development is 21<sup>st</sup> May 2025.  
由發展項目第1期的認可人士提供的位於發展項目第1期內的建築物及設施的預計落成日期為2025年5月21日。

The estimated date of the completion of the buildings and facilities within Phase 2 of the Development as provided by the Authorized Person for Phase 2 of the Development is 21<sup>st</sup> May 2025.  
由發展項目第2期的認可人士提供的位於發展項目第2期內的建築物及設施的預計落成日期為2025年5月21日。





## LEGEND OF THE TERMS AND ABBREVIATIONS USED ON FLOOR PLANS

樓面平面圖中所使用之名詞及簡稱之圖例

_ /F BUILDING LINE ABOVE	= _ 樓上方建築線	COVERED LANDSCAPED	= COVERED LANDSCAPED AREA	= 有蓋園景地方
_ /F TRANSFER PLATE	= _ 樓轉換層	COVERED LANDSCAPED & PLAY AREA	= COVERED LANDSCAPED AND PLAY AREA	= 有蓋園景及遊樂地方
A.C.P.	= AIR CONDITIONER PLATFORM	DIN.	= DINING ROOM	= 飯廳
A/C UNIT FOR T3 _	= AIR CONDITIONER UNIT FOR TOWER 3 _	DOG HOUSE		= 室外管道房
A/C UNIT FOR T5A _	= AIR CONDITIONER UNIT FOR TOWER 5 (5A) _	EAD	= EXHAUST AIR DUCT	= 排氣管道
ACC. LIFT	= ACCESSIBLE LIFT	ELECT. DUCT	= ELECTRIC DUCT	= 電氣槽
BAL.	= BALCONY	ELECT. METER RM.	= ELECTRIC METER ROOM	= 電錶房
BAL. ABOVE	= BALCONY ABOVE	ELV. DUCT	= EXTRA-LOW VOLTAGE DUCT	= 特低壓電槽
BAL. & A.C.P. ABOVE	= BALCONY AND AIR CONDITIONER PLATFORM ABOVE	FAD	= FRESH AIR DUCT	= 鮮風管道
BAL./U.P./A.C.P. ABOVE	= BALCONY / UTILITY PLATFORM / AIR CONDITIONER PLATFORM ABOVE	FAN RM	= FAN ROOM	= 風機房
BATH	= BATHROOM	F.H.	= FIRE HYDRANT	= 消防栓
BED RM.	= BEDROOM	FLAT ROOF		= 平台
BED RM. _	= BEDROOM _	FLAT ROOF BELOW		= 下層平台
BUILDING LINE ABOVE	= 上方建築線	FLUSHING WATER PUMP RM.	= FLUSHING WATER PUMP ROOM	= 沖廁水泵房
CABD RM.	= COMMUNAL AERIAL BROADCAST DISTRIBUTION ROOM	FOR _ /F		= 設於 _ 樓
CAT LADDER W/ SAFETY CAGE	= CAT LADDER WITH SAFETY CAGE	FOR _ /F - _ /F		= 設於 _ 樓至 _ 樓
CLUBHOUSE	= 會所	GAS DUCT		= 煤氣槽
COMMON PLANTER	= 公用花槽	GARDEN		= 花園
COMMON PLANTER BELOW	= 下層公用花槽	H.R.	= HOSE REEL	= 消防喉轆
COVER OF BAL.	= COVER OF BALCONY	H.R. AT H/L	= HOSE REEL AT HIGH LEVEL	= 上方消防喉轆
COVER OF BAL./ U.P./ A.C.P.	= COVER OF BALCONY / UTILITY PLATFORM / AIR CONDITIONER PLATFORM	I.C.F.R.	= INACCESSIBLE COMMON FLAT ROOF	= 維修平台
COVER OF U.P.	= COVER OF UTILITY PLATFORM	KIT.	= KITCHEN	= 廚房
		LAWN		= 草坪
		LANDSCAPED AREA		= 園景地方

## LEGEND OF THE TERMS AND ABBREVIATIONS USED ON FLOOR PLANS

樓面平面圖中所使用之名詞及簡稱之圖例

LIFT		= 升降機	P.D.	= PIPE DUCT	= 管道槽
LIFT LOBBY		= 升降機大堂	PLANTER (BELOW)		= 下方花槽
LIFT OVER-RUN		= 升降機槽	POTABLE WATER PUMP RM.	= POTABLE WATER PUMP ROOM	= 食水泵房
LIFT SHAFT		= 升降機井	RAINWATER HARVESTING WATER TANK & PUMP AND IRRIGATION WATER TANK & PUMP ROOM		= 雨水收集水箱連泵房及灌溉水箱連泵房
LIV.	= LIVING ROOM	= 客廳	ROOF		= 天台
LIV./DIN.	= LIVING ROOM AND DINING ROOM	= 客廳及飯廳	R.S. & M.R.	= REFUSE STORAGE AND MATERIAL RECOVERY ROOM	= 垃圾及物料回收室
M. BED RM.	= MASTER BEDROOM	= 主人睡房	R.C. A.F.	= REINFORCED CONCRETE ARCHITECTURAL FEATURE	= 混凝土建築裝飾
M. BATH	= MASTER BATHROOM	= 主人浴室	R.C. A.F. ABOVE	= REINFORCED CONCRETE ARCHITECTURAL FEATURE ABOVE	= 上方混凝土建築裝飾
MAINTENANCE SPACE FOR BUILDING SERVICES		= 建築設備維修空間	SINK		= 洗滌盆
METAL A.F.	= METAL ARCHITECTURAL FEATURE	= 金屬建築裝飾	STORE 2	= STORE ROOM 2	= 儲物室 2
METAL A.F. ABOVE	= METAL ARCHITECTURAL FEATURE ABOVE	= 上方金屬建築裝飾	STOVE		= 煮食爐
METAL A.F. ABOVE AT TOP ROOF	= METAL ARCHITECTURAL FEATURE ABOVE AT TOP ROOF	= 天台上方金屬建築裝飾	T5A	= TOWER 5 (5A)	= 第 5 座 (5A)
METAL A.F. AT _/F	= METAL ARCHITECTURAL AT _/F	= 金屬建築裝飾於 _ 樓	T5B	= TOWER 5 (5B)	= 第 5 座 (5B)
METAL A.F. W/ ACCESS ON TOP	= METAL ARCHITECTURAL FEATURE WITH ACCESS ON TOP	= 金屬建築裝飾連頂部檢修蓋	TO TOWER 5 (5A)		= 往第 5 座 (5A)
METAL A.F. W/ ACCESS OPENING	= METAL ARCHITECTURAL FEATURE WITH ACCESS OPENING	= 金屬建築裝飾連檢修開口	TO TOWER 5 (5B)		= 往第 5 座 (5B)
M.L. AT H/L.	= METAL LOUVRE AT HIGH LEVEL	= 上方金屬百葉	T.R.S.	= TEMPORARY REFUGE SPACE	= 臨時庇護處
M.L. AT H/L. FOR STAIR VENT	= METAL LOUVRE AT HIGH LEVEL FOR STAIR VENT	= 上方樓梯通風金屬百葉	UP		= 上
M.L. BELOW	= METAL LOUVRE BELOW	= 下方金屬百葉	U.P.	= UTILITY PLATFORM	= 工作平台
M.L. W/. WIND GUARD	= METAL LOUVRE WITH WIND GUARD	= 金屬百葉連防風罩	U.P. ABOVE	= UTILITY PLATFORM ABOVE	= 上方工作平台
ON-GRADE PLANTER		= 地面花槽	TRANSFER PLATE		= 轉換層
OPEN KIT.	= OPEN KITCHEN	= 開放式廚房	TRANSFER PLATE LINE ABOVE		= 上方轉換層線
P.	= PLANTER	= 花槽			
PART PLAN AT _/F		= _ 樓部分平面圖			

TRANSFER PLATE LINE AT _ / F		= 轉換層線於 _ 樓
U.P. / A.C.P. ABOVE	= UTILITY PLATFORM / AIR CONDITIONER PLATFORM ABOVE	= 上方工作平台 / 冷氣機平台
UPPER PART OF RAINWATER HARVESTING WATER TANK & PUMP RM.	= UPPER PART OF RAINWATER HARVESTING WATER TANK & PUMP ROOM	= 雨水收集水箱連泵房上方
WALK-IN CLOSET		= 衣帽間
W.M.C.	= WATER METER CABINET	= 水錶櫃
 A/C UNIT	= AIR CONDITIONER UNIT	= 冷氣機
	= DESIGNATED COMMON AREA IN DEED OF MUTUAL COVENANT FOR MAINTENANCE	= 公契中用作保養的特定公用 地方
A.S.D.	= ACOUSTIC SLIDING DOOR	= 減音趟門
A.W.1./A.W.2	= ACOUSTIC WINDOW	= 減音窗戶
M.W.	= MAINTENANCE WINDOW	= 維修窗戶
S.A.M.	= SOUND ABSORPTIVE MATERIAL	= 吸音物料
S.C.D.	= SELF-CLOSING SWING DOOR	= 自動關閉掩門

Notes applicable to the floor plans of this section:

1. There may be architectural features and/or exposed pipes on external walls of some floors.
2. Common pipes exposed and/ or enclosed in cladding are located at/ adjacent to balcony and/ or flat roof and/ or roof and/ or utility platform and/ or air-conditioner platform and/ or external wall of some units.
3. There are ceiling bulkheads or false ceiling at living room, dining room, bedroom, bathroom, store room, open kitchen and kitchen of some units for the air-conditioning system and/or mechanical and electrical services. There are sunken slabs for mechanical & electrical services of units above at some residential units.
4. The internal ceiling height within some units may vary due to structural, architectural and/ or decoration design variations.
5. Symbols of fittings and fitments shown on the floor plans, such as doors, bath tubs, basins, water closets, basin cabinets, sinks etc, are retrieved from the latest approved building plans and only for general indication of their approximate location, but not indications of their actual size, design, shape and quantity.
6. For some residential units, the air-conditioner platform(s) outside the residential unit will be placed with 1 or more air-conditioner(s) (Outdoor Unit). These air-conditioner(s) may generate heat and/ or sound.
7. Balconies and utility platforms are non-enclosed areas.
8. During the necessary maintenance of the external walls by manager of the Phase, the gondola will be operating in the airspace outside window of residential properties and above flat roof and roof in such tower.

適用於本節各樓面平面圖之備註：

1. 部份樓層外牆設有建築裝飾及 / 或外露喉管。
2. 部份單位的露台及 / 或平台及 / 或天台及 / 或工作平台及 / 或空調機平台及 / 或外牆或其鄰近地方設有外露及 / 或內藏於飾板的公用喉管。
3. 部份單位客廳、飯廳、睡房、浴室、儲物室、開放式廚房及廚房有裝飾橫樑或假天花，用以裝置冷氣系統及 / 或機電設備。部分單位天花有跌級樓板，用以安裝樓上單位之機電設備。
4. 部份單位之天花高度將會因應結構、建築及 / 或裝修設計上的需要而有差異。
5. 樓面平面圖上所顯示的形象裝置符號，例如門、浴缸、洗面盆、坐廁、洗面盆櫃、洗滌盆等乃根據最新的經批准的建築圖則，只作一般性標誌以顯示其大約位置，而非展示其實際大小、設計、形狀及數量。
6. 部份住宅單位外的空調機平台將會放置一部或多部空調機(室外機)。該等空調機可能發出熱力及 / 或聲音。
7. 露台及工作平台為不可圍封的地方。
8. 在期數管理人員安排外牆之必要維修進行期間，吊船將在該等大廈的住宅物業之窗戶外及平台及天台上之空間運作。

TOWER 3  
第 3 座

3/F  
3 樓

FLOOR PLAN  
樓面平面圖



Scale 0 5M/米  
比例

Tower 座	Floor 樓層	Unit 單位	The thickness of the floor slabs (excluding plaster) of each residential property (mm) 每個住宅物業的樓板 (不包括灰泥) 的厚度 (毫米)	The floor-to-floor height of each residential property (mm) 每個住宅物業的層與層之間的高度 (毫米)
Tower 3 第3座	3/F 3樓	B	150, 175	2850, 3150
		C	150, 175	2800, 3150
		D	150, 175	2850, 3150
		E	150, 175	2850, 3150
		F	150, 175	2800, 2850, 3150
		G	150	2850, 3150
		H	150, 175	2800, 2850, 3150
		J	150	2850, 3150
		K	150	2850, 3150

The internal areas of the residential properties on the upper floors will generally be slightly larger than those on the lower floors because of the reducing thickness of the structural walls on the upper floors.

Notes:

1. The dimensions in the floor plan are all structural dimensions in millimeter.
2. Please refer to pages 23 to 25 of this sales brochure for legend of the terms and abbreviations and guidance notes in studying the floor plans of this section.

因住宅物業的較高樓層的結構牆的厚度遞減，較高樓層的內部面積，一般比較低樓層的內部面積稍大。

備註：

1. 平面圖所列之數字為以毫米標示之建築結構尺寸。
2. 請參閱本售樓說明書第 23 至 25 頁之圖例及指引以協助解讀此部分的平面圖及其顯示之名稱及簡稱。

TOWER 3  
第 3 座

5/F  
5 樓

FLOOR PLAN  
樓面平面圖



Scale 0 5M/米  
比例

Tower 座	Floor 樓層	Unit 單位	The thickness of the floor slabs (excluding plaster) of each residential property (mm) 每個住宅物業的樓板(不包括灰泥)的厚度(毫米)	The floor-to-floor height of each residential property (mm) 每個住宅物業的層與層之間的高度(毫米)
Tower 3 第3座	5/F 5樓	A	150, 175	2850, 3150
		B	150, 175	3150
		C	150, 175	3150
		D	150, 175	3150
		E	150, 175	3150
		F	150, 175	3150
		G	150	3150
		H	150, 175	3150
		J	150	3150
		K	150	3150
		M	150	2850, 3150
		N	150	2850, 3150

The internal areas of the residential properties on the upper floors will generally be slightly larger than those on the lower floors because of the reducing thickness of the structural walls on the upper floors.

Notes:

1. The dimensions in the floor plan are all structural dimensions in millimeter.
2. Please refer to pages 23 to 25 of this sales brochure for legend of the terms and abbreviations and guidance notes in studying the floor plans of this section.

因住宅物業的較高樓層的結構牆的厚度遞減，較高樓層的內部面積，一般比較低樓層的內部面積稍大。

備註：

1. 平面圖所列之數字為以毫米標示之建築結構尺寸。
2. 請參閱本售樓說明書第 23 至 25 頁之圖例及指引以協助解讀此部分的平面圖及其顯示之名稱及簡稱。

TOWER 3  
第3座

6/F - 12/F, 15/F - 23/F & 25/F - 26/F  
6樓至12樓、15樓至23樓及25樓至26樓

FLOOR PLAN  
樓面平面圖



Scale 0 5M/米  
比例



Tower 座	Floor 樓層	Unit 單位	The thickness of the floor slabs (excluding plaster) of each residential property (mm) 每個住宅物業的樓板 (不包括灰泥) 的厚度 (毫米)	The floor-to-floor height of each residential property (mm) 每個住宅物業的層與層之間的高度 (毫米)
Tower 3 第3座	6/F - 12/F, 15/F - 23/F & 25/F 6樓至12樓、 15樓至23樓及25樓	A	150, 175	3150
		B	150, 175	3150
		C	150, 175	3150
		D	150, 175	3150
		E	150, 175	3150
		F	150, 175	3150
		G	150	3150
		H	150, 175	3150
		J	150	3150
		K	150	3150
		M	150	3150
		N	150	3150
	26/F 26樓	A	150, 175	3500, 3800
		B	150, 175	3500, 3800
		C	150, 175	3500, 3800
		D	150, 175	3500, 3800
		E	150, 175	3500, 3800
		F	150, 175	3500, 3800, 3850
		G	150	3500, 3800
		H	150, 175	3500, 3800, 3850
		J	150	3500, 3800
		K	150	3500, 3800
M	150	3500, 3800		
N	150	3500, 3800		

The internal areas of the residential properties on the upper floors will generally be slightly larger than those on the lower floors because of the reducing thickness of the structural walls on the upper floors.

Notes:

- The dimensions in the floor plan are all structural dimensions in millimeter.
- Please refer to pages 23 to 25 of this sales brochure for legend of the terms and abbreviations and guidance notes in studying the floor plans of this section.

因住宅物業的較高樓層的結構牆的厚度遞減，較高樓層的內部面積，一般比較低樓層的內部面積稍大。

備註：

- 平面圖所列之數字為以毫米標示之建築結構尺寸。
- 請參閱本售樓說明書第23至25頁之圖例及指引以協助解讀此部分的平面圖及其顯示之名稱及簡稱。

TOWER 3  
第3座

Roof  
天台

FLOOR PLAN  
樓面平面圖



Scale 0 5M/米  
比例

Tower 座	Floor 樓層	Unit 單位	The thickness of the floor slabs (excluding plaster) of each residential property (mm) 每個住宅物業的樓板 (不包括灰泥) 的厚度 (毫米)	The floor-to-floor height of each residential property (mm) 每個住宅物業的層與層之間的高度 (毫米)
Tower 3 第3座	Roof 天台	A	Not Applicable 不適用	Not Applicable 不適用
		B		
		C		
		D		
		E		
		F		
		G		
		H		
		J		
		K		
		M		
		N		

The internal areas of the residential properties on the upper floors will generally be slightly larger than those on the lower floors because of the reducing thickness of the structural walls on the upper floors.

Notes:

1. The dimensions in the floor plan are all structural dimensions in millimeter.
2. Please refer to pages 23 to 25 of this sales brochure for legend of the terms and abbreviations and guidance notes in studying the floor plans of this section.

因住宅物業的較高樓層的結構牆的厚度遞減，較高樓層的內部面積，一般比較低樓層的內部面積稍大。

備註：

1. 平面圖所列之數字為以毫米標示之建築結構尺寸。
2. 請參閱本售樓說明書第 23 至 25 頁之圖例及指引以協助解讀此部分的平面圖及其顯示之名稱及簡稱。

TOWER 5 (5A)  
第5座(5A)

3/F  
3樓

FLOOR PLAN  
樓面平面圖



Scale 0 5M/米  
比例

Tower 座	Floor 樓層	Unit 單位	The thickness of the floor slabs (excluding plaster) of each residential property (mm) 每個住宅物業的樓板 (不包括灰泥) 的厚度 (毫米)	The floor-to-floor height of each residential property (mm) 每個住宅物業的層與層之間的高度 (毫米)
Tower 5 (5A) 第5座 (5A)	3/F 3樓	A	150	2850, 3150
		B	150, 175	2800, 3150
		C	150	2800, 2950, 3150
		D	150, 175	2800, 3150
		E	150	2850, 3150
		F	150, 175	2850, 3150
		G	150, 175	2850, 3150
		M	150, 175	2800, 3150
		N	150, 175	2800, 3150
		P	150	2800, 3150
		Q	150, 175	2800, 3150

The internal areas of the residential properties on the upper floors will generally be slightly larger than those on the lower floors because of the reducing thickness of the structural walls on the upper floors.

Notes:

1. The dimensions in the floor plan are all structural dimensions in millimeter.
2. Please refer to pages 23 to 25 of this sales brochure for legend of the terms and abbreviations and guidance notes in studying the floor plans of this section.

因住宅物業的較高樓層的結構牆的厚度遞減，較高樓層的內部面積，一般比較低樓層的內部面積稍大。

備註：

1. 平面圖所列之數字為以毫米標示之建築結構尺寸。
2. 請參閱本售樓說明書第 23 至 25 頁之圖例及指引以協助解讀此部分的平面圖及其顯示之名稱及簡稱。

TOWER 5 (5A)  
第5座(5A)

5/F  
5樓

FLOOR PLAN  
樓面平面圖



Scale 0 5M/米  
比例

Tower 座	Floor 樓層	Unit 單位	The thickness of the floor slabs (excluding plaster) of each residential property (mm) 每個住宅物業的樓板 (不包括灰泥) 的厚度 (毫米)	The floor-to-floor height of each residential property (mm) 每個住宅物業的層與層之間的高度 (毫米)
Tower 5 (5A) 第5座 (5A)	5/F 5樓	A	150	3150
		B	150, 175	3150
		C	150	3150
		D	150, 175	3150
		E	150	3150
		F	150, 175	3150
		G	150, 175	3150
		J	150	2850, 3150
		K	150, 175	2800, 3150
		M	150, 175	3150
		N	150, 175	3150
		P	150	3150
		Q	150, 175	3150
R	150, 175	2800, 3150		

The internal areas of the residential properties on the upper floors will generally be slightly larger than those on the lower floors because of the reducing thickness of the structural walls on the upper floors.

Notes:

1. The dimensions in the floor plan are all structural dimensions in millimeter.
2. Please refer to pages 23 to 25 of this sales brochure for legend of the terms and abbreviations and guidance notes in studying the floor plans of this section.

因住宅物業的較高樓層的結構牆的厚度遞減，較高樓層的內部面積，一般比較低樓層的內部面積稍大。

備註：

1. 平面圖所列之數字為以毫米標示之建築結構尺寸。
2. 請參閱本售樓說明書第 23 至 25 頁之圖例及指引以協助解讀此部分的平面圖及其顯示之名稱及簡稱。

TOWER 5 (5A)  
第5座(5A)

6/F  
6樓

FLOOR PLAN  
樓面平面圖



Scale 0 5M/米  
比例



Tower 座	Floor 樓層	Unit 單位	The thickness of the floor slabs (excluding plaster) of each residential property (mm) 每個住宅物業的樓板(不包括灰泥)的厚度(毫米)	The floor-to-floor height of each residential property (mm) 每個住宅物業的層與層之間的高度(毫米)
Tower 5 (5A) 第5座(5A)	6/F 6樓	A	150	3150
		B	150, 175	3150
		C	150	3150
		D	150, 175	3150
		E	150	3150
		F	150, 175	3150
		G	150, 175	3150
		H	150	3150
		J	150	3150
		K	150, 175	3150
		M	150, 175	3150
		N	150, 175	3150
		P	150	3150
		Q	150, 175	3150
R	150, 200	3150		

The internal areas of the residential properties on the upper floors will generally be slightly larger than those on the lower floors because of the reducing thickness of the structural walls on the upper floors.

Notes:

1. The dimensions in the floor plan are all structural dimensions in millimeter.
2. Please refer to pages 23 to 25 of this sales brochure for legend of the terms and abbreviations and guidance notes in studying the floor plans of this section.

因住宅物業的較高樓層的結構牆的厚度遞減，較高樓層的內部面積，一般比較低樓層的內部面積稍大。

備註：

1. 平面圖所列之數字為以毫米標示之建築結構尺寸。
2. 請參閱本售樓說明書第 23 至 25 頁之圖例及指引以協助解讀此部分的平面圖及其顯示之名稱及簡稱。



Tower 座	Floor 樓層	Unit 單位	The thickness of the floor slabs (excluding plaster) of each residential property (mm) 每個住宅物業的樓板 (不包括灰泥) 的厚度 (毫米)	The floor-to-floor height of each residential property (mm) 每個住宅物業的層與層之間的高度 (毫米)
Tower 5 (5A) 第5座 (5A)	7/F 7樓	A	150	3150
		B	150, 175	3150
		C	150	3150
		D	150, 175	3150
		E	150	3150
		F	150, 175	3150
		G	150, 175	3150
		H	150	3150
		J	150	3150
		K	150, 175	3150
		M	150, 175	3150
		N	150, 175	3150
		P	150	3150

The internal areas of the residential properties on the upper floors will generally be slightly larger than those on the lower floors because of the reducing thickness of the structural walls on the upper floors.

Notes:

1. The dimensions in the floor plan are all structural dimensions in millimeter.
2. Please refer to pages 23 to 25 of this sales brochure for legend of the terms and abbreviations and guidance notes in studying the floor plans of this section.

因住宅物業的較高樓層的結構牆的厚度遞減，較高樓層的內部面積，一般比較低樓層的內部面積稍大。

備註：

1. 平面圖所列之數字為以毫米標示之建築結構尺寸。
2. 請參閱本售樓說明書第 23 至 25 頁之圖例及指引以協助解讀此部分的平面圖及其顯示之名稱及簡稱。

TOWER 5 (5A)  
第5座(5A)

8/F  
8樓

FLOOR PLAN  
樓面平面圖



Scale 0 5M/米  
比例

Tower 座	Floor 樓層	Unit 單位	The thickness of the floor slabs (excluding plaster) of each residential property (mm) 每個住宅物業的樓板 (不包括灰泥) 的厚度 (毫米)	The floor-to-floor height of each residential property (mm) 每個住宅物業的層與層之間的高度 (毫米)
Tower 5 (5A) 第5座 (5A)	8/F 8樓	A	150	3150
		B	150, 175	3150
		C	150	3150
		D	150, 175	3150
		E	150	3150
		F	150, 175	3150
		G	150, 175	3150
		H	150	3150
		J	150	3150
		K	150, 175	3150
		M	150, 175	3150
		N	150, 175	3150
P	150	3150		

The internal areas of the residential properties on the upper floors will generally be slightly larger than those on the lower floors because of the reducing thickness of the structural walls on the upper floors.

Notes:

1. The dimensions in the floor plan are all structural dimensions in millimeter.
2. Please refer to pages 23 to 25 of this sales brochure for legend of the terms and abbreviations and guidance notes in studying the floor plans of this section.

因住宅物業的較高樓層的結構牆的厚度遞減，較高樓層的內部面積，一般比較低樓層的內部面積稍大。

備註：

1. 平面圖所列之數字為以毫米標示之建築結構尺寸。
2. 請參閱本售樓說明書第 23 至 25 頁之圖例及指引以協助解讀此部分的平面圖及其顯示之名稱及簡稱。

TOWER 5 (5A)  
第5座(5A)

9/F  
9樓

FLOOR PLAN  
樓面平面圖



Scale 0 5M/米  
比例

Tower 座	Floor 樓層	Unit 單位	The thickness of the floor slabs (excluding plaster) of each residential property (mm) 每個住宅物業的樓板 (不包括灰泥) 的厚度 (毫米)	The floor-to-floor height of each residential property (mm) 每個住宅物業的層與層之間的高度 (毫米)
Tower 5 (5A) 第5座 (5A)	9/F 9樓	A	150	3150
		B	150, 175	3150
		C	150	3150
		D	150, 175	3150
		E	150	3150
		F	150, 175	3150
		G	150, 175	3150
		H	150	3150
		J	150	3150
		K	150, 175	3150
		M	150, 175	3150
		N	150, 175	3150
		P	150	3150

The internal areas of the residential properties on the upper floors will generally be slightly larger than those on the lower floors because of the reducing thickness of the structural walls on the upper floors.

Notes:

1. The dimensions in the floor plan are all structural dimensions in millimeter.
2. Please refer to pages 23 to 25 of this sales brochure for legend of the terms and abbreviations and guidance notes in studying the floor plans of this section.

因住宅物業的較高樓層的結構牆的厚度遞減，較高樓層的內部面積，一般比較低樓層的內部面積稍大。

備註：

1. 平面圖所列之數字為以毫米標示之建築結構尺寸。
2. 請參閱本售樓說明書第 23 至 25 頁之圖例及指引以協助解讀此部分的平面圖及其顯示之名稱及簡稱。





Tower 座	Floor 樓層	Unit 單位	The thickness of the floor slabs (excluding plaster) of each residential property (mm) 每個住宅物業的樓板(不包括灰泥)的厚度(毫米)	The floor-to-floor height of each residential property (mm) 每個住宅物業的層與層之間的高度(毫米)
Tower 5 (5A) 第5座(5A)	10/F - 12/F, 15/F - 23/F & 25/F 10樓至12樓、 15樓至23樓及25樓	A	150	3150
		B	150, 175	3150
		C	150	3150
		D	150, 175	3150
		E	150	3150
		F	150, 175	3150
		G	150, 175	3150
		H	150	3150
		J	150	3150
		K	150, 175	3150
		M	150, 175	3150
		N	150, 175	3150
		P	150	3150
	26/F 26樓	A	150	3150, 3450
		B	150, 175	3150, 3500
		C	150	3150, 3350, 3450
		D	150, 175	3150, 3500
		E	150	3150, 3450
		F	150, 175	3150, 3450
		G	150, 175	3150, 3450
		H	150	3150, 3450
		J	150	3150, 3450
		K	150, 175	3150, 3500
M	150, 175	3150, 3500		
N	150, 175	3150, 3500		
P	150	3150, 3500		

The internal areas of the residential properties on the upper floors will generally be slightly larger than those on the lower floors because of the reducing thickness of the structural walls on the upper floors.

Notes:

- The dimensions in the floor plan are all structural dimensions in millimeter.
- Please refer to pages 23 to 25 of this sales brochure for legend of the terms and abbreviations and guidance notes in studying the floor plans of this section.

因住宅物業的較高樓層的結構牆的厚度遞減，較高樓層的內部面積，一般比較低樓層的內部面積稍大。

備註：

- 平面圖所列之數字為以毫米標示之建築結構尺寸。
- 請參閱本售樓說明書第23至25頁之圖例及指引以協助解讀此部分的平面圖及其顯示之名稱及簡稱。

TOWER 5 (5A)  
第5座(5A)

Roof  
天台

FLOOR PLAN  
樓面平面圖

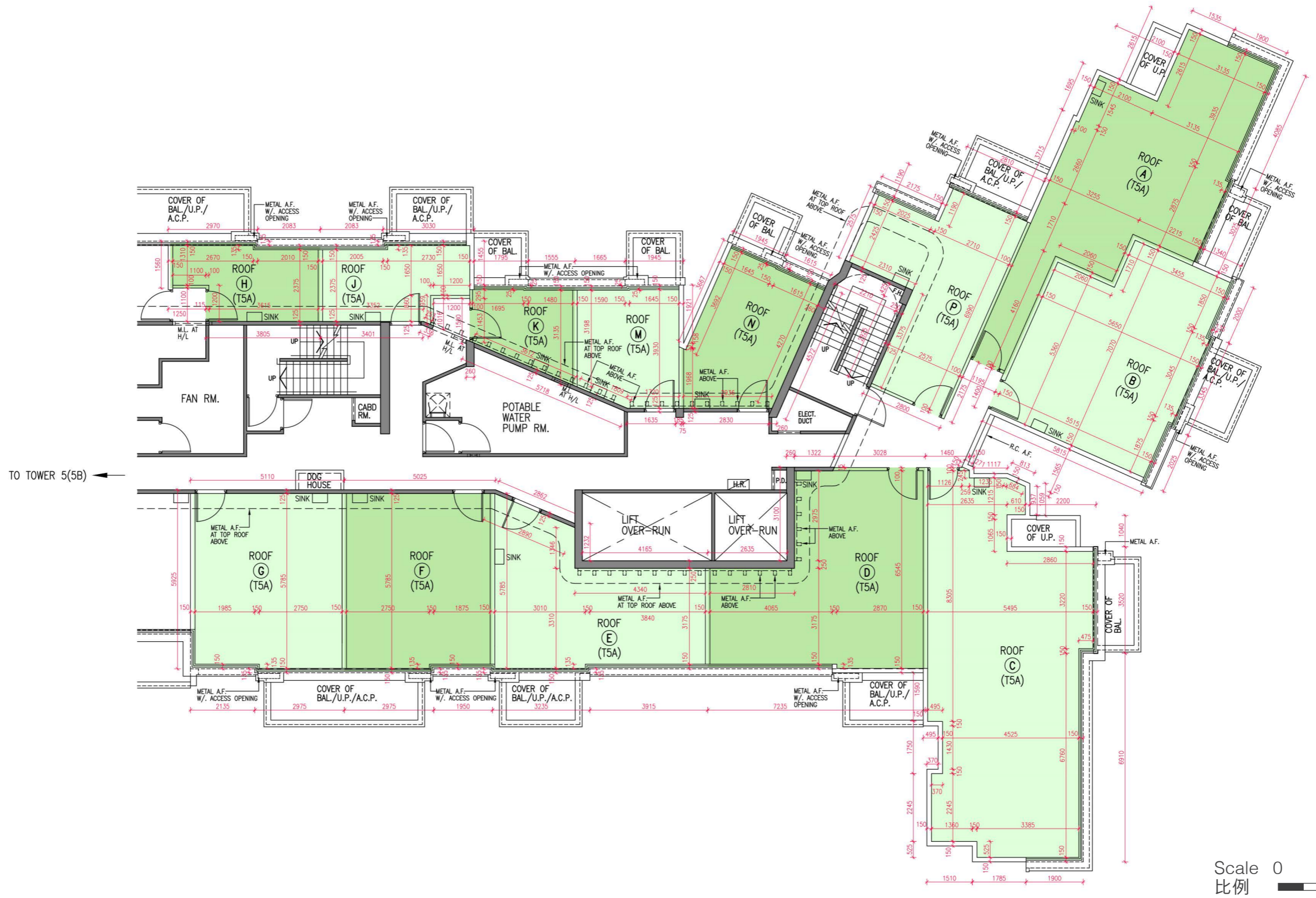

Scale 0 5M/米  
比例

Tower 座	Floor 樓層	Unit 單位	The thickness of the floor slabs (excluding plaster) of each residential property (mm) 每個住宅物業的樓板 (不包括灰泥) 的厚度 (毫米)	The floor-to-floor height of each residential property (mm) 每個住宅物業的層與層之間的高度 (毫米)
Tower 5 (5A) 第5座 (5A)	Roof 天台	A	Not Applicable 不適用	Not Applicable 不適用
		B		
		C		
		D		
		E		
		F		
		G		
		H		
		J		
		K		
		M		
		N		
		P		

The internal areas of the residential properties on the upper floors will generally be slightly larger than those on the lower floors because of the reducing thickness of the structural walls on the upper floors.

Notes:

1. The dimensions in the floor plan are all structural dimensions in millimeter.
2. Please refer to pages 23 to 25 of this sales brochure for legend of the terms and abbreviations and guidance notes in studying the floor plans of this section.

因住宅物業的較高樓層的結構牆的厚度遞減，較高樓層的內部面積，一般比較低樓層的內部面積稍大。

備註：

1. 平面圖所列之數字為以毫米標示之建築結構尺寸。
2. 請參閱本售樓說明書第 23 至 25 頁之圖例及指引以協助解讀此部分的平面圖及其顯示之名稱及簡稱。

TOWER 5 (5B)  
第5座(5B)

7/F  
7樓

FLOOR PLAN  
樓面平面圖



Scale 0 5M/米  
比例

Tower 座	Floor 樓層	Unit 單位	The thickness of the floor slabs (excluding plaster) of each residential property (mm) 每個住宅物業的樓板 (不包括灰泥) 的厚度 (毫米)	The floor-to-floor height of each residential property (mm) 每個住宅物業的層與層之間的高度 (毫米)
Tower 5 (5B) 第5座 (5B)	7/F 7樓	A	150, 175	3150
		B	150, 200	3150
		C	150, 175	3150
		J	150	3150
		K	150	3150
		M	150	3150
		N	150	3150

The internal areas of the residential properties on the upper floors will generally be slightly larger than those on the lower floors because of the reducing thickness of the structural walls on the upper floors.

Notes:

1. The dimensions in the floor plan are all structural dimensions in millimeter.
2. Please refer to pages 23 to 25 of this sales brochure for legend of the terms and abbreviations and guidance notes in studying the floor plans of this section.

因住宅物業的較高樓層的結構牆的厚度遞減，較高樓層的內部面積，一般比較低樓層的內部面積稍大。

備註：

1. 平面圖所列之數字為以毫米標示之建築結構尺寸。
2. 請參閱本售樓說明書第 23 至 25 頁之圖例及指引以協助解讀此部分的平面圖及其顯示之名稱及簡稱。

TOWER 5 (5B)  
第5座(5B)

8/F  
8樓

FLOOR PLAN  
樓面平面圖



Scale 0 5M/米  
比例

Tower 座	Floor 樓層	Unit 單位	The thickness of the floor slabs (excluding plaster) of each residential property (mm) 每個住宅物業的樓板 (不包括灰泥) 的厚度 (毫米)	The floor-to-floor height of each residential property (mm) 每個住宅物業的層與層之間的高度 (毫米)
Tower 5 (5B) 第5座 (5B)	8/F 8樓	A	150, 175	3150
		B	150, 200	3150
		C	150, 175	3150
		J	150	3150
		K	150	3150
		M	150	3150
		N	150	3150

The internal areas of the residential properties on the upper floors will generally be slightly larger than those on the lower floors because of the reducing thickness of the structural walls on the upper floors.

Notes:

1. The dimensions in the floor plan are all structural dimensions in millimeter.
2. Please refer to pages 23 to 25 of this sales brochure for legend of the terms and abbreviations and guidance notes in studying the floor plans of this section.

因住宅物業的較高樓層的結構牆的厚度遞減，較高樓層的內部面積，一般比較低樓層的內部面積稍大。

備註：

1. 平面圖所列之數字為以毫米標示之建築結構尺寸。
2. 請參閱本售樓說明書第 23 至 25 頁之圖例及指引以協助解讀此部分的平面圖及其顯示之名稱及簡稱。

TOWER 5 (5B)  
第5座(5B)

9/F  
9樓

FLOOR PLAN  
樓面平面圖



Scale 0 5M/米  
比例



Tower 座	Floor 樓層	Unit 單位	The thickness of the floor slabs (excluding plaster) of each residential property (mm) 每個住宅物業的樓板 (不包括灰泥) 的厚度 (毫米)	The floor-to-floor height of each residential property (mm) 每個住宅物業的層與層之間的高度 (毫米)
Tower 5 (5B) 第5座(5B)	9/F 9樓	A	150, 175	3150
		B	150, 200	3150
		C	150, 175	3150
		D	150, 175	2800, 3150
		E	150, 175	2800, 3150
		F	150	2850, 3150
		G	150	2850, 3150
		H	150	2850, 3150
		J	150	3150
		K	150	3150
		M	150	3150
		N	150	3150

The internal areas of the residential properties on the upper floors will generally be slightly larger than those on the lower floors because of the reducing thickness of the structural walls on the upper floors.

Notes:

1. The dimensions in the floor plan are all structural dimensions in millimeter.
2. Please refer to pages 23 to 25 of this sales brochure for legend of the terms and abbreviations and guidance notes in studying the floor plans of this section.

因住宅物業的較高樓層的結構牆的厚度遞減，較高樓層的內部面積，一般比較低樓層的內部面積稍大。

備註：

1. 平面圖所列之數字為以毫米標示之建築結構尺寸。
2. 請參閱本售樓說明書第 23 至 25 頁之圖例及指引以協助解讀此部分的平面圖及其顯示之名稱及簡稱。

TOWER 5 (5B)  
第5座(5B)

10/F - 12/F, 15/F - 23/F & 25/F - 26/F  
10樓至12樓、15樓至23樓及25樓至26樓

FLOOR PLAN  
樓面平面圖

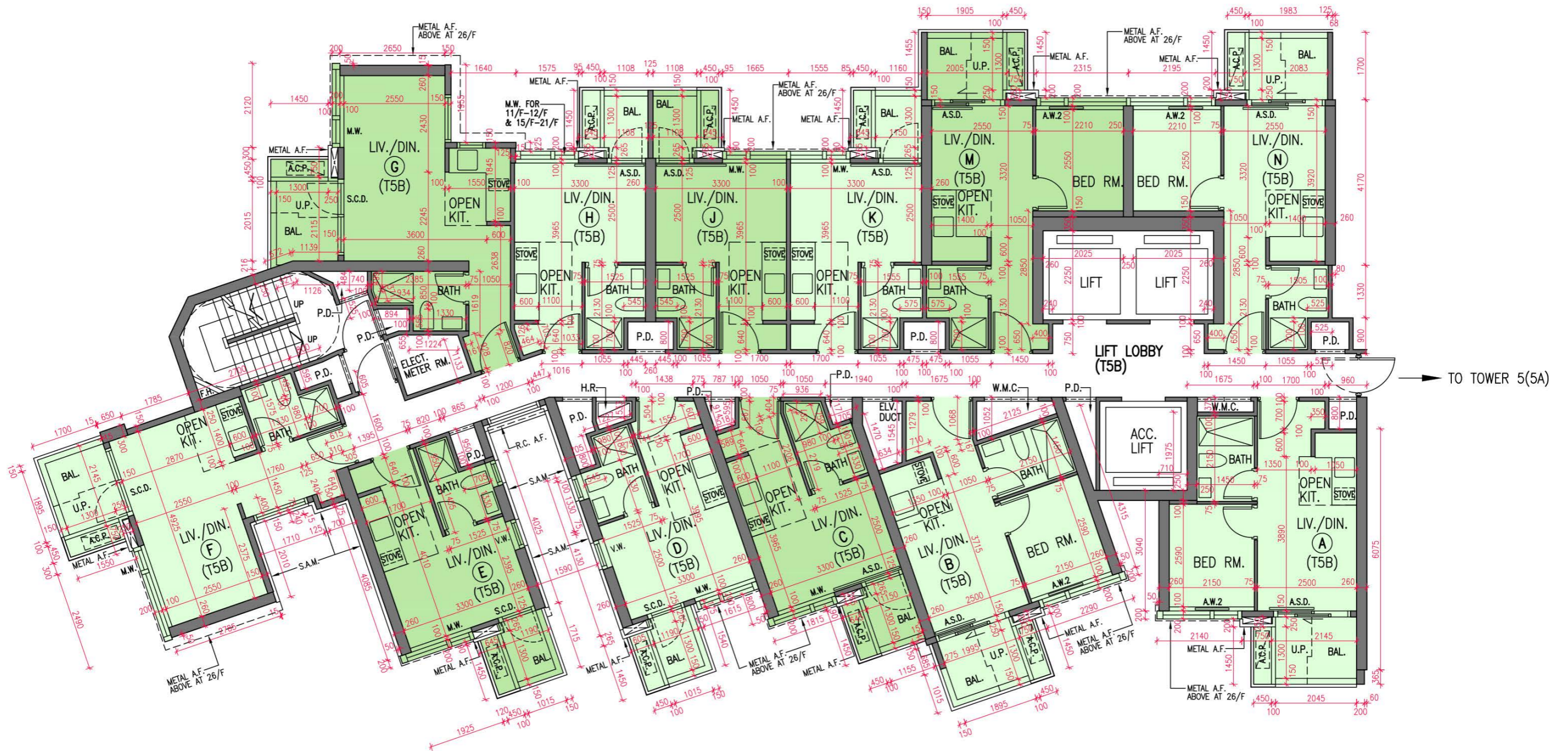

Scale 0 5M/米  
比例

Tower 座	Floor 樓層	Unit 單位	The thickness of the floor slabs (excluding plaster) of each residential property (mm) 每個住宅物業的樓板 (不包括灰泥) 的厚度 (毫米)	The floor-to-floor height of each residential property (mm) 每個住宅物業的層與層之間的高度 (毫米)
Tower 5 (5B) 第5座(5B)	10/F - 12/F, 15/F - 23/F & 25/F 10樓至12樓、 15樓至23樓及25樓	A	150, 175	3150
		B	150, 200	3150
		C	150, 175	3150
		D	150, 175	3150
		E	150, 175	3150
		F	150	3150
		G	150	3150
		H	150	3150
		J	150	3150
		K	150	3150
		M	150	3150
N	150	3150		
Tower 5 (5B) 第5座(5B)	26/F 26樓	A	150, 175	3150, 3500
		B	150, 200	3150, 3500
		C	150, 175	3150, 3500
		D	150, 175	3150, 3500
		E	150, 175	3150, 3500
		F	150	3150, 3450
		G	150	3150, 3450
		H	150	3150, 3450
		J	150	3150, 3450
		K	150	3150, 3450
		M	150	3150, 3450
N	150	3150, 3450		

The internal areas of the residential properties on the upper floors will generally be slightly larger than those on the lower floors because of the reducing thickness of the structural walls on the upper floors.

Notes:

1. The dimensions in the floor plan are all structural dimensions in millimeter.
2. Please refer to pages 23 to 25 of this sales brochure for legend of the terms and abbreviations and guidance notes in studying the floor plans of this section.

因住宅物業的較高樓層的結構牆的厚度遞減，較高樓層的內部面積，一般比較低樓層的內部面積稍大。

備註：

1. 平面圖所列之數字為以毫米標示之建築結構尺寸。
2. 請參閱本售樓說明書第 23 至 25 頁之圖例及指引以協助解讀此部分的平面圖及其顯示之名稱及簡稱。

TOWER 5 (5B)  
第5座(5B)

Roof  
天台

FLOOR PLAN  
樓面平面圖



Tower 座	Floor 樓層	Unit 單位	The thickness of the floor slabs (excluding plaster) of each residential property (mm) 每個住宅物業的樓板 (不包括灰泥) 的厚度 (毫米)	The floor-to-floor height of each residential property (mm) 每個住宅物業的層與層之間的高度 (毫米)
Tower 5 (5B) 第5座 (5B)	Roof 天台	A	Not Applicable 不適用	Not Applicable 不適用
		B		
		C		
		D		
		E		
		F		
		G		
		H		
		M		
		N		

The internal areas of the residential properties on the upper floors will generally be slightly larger than those on the lower floors because of the reducing thickness of the structural walls on the upper floors.

Notes:

1. The dimensions in the floor plan are all structural dimensions in millimeter.
2. Please refer to pages 23 to 25 of this sales brochure for legend of the terms and abbreviations and guidance notes in studying the floor plans of this section.

因住宅物業的較高樓層的結構牆的厚度遞減，較高樓層的內部面積，一般比較低樓層的內部面積稍大。

備註：

1. 平面圖所列之數字為以毫米標示之建築結構尺寸。
2. 請參閱本售樓說明書第 23 至 25 頁之圖例及指引以協助解讀此部分的平面圖及其顯示之名稱及簡稱。

Description of Residential Property 物業的描述			Saleable Area (including balcony, utility platform and verandah, if any) sq. metre (sq.ft.) 實用面積(包括露台, 工作平台及陽台(如有))平方米(平方呎)	Area of other specified items (Not included in the Saleable Area) sq. metre (sq.ft.) 其他指明項目的面積(不計算入實用面積)平方米(平方呎)									
Tower Name 大廈名稱	Floor 樓層	Unit 單位		Air-conditioning plant room 空調機房	Bay window 窗台	Cockloft 閣樓	Flat roof 平台	Garden 花園	Parking space 停車位	Roof 天台	Stairhood 梯屋	Terrace 前庭	Yard 庭院
Tower 3 第3座	3/F 3樓	B	38.851 ( 418 ) Balcony 露台 : - Utility Platform 工作平台 : -	-	-	-	14.868 ( 160 )	-	-	-	-	-	-
		C	35.618 ( 383 ) Balcony 露台 : - Utility Platform 工作平台 : -	-	-	-	16.099 ( 173 )	-	-	-	-	-	-
		D	38.041 ( 409 ) Balcony 露台 : - Utility Platform 工作平台 : -	-	-	-	17.494 ( 188 )	-	-	-	-	-	-
		E	34.707 ( 374 ) Balcony 露台 : - Utility Platform 工作平台 : -	-	-	-	13.820 ( 149 )	-	-	-	-	-	-
		F	33.855 ( 364 ) Balcony 露台 : - Utility Platform 工作平台 : -	-	-	-	13.984 ( 151 )	-	-	-	-	-	-
		G	39.550 ( 426 ) Balcony 露台 : - Utility Platform 工作平台 : -	-	-	-	25.046 ( 270 )	10.640 ( 115 )	-	-	-	-	-
		H	25.481 ( 274 ) Balcony 露台 : - Utility Platform 工作平台 : -	-	-	-	23.633 ( 254 )	-	-	-	-	-	-
		J	24.901 ( 268 ) Balcony 露台 : - Utility Platform 工作平台 : -	-	-	-	21.347 ( 230 )	-	-	-	-	-	-
		K	24.901 ( 268 ) Balcony 露台 : - Utility Platform 工作平台 : -	-	-	-	20.808 ( 224 )	-	-	-	-	-	-

The saleable area of each residential property and the floor areas of balcony, utility platform and verandah (if any) to the extent that it forms part of the residential property are calculated in accordance with section 8 of the Residential Properties (First-hand Sales) Ordinance; and the areas of other specified items (if any) to the extent that they form part of the residential property (not included in the saleable area) are calculated in accordance with Part 2 of Schedule 2 of the Residential Properties (First-hand Sales) Ordinance.

## Notes:

1. The above areas have been converted to square feet based on a conversion rate of 1 square metre=10.764 square feet and rounded off to the nearest integer and may be slightly different from that shown in square metre.
2. There is no verandah in the residential properties in the Phase.
3. 4/F, 13/F, 14/F, 24/F for all Towers are omitted.

每個住宅物業的實用面積、以及構成住宅物業的一部份的範圍內的露台、工作平台及陽台(如有)之樓面面積,是按照《一手住宅物業銷售條例》第8條計算得出的。在構成住宅物業的一部份的其他指明項目(如有)的面積(不計算入實用面積),是按照《一手住宅物業銷售條例》附表2第2部計算得出的。

## 備註:

1. 上述所列之面積以1平方米=10.764平方呎換算至平方呎,並四捨五入至整數。平方呎與平方米之數字可能有些微差異。
2. 期數住宅物業並無陽台。
3. 所有座數不設4樓、13樓、14樓及24樓。

Description of Residential Property 物業的描述			Saleable Area (including balcony, utility platform and verandah, if any) sq. metre (sq.ft.) 實用面積 (包括露台, 工作平台及陽台 (如有)) 平方米 (平方呎)	Area of other specified items (Not included in the Saleable Area) sq. metre (sq.ft.) 其他指明項目的面積 (不計算入實用面積) 平方米 (平方呎)									
Tower Name 大廈名稱	Floor 樓層	Unit 單位		Air-conditioning plant room 空調機房	Bay window 窗台	Cockloft 閣樓	Flat roof 平台	Garden 花園	Parking space 停車位	Roof 天台	Stairhood 梯屋	Terrace 前庭	Yard 庭院
Tower 3 第3座	5/F 5樓	A	55.542 ( 598 ) Balcony 露台: - Utility Platform 工作平台: -	-	-	-	33.659 ( 362 )	16.758 ( 180 )	-	-	-	-	-
		B	41.745 ( 449 ) Balcony 露台: 2.002 ( 22 ) Utility Platform 工作平台: 1.500 ( 16 )	-	-	-	-	-	-	-	-	-	-
		C	39.120 ( 421 ) Balcony 露台: 2.002 ( 22 ) Utility Platform 工作平台: 1.500 ( 16 )	-	-	-	-	-	-	-	-	-	-
		D	41.543 ( 447 ) Balcony 露台: 2.002 ( 22 ) Utility Platform 工作平台: 1.500 ( 16 )	-	-	-	-	-	-	-	-	-	-
		E	38.209 ( 411 ) Balcony 露台: 2.002 ( 22 ) Utility Platform 工作平台: 1.500 ( 16 )	-	-	-	-	-	-	-	-	-	-
		F	37.102 ( 399 ) Balcony 露台: 2.002 ( 22 ) Utility Platform 工作平台: 1.500 ( 16 )	-	-	-	-	-	-	-	-	-	-
		G	43.307 ( 466 ) Balcony 露台: 2.257 ( 24 ) Utility Platform 工作平台: 1.500 ( 16 )	-	-	-	-	-	-	-	-	-	-
		H	28.960 ( 312 ) Balcony 露台: 2.002 ( 22 ) Utility Platform 工作平台: 1.500 ( 16 )	-	-	-	-	-	-	-	-	-	-
		J	28.403 ( 306 ) Balcony 露台: 2.002 ( 22 ) Utility Platform 工作平台: 1.500 ( 16 )	-	-	-	-	-	-	-	-	-	-
		K	28.403 ( 306 ) Balcony 露台: 2.002 ( 22 ) Utility Platform 工作平台: 1.500 ( 16 )	-	-	-	-	-	-	-	-	-	-
		M	28.403 ( 306 ) Balcony 露台: 2.002 ( 22 ) Utility Platform 工作平台: 1.500 ( 16 )	-	-	-	4.407 ( 47 )	-	-	-	-	-	-
N	28.563 ( 307 ) Balcony 露台: 2.002 ( 22 ) Utility Platform 工作平台: 1.500 ( 16 )	-	-	-	22.785 ( 245 )	-	-	-	-	-	-		

The saleable area of each residential property and the floor areas of balcony, utility platform and verandah (if any) to the extent that it forms part of the residential property are calculated in accordance with section 8 of the Residential Properties (First-hand Sales) Ordinance; and the areas of other specified items (if any) to the extent that they form part of the residential property (not included in the saleable area) are calculated in accordance with Part 2 of Schedule 2 of the Residential Properties (First-hand Sales) Ordinance.

## Notes:

- The above areas have been converted to square feet based on a conversion rate of 1 square metre=10.764 square feet and rounded off to the nearest integer and may be slightly different from that shown in square metre.
- There is no verandah in the residential properties in the Phase.
- 4/F, 13/F, 14/F, 24/F for all Towers are omitted.

每個住宅物業的實用面積、以及構成住宅物業的一部份的範圍內的露台、工作平台及陽台 (如有) 之樓面面積, 是按照《一手住宅物業銷售條例》第8條計算得出的。在構成住宅物業的一部份的其他指明項目 (如有) 的面積 (不計算入實用面積), 是按照《一手住宅物業銷售條例》附表2第2部計算得出的。

## 備註:

- 上述所列之面積以1平方米 = 10.764平方呎換算至平方呎, 並四捨五入至整數。平方呎與平方米之數字可能有些微差異。
- 期數住宅物業並無陽台。
- 所有座數不設4樓、13樓、14樓及24樓。

Description of Residential Property 物業的描述			Saleable Area (including balcony, utility platform and verandah, if any) sq. metre (sq.ft.) 實用面積 (包括露台, 工作平台及陽台 (如有)) 平方米 (平方呎)	Area of other specified items (Not included in the Saleable Area) sq. metre (sq.ft.) 其他指明項目的面積 (不計算入實用面積) 平方米 (平方呎)										
Tower Name 大廈名稱	Floor 樓層	Unit 單位		Air-conditioning plant room 空調機房	Bay window 窗台	Cockloft 閣樓	Flat roof 平台	Garden 花園	Parking space 停車位	Roof 天台	Stairhood 梯屋	Terrace 前庭	Yard 庭院	
Tower 3 第3座	6/F - 12/F, 15/F - 23/F & 25/F 6樓至 12樓、 15樓至 23樓及 25樓	A	60.683 ( 653 ) Balcony 露台: 3.633 ( 39 ) Utility Platform 工作平台: 1.508 ( 16 )	-	-	-	-	-	-	-	-	-	-	
		B	41.655 ( 448 ) Balcony 露台: 2.002 ( 22 ) Utility Platform 工作平台: 1.500 ( 16 )	-	-	-	-	-	-	-	-	-	-	-
		C	39.120 ( 421 ) Balcony 露台: 2.002 ( 22 ) Utility Platform 工作平台: 1.500 ( 16 )	-	-	-	-	-	-	-	-	-	-	-
		D	41.543 ( 447 ) Balcony 露台: 2.002 ( 22 ) Utility Platform 工作平台: 1.500 ( 16 )	-	-	-	-	-	-	-	-	-	-	-
		E	38.209 ( 411 ) Balcony 露台: 2.002 ( 22 ) Utility Platform 工作平台: 1.500 ( 16 )	-	-	-	-	-	-	-	-	-	-	-
		F	37.102 ( 399 ) Balcony 露台: 2.002 ( 22 ) Utility Platform 工作平台: 1.500 ( 16 )	-	-	-	-	-	-	-	-	-	-	-
		G	43.307 ( 466 ) Balcony 露台: 2.257 ( 24 ) Utility Platform 工作平台: 1.500 ( 16 )	-	-	-	-	-	-	-	-	-	-	-
		H	28.960 ( 312 ) Balcony 露台: 2.002 ( 22 ) Utility Platform 工作平台: 1.500 ( 16 )	-	-	-	-	-	-	-	-	-	-	-
		J	28.403 ( 306 ) Balcony 露台: 2.002 ( 22 ) Utility Platform 工作平台: 1.500 ( 16 )	-	-	-	-	-	-	-	-	-	-	-
		K	28.403 ( 306 ) Balcony 露台: 2.002 ( 22 ) Utility Platform 工作平台: 1.500 ( 16 )	-	-	-	-	-	-	-	-	-	-	-
		M	28.403 ( 306 ) Balcony 露台: 2.002 ( 22 ) Utility Platform 工作平台: 1.500 ( 16 )	-	-	-	-	-	-	-	-	-	-	-
N	28.563 ( 307 ) Balcony 露台: 2.002 ( 22 ) Utility Platform 工作平台: 1.500 ( 16 )	-	-	-	-	-	-	-	-	-	-	-		

The saleable area of each residential property and the floor areas of balcony, utility platform and verandah (if any) to the extent that it forms part of the residential property are calculated in accordance with section 8 of the Residential Properties (First-hand Sales) Ordinance; and the areas of other specified items (if any) to the extent that they form part of the residential property (not included in the saleable area) are calculated in accordance with Part 2 of Schedule 2 of the Residential Properties (First-hand Sales) Ordinance.

## Notes:

- The above areas have been converted to square feet based on a conversion rate of 1 square metre=10.764 square feet and rounded off to the nearest integer and may be slightly different from that shown in square metre.
- There is no verandah in the residential properties in the Phase.
- 4/F, 13/F, 14/F, 24/F for all Towers are omitted.

每個住宅物業的實用面積、以及構成住宅物業的一部份的範圍內的露台、工作平台及陽台 (如有) 之樓面面積, 是按照《一手住宅物業銷售條例》第8條計算得出的。在構成住宅物業的一部份的其他指明項目 (如有) 的面積 (不計算入實用面積), 是按照《一手住宅物業銷售條例》附表2第2部計算得出的。

## 備註:

- 上述所列之面積以1平方米 = 10.764平方呎換算至平方呎, 並四捨五入至整數。平方呎與平方米之數字可能有些微差異。
- 期數住宅物業並無陽台。
- 所有座數不設4樓、13樓、14樓及24樓。



Description of Residential Property 物業的描述			Saleable Area (including balcony, utility platform and verandah, if any) sq. metre (sq.ft.) 實用面積 (包括露台, 工作平台及陽台 (如有)) 平方米 (平方呎)	Area of other specified items (Not included in the Saleable Area) sq. metre (sq.ft.) 其他指明項目的面積 (不計算入實用面積) 平方米 (平方呎)									
Tower Name 大廈名稱	Floor 樓層	Unit 單位		Air-conditioning plant room 空調機房	Bay window 窗台	Cockloft 閣樓	Flat roof 平台	Garden 花園	Parking space 停車位	Roof 天台	Stairhood 梯屋	Terrace 前庭	Yard 庭院
Tower 3 第3座	26/F 26樓	A	60.683 ( 653 ) Balcony 露台: 3.633 ( 39 ) Utility Platform 工作平台: 1.508 ( 16 )	-	-	-	-	-	-	51.082 ( 550 )	-	-	-
		B	41.655 ( 448 ) Balcony 露台: 2.002 ( 22 ) Utility Platform 工作平台: 1.500 ( 16 )	-	-	-	-	-	-	39.925 ( 430 )	-	-	-
		C	39.120 ( 421 ) Balcony 露台: 2.002 ( 22 ) Utility Platform 工作平台: 1.500 ( 16 )	-	-	-	-	-	-	32.665 ( 352 )	-	-	-
		D	41.543 ( 447 ) Balcony 露台: 2.002 ( 22 ) Utility Platform 工作平台: 1.500 ( 16 )	-	-	-	-	-	-	22.638 ( 244 )	-	-	-
		E	38.209 ( 411 ) Balcony 露台: 2.002 ( 22 ) Utility Platform 工作平台: 1.500 ( 16 )	-	-	-	-	-	-	36.006 ( 388 )	-	-	-
		F	37.102 ( 399 ) Balcony 露台: 2.002 ( 22 ) Utility Platform 工作平台: 1.500 ( 16 )	-	-	-	-	-	-	36.387 ( 392 )	-	-	-
		G	43.307 ( 466 ) Balcony 露台: 2.257 ( 24 ) Utility Platform 工作平台: 1.500 ( 16 )	-	-	-	-	-	-	31.926 ( 344 )	-	-	-
		H	28.960 ( 312 ) Balcony 露台: 2.002 ( 22 ) Utility Platform 工作平台: 1.500 ( 16 )	-	-	-	-	-	-	21.816 ( 235 )	-	-	-
		J	28.403 ( 306 ) Balcony 露台: 2.002 ( 22 ) Utility Platform 工作平台: 1.500 ( 16 )	-	-	-	-	-	-	21.156 ( 228 )	-	-	-
		K	28.403 ( 306 ) Balcony 露台: 2.002 ( 22 ) Utility Platform 工作平台: 1.500 ( 16 )	-	-	-	-	-	-	21.156 ( 228 )	-	-	-
		M	28.403 ( 306 ) Balcony 露台: 2.002 ( 22 ) Utility Platform 工作平台: 1.500 ( 16 )	-	-	-	-	-	-	21.156 ( 228 )	-	-	-
N	28.563 ( 307 ) Balcony 露台: 2.002 ( 22 ) Utility Platform 工作平台: 1.500 ( 16 )	-	-	-	-	-	-	20.939 ( 225 )	-	-	-		

The saleable area of each residential property and the floor areas of balcony, utility platform and verandah (if any) to the extent that it forms part of the residential property are calculated in accordance with section 8 of the Residential Properties (First-hand Sales) Ordinance; and the areas of other specified items (if any) to the extent that they form part of the residential property (not included in the saleable area) are calculated in accordance with Part 2 of Schedule 2 of the Residential Properties (First-hand Sales) Ordinance.

## Notes:

- The above areas have been converted to square feet based on a conversion rate of 1 square metre=10.764 square feet and rounded off to the nearest integer and may be slightly different from that shown in square metre.
- There is no verandah in the residential properties in the Phase.
- 4/F, 13/F, 14/F, 24/F for all Towers are omitted.

每個住宅物業的實用面積、以及構成住宅物業的一部份的範圍內的露台、工作平台及陽台 (如有) 之樓面面積, 是按照《一手住宅物業銷售條例》第8條計算得出的。在構成住宅物業的一部份的其他指明項目 (如有) 的面積 (不計算入實用面積), 是按照《一手住宅物業銷售條例》附表2第2部計算得出的。

## 備註:

- 上述所列之面積以1平方米 = 10.764平方呎換算至平方呎, 並四捨五入至整數。平方呎與平方米之數字可能有些微差異。
- 期數住宅物業並無陽台。
- 所有座數不設4樓、13樓、14樓及24樓。

Description of Residential Property 物業的描述			Saleable Area (including balcony, utility platform and verandah, if any) sq. metre (sq.ft.) 實用面積 (包括露台, 工作平台及陽台 (如有)) 平方米 (平方呎)	Area of other specified items (Not included in the Saleable Area) sq. metre (sq.ft.) 其他指明項目的面積 (不計算入實用面積) 平方米 (平方呎)									
Tower Name 大廈名稱	Floor 樓層	Unit 單位		Air-conditioning plant room 空調機房	Bay window 窗台	Cockloft 閣樓	Flat roof 平台	Garden 花園	Parking space 停車位	Roof 天台	Stairhood 梯屋	Terrace 前庭	Yard 庭院
Tower 5 (5A) 第5座 (5A)	3/F 3樓	A	42.993 ( 463 ) Balcony 露台 : - Utility Platform 工作平台 : -	-	-	-	21.122 ( 227 )	-	-	-	-	-	-
		B	37.892 ( 408 ) Balcony 露台 : - Utility Platform 工作平台 : -	-	-	-	5.881 ( 63 )	3.491 ( 38 )	-	-	-	-	-
		C	65.971 ( 710 ) Balcony 露台 : - Utility Platform 工作平台 : -	-	-	-	17.466 ( 188 )	10.791 ( 116 )	-	-	-	-	-
		D	37.562 ( 404 ) Balcony 露台 : - Utility Platform 工作平台 : -	-	-	-	12.647 ( 136 )	-	-	-	-	-	-
		E	37.295 ( 401 ) Balcony 露台 : - Utility Platform 工作平台 : -	-	-	-	13.679 ( 147 )	-	-	-	-	-	-
		F	29.001 ( 312 ) Balcony 露台 : - Utility Platform 工作平台 : -	-	-	-	7.892 ( 85 )	-	-	-	-	-	-
		G	29.654 ( 319 ) Balcony 露台 : - Utility Platform 工作平台 : -	-	-	-	8.240 ( 89 )	-	-	-	-	-	-
		M	17.600 ( 189 ) Balcony 露台 : - Utility Platform 工作平台 : -	-	-	-	16.347 ( 176 )	-	-	-	-	-	-
		N	19.960 ( 215 ) Balcony 露台 : - Utility Platform 工作平台 : -	-	-	-	13.743 ( 148 )	-	-	-	-	-	-
		P	25.704 ( 277 ) Balcony 露台 : - Utility Platform 工作平台 : -	-	-	-	16.788 ( 181 )	-	-	-	-	-	-
Q	25.540 ( 275 ) Balcony 露台 : - Utility Platform 工作平台 : -	-	-	-	14.375 ( 155 )	-	-	-	-	-	-		

The saleable area of each residential property and the floor areas of balcony, utility platform and verandah (if any) to the extent that it forms part of the residential property are calculated in accordance with section 8 of the Residential Properties (First-hand Sales) Ordinance; and the areas of other specified items (if any) to the extent that they form part of the residential property (not included in the saleable area) are calculated in accordance with Part 2 of Schedule 2 of the Residential Properties (First-hand Sales) Ordinance.

## Notes:

- The above areas have been converted to square feet based on a conversion rate of 1 square metre=10.764 square feet and rounded off to the nearest integer and may be slightly different from that shown in square metre.
- There is no verandah in the residential properties in the Phase.
- 4/F, 13/F, 14/F, 24/F for all Towers are omitted.

每個住宅物業的實用面積、以及構成住宅物業的一部份的範圍內的露台、工作平台及陽台 (如有) 之樓面面積, 是按照《一手住宅物業銷售條例》第8條計算得出的。在構成住宅物業的一部份的其他指明項目 (如有) 的面積 (不計算入實用面積), 是按照《一手住宅物業銷售條例》附表2第2部計算得出的。

## 備註:

- 上述所列之面積以1平方米 = 10.764平方呎換算至平方呎, 並四捨五入至整數。平方呎與平方米之數字可能有些微差異。
- 期數住宅物業並無陽台。
- 所有座數不設4樓、13樓、14樓及24樓。

Description of Residential Property 物業的描述			Saleable Area (including balcony, utility platform and verandah, if any) sq. metre (sq.ft.) 實用面積 (包括露台, 工作平台及陽台 (如有)) 平方米 (平方呎)	Area of other specified items (Not included in the Saleable Area) sq. metre (sq.ft.) 其他指明項目的面積 (不計算入實用面積) 平方米 (平方呎)										
Tower Name 大廈名稱	Floor 樓層	Unit 單位		Air-conditioning plant room 空調機房	Bay window 窗台	Cockloft 閣樓	Flat roof 平台	Garden 花園	Parking space 停車位	Roof 天台	Stairhood 梯屋	Terrace 前庭	Yard 庭院	
Tower 5 (5A) 第5座 (5A)	5/F 5樓	A	47.966 ( 516 ) Balcony 露台: 3.694 ( 40 ) Utility Platform 工作平台: 1.500 ( 16 )	-	-	-	-	-	-	-	-	-	-	
		B	41.217 ( 444 ) Balcony 露台: 2.001 ( 22 ) Utility Platform 工作平台: 1.500 ( 16 )	-	-	-	-	-	-	-	-	-	-	-
		C	71.275 ( 767 ) Balcony 露台: 4.025 ( 43 ) Utility Platform 工作平台: 1.500 ( 16 )	-	-	-	-	-	-	-	-	-	-	-
		D	41.284 ( 444 ) Balcony 露台: 2.222 ( 24 ) Utility Platform 工作平台: 1.500 ( 16 )	-	-	-	-	-	-	-	-	-	-	-
		E	40.796 ( 439 ) Balcony 露台: 2.001 ( 22 ) Utility Platform 工作平台: 1.500 ( 16 )	-	-	-	-	-	-	-	-	-	-	-
		F	32.502 ( 350 ) Balcony 露台: 2.001 ( 22 ) Utility Platform 工作平台: 1.500 ( 16 )	-	-	-	-	-	-	-	-	-	-	-
		G	32.981 ( 355 ) Balcony 露台: 2.001 ( 22 ) Utility Platform 工作平台: 1.500 ( 16 )	-	-	-	-	-	-	-	-	-	-	-
		J	25.079 ( 270 ) Balcony 露台: - Utility Platform 工作平台: -	-	-	-	11.646 ( 125 )	-	-	-	-	-	-	-
		K	16.897 ( 182 ) Balcony 露台: - Utility Platform 工作平台: -	-	-	-	13.880 ( 149 )	-	-	-	-	-	-	-
		M	19.350 ( 208 ) Balcony 露台: 2.005 ( 22 ) Utility Platform 工作平台: -	-	-	-	-	-	-	-	-	-	-	-
N	21.965 ( 236 ) Balcony 露台: 2.005 ( 22 ) Utility Platform 工作平台: -	-	-	-	-	-	-	-	-	-	-	-		

The saleable area of each residential property and the floor areas of balcony, utility platform and verandah (if any) to the extent that it forms part of the residential property are calculated in accordance with section 8 of the Residential Properties (First-hand Sales) Ordinance; and the areas of other specified items (if any) to the extent that they form part of the residential property (not included in the saleable area) are calculated in accordance with Part 2 of Schedule 2 of the Residential Properties (First-hand Sales) Ordinance.

## Notes:

- The above areas have been converted to square feet based on a conversion rate of 1 square metre=10.764 square feet and rounded off to the nearest integer and may be slightly different from that shown in square metre.
- There is no verandah in the residential properties in the Phase.
- 4/F, 13/F, 14/F, 24/F for all Towers are omitted.

每個住宅物業的實用面積、以及構成住宅物業的一部份的範圍內的露台、工作平台及陽台 (如有) 之樓面面積, 是按照《一手住宅物業銷售條例》第8條計算得出的。在構成住宅物業的一部份的其他指明項目 (如有) 的面積 (不計算入實用面積), 是按照《一手住宅物業銷售條例》附表2第2部計算得出的。

## 備註:

- 上述所列之面積以1平方米 = 10.764平方呎換算至平方呎, 並四捨五入至整數。平方呎與平方米之數字可能有些微差異。
- 期數住宅物業並無陽台。
- 所有座數不設4樓、13樓、14樓及24樓。

Description of Residential Property 物業的描述			Saleable Area (including balcony, utility platform and verandah, if any) sq. metre (sq.ft.) 實用面積 (包括露台, 工作平台及陽台 (如有)) 平方米 (平方呎)	Area of other specified items (Not included in the Saleable Area) sq. metre (sq.ft.) 其他指明項目的面積 (不計算入實用面積) 平方米 (平方呎)										
Tower Name 大廈名稱	Floor 樓層	Unit 單位		Air-conditioning plant room 空調機房	Bay window 窗台	Cockloft 閣樓	Flat roof 平台	Garden 花園	Parking space 停車位	Roof 天台	Stairhood 梯屋	Terrace 前庭	Yard 庭院	
Tower 5 (5A) 第5座 (5A)	5/F 5樓	P	29.426 ( 317 ) Balcony 露台: 2.222 ( 24 ) Utility Platform 工作平台: 1.500 ( 16 )	-	-	-	-	-	-	-	-	-	-	
		Q	29.288 ( 315 ) Balcony 露台: 2.248 ( 24 ) Utility Platform 工作平台: 1.500 ( 16 )	-	-	-	-	-	-	-	-	-	-	-
		R	31.345 ( 337 ) Balcony 露台: 2.001 ( 22 ) Utility Platform 工作平台: 1.500 ( 16 )	-	-	-	-	-	-	-	-	-	-	-
Tower 5 (5A) 第5座 (5A)	6/F 6樓	A	47.966 ( 516 ) Balcony 露台: 3.694 ( 40 ) Utility Platform 工作平台: 1.500 ( 16 )	-	-	-	-	-	-	-	-	-	-	
		B	41.217 ( 444 ) Balcony 露台: 2.001 ( 22 ) Utility Platform 工作平台: 1.500 ( 16 )	-	-	-	-	-	-	-	-	-	-	
		C	71.275 ( 767 ) Balcony 露台: 4.025 ( 43 ) Utility Platform 工作平台: 1.500 ( 16 )	-	-	-	-	-	-	-	-	-	-	-
		D	41.284 ( 444 ) Balcony 露台: 2.222 ( 24 ) Utility Platform 工作平台: 1.500 ( 16 )	-	-	-	-	-	-	-	-	-	-	-
		E	40.796 ( 439 ) Balcony 露台: 2.001 ( 22 ) Utility Platform 工作平台: 1.500 ( 16 )	-	-	-	-	-	-	-	-	-	-	-
		F	32.502 ( 350 ) Balcony 露台: 2.001 ( 22 ) Utility Platform 工作平台: 1.500 ( 16 )	-	-	-	-	-	-	-	-	-	-	-
		G	32.981 ( 355 ) Balcony 露台: 2.001 ( 22 ) Utility Platform 工作平台: 1.500 ( 16 )	-	-	-	-	-	-	-	-	-	-	-
		H	25.112 ( 270 ) Balcony 露台: - Utility Platform 工作平台: -	-	-	-	8.498 ( 91 )	-	-	-	-	-	-	-
		J	28.007 ( 301 ) Balcony 露台: 2.039 ( 22 ) Utility Platform 工作平台: 1.500 ( 16 )	-	-	-	-	-	-	-	-	-	-	-

The saleable area of each residential property and the floor areas of balcony, utility platform and verandah (if any) to the extent that it forms part of the residential property are calculated in accordance with section 8 of the Residential Properties (First-hand Sales) Ordinance; and the areas of other specified items (if any) to the extent that they form part of the residential property (not included in the saleable area) are calculated in accordance with Part 2 of Schedule 2 of the Residential Properties (First-hand Sales) Ordinance.

## Notes:

- The above areas have been converted to square feet based on a conversion rate of 1 square metre=10.764 square feet and rounded off to the nearest integer and may be slightly different from that shown in square metre.
- There is no verandah in the residential properties in the Phase.
- 4/F, 13/F, 14/F, 24/F for all Towers are omitted.

每個住宅物業的實用面積、以及構成住宅物業的一部份的範圍內的露台、工作平台及陽台 (如有) 之樓面面積, 是按照《一手住宅物業銷售條例》第8條計算得出的。在構成住宅物業的一部份的其他指明項目 (如有) 的面積 (不計算入實用面積), 是按照《一手住宅物業銷售條例》附表2第2部計算得出的。

## 備註:

- 上述所列之面積以1平方米 = 10.764平方呎換算至平方呎, 並四捨五入至整數。平方呎與平方米之數字可能有些微差異。
- 期數住宅物業並無陽台。
- 所有座數不設4樓、13樓、14樓及24樓。

Description of Residential Property 物業的描述			Saleable Area (including balcony, utility platform and verandah, if any) sq. metre (sq.ft.) 實用面積 (包括露台, 工作平台及陽台 (如有)) 平方米 (平方呎)	Area of other specified items (Not included in the Saleable Area) sq. metre (sq.ft.) 其他指明項目的面積 (不計算入實用面積) 平方米 (平方呎)								
Tower Name 大廈名稱	Floor 樓層	Unit 單位		Air-conditioning plant room 空調機房	Bay window 窗台	Cockloft 閣樓	Flat roof 平台	Garden 花園	Parking space 停車位	Roof 天台	Stairhood 梯屋	Terrace 前庭
Tower 5 (5A) 第5座 (5A)	6/F 6樓	K	19.121 ( 206 ) Balcony 露台 : 2.224 ( 24 ) Utility Platform 工作平台 : -	-	-	-	-	-	-	-	-	-
		M	19.350 ( 208 ) Balcony 露台 : 2.005 ( 22 ) Utility Platform 工作平台 : -	-	-	-	-	-	-	-	-	-
		N	21.965 ( 236 ) Balcony 露台 : 2.005 ( 22 ) Utility Platform 工作平台 : -	-	-	-	-	-	-	-	-	-
		P	29.426 ( 317 ) Balcony 露台 : 2.222 ( 24 ) Utility Platform 工作平台 : 1.500 ( 16 )	-	-	-	-	-	-	-	-	-
		Q	29.288 ( 315 ) Balcony 露台 : 2.248 ( 24 ) Utility Platform 工作平台 : 1.500 ( 16 )	-	-	-	-	-	-	-	-	-
		R	31.345 ( 337 ) Balcony 露台 : 2.001 ( 22 ) Utility Platform 工作平台 : 1.500 ( 16 )	-	-	-	-	-	-	-	-	-

The saleable area of each residential property and the floor areas of balcony, utility platform and verandah (if any) to the extent that it forms part of the residential property are calculated in accordance with section 8 of the Residential Properties (First-hand Sales) Ordinance; and the areas of other specified items (if any) to the extent that they form part of the residential property (not included in the saleable area) are calculated in accordance with Part 2 of Schedule 2 of the Residential Properties (First-hand Sales) Ordinance.

## Notes:

- The above areas have been converted to square feet based on a conversion rate of 1 square metre=10.764 square feet and rounded off to the nearest integer and may be slightly different from that shown in square metre.
- There is no verandah in the residential properties in the Phase.
- 4/F, 13/F, 14/F, 24/F for all Towers are omitted.

每個住宅物業的實用面積、以及構成住宅物業的一部份的範圍內的露台、工作平台及陽台 (如有) 之樓面面積, 是按照《一手住宅物業銷售條例》第8條計算得出的。在構成住宅物業的一部份的其他指明項目 (如有) 的面積 (不計算入實用面積), 是按照《一手住宅物業銷售條例》附表2第2部計算得出的。

## 備註:

- 上述所列之面積以1平方米 = 10.764平方呎換算至平方呎, 並四捨五入至整數。平方呎與平方米之數字可能有些微差異。
- 期數住宅物業並無陽台。
- 所有座數不設4樓、13樓、14樓及24樓。

Description of Residential Property 物業的描述			Saleable Area (including balcony, utility platform and verandah, if any) sq. metre (sq.ft.) 實用面積 (包括露台, 工作平台及陽台 (如有)) 平方米 (平方呎)	Area of other specified items (Not included in the Saleable Area) sq. metre (sq.ft.) 其他指明項目的面積 (不計算入實用面積) 平方米 (平方呎)										
Tower Name 大廈名稱	Floor 樓層	Unit 單位		Air-conditioning plant room 空調機房	Bay window 窗台	Cockloft 閣樓	Flat roof 平台	Garden 花園	Parking space 停車位	Roof 天台	Stairhood 梯屋	Terrace 前庭	Yard 庭院	
Tower 5 (5A) 第5座 (5A)	7/F 7樓	A	47.966 ( 516 ) Balcony 露台: 3.694 ( 40 ) Utility Platform 工作平台: 1.500 ( 16 )	-	-	-	-	-	-	-	-	-	-	
		B	41.217 ( 444 ) Balcony 露台: 2.001 ( 22 ) Utility Platform 工作平台: 1.500 ( 16 )	-	-	-	-	-	-	-	-	-	-	-
		C	71.275 ( 767 ) Balcony 露台: 4.025 ( 43 ) Utility Platform 工作平台: 1.500 ( 16 )	-	-	-	-	-	-	-	-	-	-	-
		D	41.284 ( 444 ) Balcony 露台: 2.222 ( 24 ) Utility Platform 工作平台: 1.500 ( 16 )	-	-	-	-	-	-	-	-	-	-	-
		E	40.796 ( 439 ) Balcony 露台: 2.001 ( 22 ) Utility Platform 工作平台: 1.500 ( 16 )	-	-	-	-	-	-	-	-	-	-	-
		F	32.502 ( 350 ) Balcony 露台: 2.001 ( 22 ) Utility Platform 工作平台: 1.500 ( 16 )	-	-	-	-	-	-	-	-	-	-	-
		G	32.981 ( 355 ) Balcony 露台: 2.001 ( 22 ) Utility Platform 工作平台: 1.500 ( 16 )	-	-	-	-	-	-	-	-	-	-	-
		H	28.025 ( 302 ) Balcony 露台: 2.129 ( 23 ) Utility Platform 工作平台: 1.500 ( 16 )	-	-	-	-	-	-	-	-	-	-	-
		J	28.007 ( 301 ) Balcony 露台: 2.039 ( 22 ) Utility Platform 工作平台: 1.500 ( 16 )	-	-	-	-	-	-	-	-	-	-	-
		K	19.121 ( 206 ) Balcony 露台: 2.224 ( 24 ) Utility Platform 工作平台: -	-	-	-	-	-	-	-	-	-	-	-
		M	19.350 ( 208 ) Balcony 露台: 2.005 ( 22 ) Utility Platform 工作平台: -	-	-	-	-	-	-	-	-	-	-	-
		N	21.965 ( 236 ) Balcony 露台: 2.005 ( 22 ) Utility Platform 工作平台: -	-	-	-	-	-	-	-	-	-	-	-
P	29.426 ( 317 ) Balcony 露台: 2.222 ( 24 ) Utility Platform 工作平台: 1.500 ( 16 )	-	-	-	-	-	-	-	-	-	-	-		

The saleable area of each residential property and the floor areas of balcony, utility platform and verandah (if any) to the extent that it forms part of the residential property are calculated in accordance with section 8 of the Residential Properties (First-hand Sales) Ordinance; and the areas of other specified items (if any) to the extent that they form part of the residential property (not included in the saleable area) are calculated in accordance with Part 2 of Schedule 2 of the Residential Properties (First-hand Sales) Ordinance.

## Notes:

- The above areas have been converted to square feet based on a conversion rate of 1 square metre=10.764 square feet and rounded off to the nearest integer and may be slightly different from that shown in square metre.
- There is no verandah in the residential properties in the Phase.
- 4/F, 13/F, 14/F, 24/F for all Towers are omitted.

每個住宅物業的實用面積、以及構成住宅物業的一部份的範圍內的露台、工作平台及陽台 (如有) 之樓面面積, 是按照《一手住宅物業銷售條例》第8條計算得出的。在構成住宅物業的一部份的其他指明項目 (如有) 的面積 (不計算入實用面積), 是按照《一手住宅物業銷售條例》附表2第2部計算得出的。

## 備註:

- 上述所列之面積以1平方米 = 10.764平方呎換算至平方呎, 並四捨五入至整數。平方呎與平方米之數字可能有些微差異。
- 期數住宅物業並無陽台。
- 所有座數不設4樓、13樓、14樓及24樓。

Description of Residential Property 物業的描述			Saleable Area (including balcony, utility platform and verandah, if any) sq. metre (sq.ft.) 實用面積 (包括露台, 工作平台及陽台 (如有)) 平方米 (平方呎)	Area of other specified items (Not included in the Saleable Area) sq. metre (sq.ft.) 其他指明項目的面積 (不計算入實用面積) 平方米 (平方呎)									
Tower Name 大廈名稱	Floor 樓層	Unit 單位		Air-conditioning plant room 空調機房	Bay window 窗台	Cockloft 閣樓	Flat roof 平台	Garden 花園	Parking space 停車位	Roof 天台	Stairhood 梯屋	Terrace 前庭	Yard 庭院
Tower 5 (5A) 第5座 (5A)	8/F 8樓	A	47.966 ( 516 ) Balcony 露台: 3.694 ( 40 ) Utility Platform 工作平台: 1.500 ( 16 )	-	-	-	-	-	-	-	-	-	-
		B	41.217 ( 444 ) Balcony 露台: 2.001 ( 22 ) Utility Platform 工作平台: 1.500 ( 16 )	-	-	-	-	-	-	-	-	-	-
		C	71.275 ( 767 ) Balcony 露台: 4.025 ( 43 ) Utility Platform 工作平台: 1.500 ( 16 )	-	-	-	-	-	-	-	-	-	-
		D	41.284 ( 444 ) Balcony 露台: 2.222 ( 24 ) Utility Platform 工作平台: 1.500 ( 16 )	-	-	-	-	-	-	-	-	-	-
		E	40.796 ( 439 ) Balcony 露台: 2.001 ( 22 ) Utility Platform 工作平台: 1.500 ( 16 )	-	-	-	-	-	-	-	-	-	-
		F	32.502 ( 350 ) Balcony 露台: 2.001 ( 22 ) Utility Platform 工作平台: 1.500 ( 16 )	-	-	-	-	-	-	-	-	-	-
		G	32.981 ( 355 ) Balcony 露台: 2.001 ( 22 ) Utility Platform 工作平台: 1.500 ( 16 )	-	-	-	-	-	-	-	-	-	-
		H	27.897 ( 300 ) Balcony 露台: 2.001 ( 22 ) Utility Platform 工作平台: 1.500 ( 16 )	-	-	-	-	-	-	-	-	-	-
		J	28.007 ( 301 ) Balcony 露台: 2.039 ( 22 ) Utility Platform 工作平台: 1.500 ( 16 )	-	-	-	-	-	-	-	-	-	-
		K	19.121 ( 206 ) Balcony 露台: 2.224 ( 24 ) Utility Platform 工作平台: -	-	-	-	-	-	-	-	-	-	-
		M	19.350 ( 208 ) Balcony 露台: 2.005 ( 22 ) Utility Platform 工作平台: -	-	-	-	-	-	-	-	-	-	-
		N	21.965 ( 236 ) Balcony 露台: 2.005 ( 22 ) Utility Platform 工作平台: -	-	-	-	-	-	-	-	-	-	-
P	29.426 ( 317 ) Balcony 露台: 2.222 ( 24 ) Utility Platform 工作平台: 1.500 ( 16 )	-	-	-	-	-	-	-	-	-	-		

The saleable area of each residential property and the floor areas of balcony, utility platform and verandah (if any) to the extent that it forms part of the residential property are calculated in accordance with section 8 of the Residential Properties (First-hand Sales) Ordinance; and the areas of other specified items (if any) to the extent that they form part of the residential property (not included in the saleable area) are calculated in accordance with Part 2 of Schedule 2 of the Residential Properties (First-hand Sales) Ordinance.

## Notes:

- The above areas have been converted to square feet based on a conversion rate of 1 square metre=10.764 square feet and rounded off to the nearest integer and may be slightly different from that shown in square metre.
- There is no verandah in the residential properties in the Phase.
- 4/F, 13/F, 14/F, 24/F for all Towers are omitted.

每個住宅物業的實用面積、以及構成住宅物業的一部份的範圍內的露台、工作平台及陽台(如有)之樓面面積,是按照《一手住宅物業銷售條例》第8條計算得出的。在構成住宅物業的一部份的其他指明項目(如有)的面積(不計算入實用面積),是按照《一手住宅物業銷售條例》附表2第2部計算得出的。

## 備註:

- 上述所列之面積以1平方米=10.764平方呎換算至平方呎,並四捨五入至整數。平方呎與平方米之數字可能有些微差異。
- 期數住宅物業並無陽台。
- 所有座數不設4樓、13樓、14樓及24樓。

Description of Residential Property 物業的描述			Saleable Area (including balcony, utility platform and verandah, if any) sq. metre (sq.ft.) 實用面積 (包括露台, 工作平台及陽台 (如有)) 平方米 (平方呎)	Area of other specified items (Not included in the Saleable Area) sq. metre (sq.ft.) 其他指明項目的面積 (不計算入實用面積) 平方米 (平方呎)										
Tower Name 大廈名稱	Floor 樓層	Unit 單位		Air-conditioning plant room 空調機房	Bay window 窗台	Cockloft 閣樓	Flat roof 平台	Garden 花園	Parking space 停車位	Roof 天台	Stairhood 梯屋	Terrace 前庭	Yard 庭院	
Tower 5 (5A) 第5座 (5A)	9/F 9樓	A	47.966 ( 516 ) Balcony 露台: 3.694 ( 40 ) Utility Platform 工作平台: 1.500 ( 16 )	-	-	-	-	-	-	-	-	-	-	
		B	41.217 ( 444 ) Balcony 露台: 2.001 ( 22 ) Utility Platform 工作平台: 1.500 ( 16 )	-	-	-	-	-	-	-	-	-	-	-
		C	71.275 ( 767 ) Balcony 露台: 4.025 ( 43 ) Utility Platform 工作平台: 1.500 ( 16 )	-	-	-	-	-	-	-	-	-	-	-
		D	41.284 ( 444 ) Balcony 露台: 2.222 ( 24 ) Utility Platform 工作平台: 1.500 ( 16 )	-	-	-	-	-	-	-	-	-	-	-
		E	40.796 ( 439 ) Balcony 露台: 2.001 ( 22 ) Utility Platform 工作平台: 1.500 ( 16 )	-	-	-	-	-	-	-	-	-	-	-
		F	32.502 ( 350 ) Balcony 露台: 2.001 ( 22 ) Utility Platform 工作平台: 1.500 ( 16 )	-	-	-	-	-	-	-	-	-	-	-
		G	32.981 ( 355 ) Balcony 露台: 2.001 ( 22 ) Utility Platform 工作平台: 1.500 ( 16 )	-	-	-	-	-	-	-	-	-	-	-
		H	27.897 ( 300 ) Balcony 露台: 2.001 ( 22 ) Utility Platform 工作平台: 1.500 ( 16 )	-	-	-	-	-	-	-	-	-	-	-
		J	28.007 ( 301 ) Balcony 露台: 2.039 ( 22 ) Utility Platform 工作平台: 1.500 ( 16 )	-	-	-	-	-	-	-	-	-	-	-
		K	19.121 ( 206 ) Balcony 露台: 2.224 ( 24 ) Utility Platform 工作平台: -	-	-	-	-	-	-	-	-	-	-	-
		M	19.350 ( 208 ) Balcony 露台: 2.005 ( 22 ) Utility Platform 工作平台: -	-	-	-	-	-	-	-	-	-	-	-
		N	21.965 ( 236 ) Balcony 露台: 2.005 ( 22 ) Utility Platform 工作平台: -	-	-	-	-	-	-	-	-	-	-	-
P	29.426 ( 317 ) Balcony 露台: 2.222 ( 24 ) Utility Platform 工作平台: 1.500 ( 16 )	-	-	-	-	-	-	-	-	-	-	-		

The saleable area of each residential property and the floor areas of balcony, utility platform and verandah (if any) to the extent that it forms part of the residential property are calculated in accordance with section 8 of the Residential Properties (First-hand Sales) Ordinance; and the areas of other specified items (if any) to the extent that they form part of the residential property (not included in the saleable area) are calculated in accordance with Part 2 of Schedule 2 of the Residential Properties (First-hand Sales) Ordinance.

## Notes:

- The above areas have been converted to square feet based on a conversion rate of 1 square metre=10.764 square feet and rounded off to the nearest integer and may be slightly different from that shown in square metre.
- There is no verandah in the residential properties in the Phase.
- 4/F, 13/F, 14/F, 24/F for all Towers are omitted.

每個住宅物業的實用面積、以及構成住宅物業的一部份的範圍內的露台、工作平台及陽台(如有)之樓面面積,是按照《一手住宅物業銷售條例》第8條計算得出的。在構成住宅物業的一部份的其他指明項目(如有)的面積(不計算入實用面積),是按照《一手住宅物業銷售條例》附表2第2部計算得出的。

## 備註:

- 上述所列之面積以1平方米=10.764平方呎換算至平方呎,並四捨五入至整數。平方呎與平方米之數字可能有些微差異。
- 期數住宅物業並無陽台。
- 所有座數不設4樓、13樓、14樓及24樓。



Description of Residential Property 物業的描述			Saleable Area (including balcony, utility platform and verandah, if any) sq. metre (sq.ft.) 實用面積 (包括露台, 工作平台及陽台 (如有)) 平方米 (平方呎)	Area of other specified items (Not included in the Saleable Area) sq. metre (sq.ft.) 其他指明項目的面積 (不計算入實用面積) 平方米 (平方呎)										
Tower Name 大廈名稱	Floor 樓層	Unit 單位		Air-conditioning plant room 空調機房	Bay window 窗台	Cockloft 閣樓	Flat roof 平台	Garden 花園	Parking space 停車位	Roof 天台	Stairhood 梯屋	Terrace 前庭	Yard 庭院	
Tower 5 (5A) 第5座 (5A)	10/F - 12/F, 15/F - 23/F & 25/F 10樓至 12樓、 15樓至 23樓及 25樓	A	47.966 ( 516 ) Balcony 露台: 3.694 ( 40 ) Utility Platform 工作平台: 1.500 ( 16 )	-	-	-	-	-	-	-	-	-	-	
		B	41.217 ( 444 ) Balcony 露台: 2.001 ( 22 ) Utility Platform 工作平台: 1.500 ( 16 )	-	-	-	-	-	-	-	-	-	-	-
		C	71.275 ( 767 ) Balcony 露台: 4.025 ( 43 ) Utility Platform 工作平台: 1.500 ( 16 )	-	-	-	-	-	-	-	-	-	-	-
		D	41.284 ( 444 ) Balcony 露台: 2.222 ( 24 ) Utility Platform 工作平台: 1.500 ( 16 )	-	-	-	-	-	-	-	-	-	-	-
		E	40.796 ( 439 ) Balcony 露台: 2.001 ( 22 ) Utility Platform 工作平台: 1.500 ( 16 )	-	-	-	-	-	-	-	-	-	-	-
		F	32.502 ( 350 ) Balcony 露台: 2.001 ( 22 ) Utility Platform 工作平台: 1.500 ( 16 )	-	-	-	-	-	-	-	-	-	-	-
		G	32.981 ( 355 ) Balcony 露台: 2.001 ( 22 ) Utility Platform 工作平台: 1.500 ( 16 )	-	-	-	-	-	-	-	-	-	-	-
		H	27.897 ( 300 ) Balcony 露台: 2.001 ( 22 ) Utility Platform 工作平台: 1.500 ( 16 )	-	-	-	-	-	-	-	-	-	-	-
		J	28.007 ( 301 ) Balcony 露台: 2.039 ( 22 ) Utility Platform 工作平台: 1.500 ( 16 )	-	-	-	-	-	-	-	-	-	-	-
		K	19.121 ( 206 ) Balcony 露台: 2.224 ( 24 ) Utility Platform 工作平台: -	-	-	-	-	-	-	-	-	-	-	-
		M	19.350 ( 208 ) Balcony 露台: 2.005 ( 22 ) Utility Platform 工作平台: -	-	-	-	-	-	-	-	-	-	-	-
		N	21.965 ( 236 ) Balcony 露台: 2.005 ( 22 ) Utility Platform 工作平台: -	-	-	-	-	-	-	-	-	-	-	-
P	29.426 ( 317 ) Balcony 露台: 2.222 ( 24 ) Utility Platform 工作平台: 1.500 ( 16 )	-	-	-	-	-	-	-	-	-	-	-		

The saleable area of each residential property and the floor areas of balcony, utility platform and verandah (if any) to the extent that it forms part of the residential property are calculated in accordance with section 8 of the Residential Properties (First-hand Sales) Ordinance; and the areas of other specified items (if any) to the extent that they form part of the residential property (not included in the saleable area) are calculated in accordance with Part 2 of Schedule 2 of the Residential Properties (First-hand Sales) Ordinance.

## Notes:

- The above areas have been converted to square feet based on a conversion rate of 1 square metre=10.764 square feet and rounded off to the nearest integer and may be slightly different from that shown in square metre.
- There is no verandah in the residential properties in the Phase.
- 4/F, 13/F, 14/F, 24/F for all Towers are omitted.

每個住宅物業的實用面積、以及構成住宅物業的一部份的範圍內的露台、工作平台及陽台(如有)之樓面面積,是按照《一手住宅物業銷售條例》第8條計算得出的。在構成住宅物業的一部份的其他指明項目(如有)的面積(不計算入實用面積),是按照《一手住宅物業銷售條例》附表2第2部計算得出的。

## 備註:

- 上述所列之面積以1平方米=10.764平方呎換算至平方呎,並四捨五入至整數。平方呎與平方米之數字可能有些微差異。
- 期數住宅物業並無陽台。
- 所有座數不設4樓、13樓、14樓及24樓。

Description of Residential Property 物業的描述			Saleable Area (including balcony, utility platform and verandah, if any) sq. metre (sq.ft.) 實用面積 (包括露台, 工作平台及陽台 (如有)) 平方米 (平方呎)	Area of other specified items (Not included in the Saleable Area) sq. metre (sq.ft.) 其他指明項目的面積 (不計算入實用面積) 平方米 (平方呎)									
Tower Name 大廈名稱	Floor 樓層	Unit 單位		Air-conditioning plant room 空調機房	Bay window 窗台	Cockloft 閣樓	Flat roof 平台	Garden 花園	Parking space 停車位	Roof 天台	Stairhood 梯屋	Terrace 前庭	Yard 庭院
Tower 5 (5A) 第5座 (5A)	26/F 26樓	A	47.966 ( 516 ) Balcony 露台: 3.694 ( 40 ) Utility Platform 工作平台: 1.500 ( 16 )	-	-	-	-	-	-	42.146 ( 454 )	-	-	-
		B	41.217 ( 444 ) Balcony 露台: 2.001 ( 22 ) Utility Platform 工作平台: 1.500 ( 16 )	-	-	-	-	-	-	35.880 ( 386 )	-	-	-
		C	71.275 ( 767 ) Balcony 露台: 4.025 ( 43 ) Utility Platform 工作平台: 1.500 ( 16 )	-	-	-	-	-	-	57.783 ( 622 )	-	-	-
		D	41.284 ( 444 ) Balcony 露台: 2.222 ( 24 ) Utility Platform 工作平台: 1.500 ( 16 )	-	-	-	-	-	-	36.699 ( 395 )	-	-	-
		E	40.796 ( 439 ) Balcony 露台: 2.001 ( 22 ) Utility Platform 工作平台: 1.500 ( 16 )	-	-	-	-	-	-	27.713 ( 298 )	-	-	-
		F	32.502 ( 350 ) Balcony 露台: 2.001 ( 22 ) Utility Platform 工作平台: 1.500 ( 16 )	-	-	-	-	-	-	27.350 ( 294 )	-	-	-
		G	32.981 ( 355 ) Balcony 露台: 2.001 ( 22 ) Utility Platform 工作平台: 1.500 ( 16 )	-	-	-	-	-	-	27.972 ( 301 )	-	-	-
		H	27.897 ( 300 ) Balcony 露台: 2.001 ( 22 ) Utility Platform 工作平台: 1.500 ( 16 )	-	-	-	-	-	-	10.392 ( 112 )	-	-	-
		J	28.007 ( 301 ) Balcony 露台: 2.039 ( 22 ) Utility Platform 工作平台: 1.500 ( 16 )	-	-	-	-	-	-	10.864 ( 117 )	-	-	-
		K	19.121 ( 206 ) Balcony 露台: 2.224 ( 24 ) Utility Platform 工作平台: -	-	-	-	-	-	-	8.118 ( 87 )	-	-	-
		M	19.350 ( 208 ) Balcony 露台: 2.005 ( 22 ) Utility Platform 工作平台: -	-	-	-	-	-	-	12.671 ( 136 )	-	-	-
		N	21.965 ( 236 ) Balcony 露台: 2.005 ( 22 ) Utility Platform 工作平台: -	-	-	-	-	-	-	16.483 ( 177 )	-	-	-
P	29.426 ( 317 ) Balcony 露台: 2.222 ( 24 ) Utility Platform 工作平台: 1.500 ( 16 )	-	-	-	-	-	-	23.762 ( 256 )	-	-	-		

The saleable area of each residential property and the floor areas of balcony, utility platform and verandah (if any) to the extent that it forms part of the residential property are calculated in accordance with section 8 of the Residential Properties (First-hand Sales) Ordinance; and the areas of other specified items (if any) to the extent that they form part of the residential property (not included in the saleable area) are calculated in accordance with Part 2 of Schedule 2 of the Residential Properties (First-hand Sales) Ordinance.

## Notes:

- The above areas have been converted to square feet based on a conversion rate of 1 square metre=10.764 square feet and rounded off to the nearest integer and may be slightly different from that shown in square metre.
- There is no verandah in the residential properties in the Phase.
- 4/F, 13/F, 14/F, 24/F for all Towers are omitted.

每個住宅物業的實用面積、以及構成住宅物業的一部份的範圍內的露台、工作平台及陽台(如有)之樓面面積,是按照《一手住宅物業銷售條例》第8條計算得出的。在構成住宅物業的一部份的其他指明項目(如有)的面積(不計算入實用面積),是按照《一手住宅物業銷售條例》附表2第2部計算得出的。

## 備註:

- 上述所列之面積以1平方米=10.764平方呎換算至平方呎,並四捨五入至整數。平方呎與平方米之數字可能有些微差異。
- 期數住宅物業並無陽台。
- 所有座數不設4樓、13樓、14樓及24樓。

Description of Residential Property 物業的描述			Saleable Area (including balcony, utility platform and verandah, if any) sq. metre (sq.ft.) 實用面積(包括露台, 工作平台及陽台(如有))平方米(平方呎)	Area of other specified items (Not included in the Saleable Area) sq. metre (sq.ft.) 其他指明項目的面積(不計算入實用面積)平方米(平方呎)									
Tower Name 大廈名稱	Floor 樓層	Unit 單位		Air-conditioning plant room 空調機房	Bay window 窗台	Cockloft 閣樓	Flat roof 平台	Garden 花園	Parking space 停車位	Roof 天台	Stairhood 梯屋	Terrace 前庭	Yard 庭院
Tower 5 (5B) 第5座 (5B)	7/F 7樓	A	29.288 ( 315 ) Balcony 露台: 2.248 ( 24 ) Utility Platform 工作平台: 1.500 ( 16 )	-	-	-	-	-	-	-	-	-	-
		B	29.240 ( 315 ) Balcony 露台: 2.001 ( 22 ) Utility Platform 工作平台: 1.500 ( 16 )	-	-	-	-	-	-	-	-	-	-
		C	21.620 ( 233 ) Balcony 露台: 2.224 ( 24 ) Utility Platform 工作平台: -	-	-	-	-	-	-	-	-	-	-
		J	17.983 ( 194 ) Balcony 露台: - Utility Platform 工作平台: -	-	-	-	14.360 ( 155 )	-	-	-	-	-	-
		K	16.897 ( 182 ) Balcony 露台: - Utility Platform 工作平台: -	-	-	-	14.379 ( 155 )	-	-	-	-	-	-
		M	29.631 ( 319 ) Balcony 露台: 2.022 ( 22 ) Utility Platform 工作平台: 1.500 ( 16 )	-	-	-	-	-	-	-	-	-	-
		N	25.845 ( 278 ) Balcony 露台: - Utility Platform 工作平台: -	-	-	-	5.622 ( 61 )	-	-	-	-	-	-

The saleable area of each residential property and the floor areas of balcony, utility platform and verandah (if any) to the extent that it forms part of the residential property are calculated in accordance with section 8 of the Residential Properties (First-hand Sales) Ordinance; and the areas of other specified items (if any) to the extent that they form part of the residential property (not included in the saleable area) are calculated in accordance with Part 2 of Schedule 2 of the Residential Properties (First-hand Sales) Ordinance.

## Notes:

1. The above areas have been converted to square feet based on a conversion rate of 1 square metre=10.764 square feet and rounded off to the nearest integer and may be slightly different from that shown in square metre.
2. There is no verandah in the residential properties in the Phase.
3. 4/F, 13/F, 14/F, 24/F for all Towers are omitted.

每個住宅物業的實用面積、以及構成住宅物業的一部份的範圍內的露台、工作平台及陽台(如有)之樓面面積,是按照《一手住宅物業銷售條例》第8條計算得出的。在構成住宅物業的一部份的其他指明項目(如有)的面積(不計算入實用面積),是按照《一手住宅物業銷售條例》附表2第2部計算得出的。

## 備註:

1. 上述所列之面積以1平方米=10.764平方呎換算至平方呎,並四捨五入至整數。平方呎與平方米之數字可能有些微差異。
2. 期數住宅物業並無陽台。
3. 所有座數不設4樓、13樓、14樓及24樓。

Description of Residential Property 物業的描述			Saleable Area (including balcony, utility platform and verandah, if any) sq. metre (sq.ft.) 實用面積 (包括露台, 工作平台及陽台 (如有)) 平方米 (平方呎)	Area of other specified items (Not included in the Saleable Area) sq. metre (sq.ft.) 其他指明項目的面積 (不計算入實用面積) 平方米 (平方呎)										
Tower Name 大廈名稱	Floor 樓層	Unit 單位		Air-conditioning plant room 空調機房	Bay window 窗台	Cockloft 閣樓	Flat roof 平台	Garden 花園	Parking space 停車位	Roof 天台	Stairhood 梯屋	Terrace 前庭	Yard 庭院	
Tower 5 (5B) 第5座 (5B)	8/F 8樓	A	29.288 ( 315 ) Balcony 露台: 2.248 ( 24 ) Utility Platform 工作平台: 1.500 ( 16 )	-	-	-	-	-	-	-	-	-	-	
		B	29.240 ( 315 ) Balcony 露台: 2.001 ( 22 ) Utility Platform 工作平台: 1.500 ( 16 )	-	-	-	-	-	-	-	-	-	-	-
		C	21.540 ( 232 ) Balcony 露台: 2.224 ( 24 ) Utility Platform 工作平台: -	-	-	-	-	-	-	-	-	-	-	-
		J	19.990 ( 215 ) Balcony 露台: 2.007 ( 22 ) Utility Platform 工作平台: -	-	-	-	-	-	-	-	-	-	-	-
		K	19.092 ( 206 ) Balcony 露台: 2.195 ( 24 ) Utility Platform 工作平台: -	-	-	-	-	-	-	-	-	-	-	-
		M	29.423 ( 317 ) Balcony 露台: 2.003 ( 22 ) Utility Platform 工作平台: 1.500 ( 16 )	-	-	-	-	-	-	-	-	-	-	-
		N	29.346 ( 316 ) Balcony 露台: 2.001 ( 22 ) Utility Platform 工作平台: 1.500 ( 16 )	-	-	-	-	-	-	-	-	-	-	-

The saleable area of each residential property and the floor areas of balcony, utility platform and verandah (if any) to the extent that it forms part of the residential property are calculated in accordance with section 8 of the Residential Properties (First-hand Sales) Ordinance; and the areas of other specified items (if any) to the extent that they form part of the residential property (not included in the saleable area) are calculated in accordance with Part 2 of Schedule 2 of the Residential Properties (First-hand Sales) Ordinance.

## Notes:

- The above areas have been converted to square feet based on a conversion rate of 1 square metre=10.764 square feet and rounded off to the nearest integer and may be slightly different from that shown in square metre.
- There is no verandah in the residential properties in the Phase.
- 4/F, 13/F, 14/F, 24/F for all Towers are omitted.

每個住宅物業的實用面積、以及構成住宅物業的一部份的範圍內的露台、工作平台及陽台 (如有) 之樓面面積, 是按照《一手住宅物業銷售條例》第8條計算得出的。在構成住宅物業的一部份的其他指明項目 (如有) 的面積 (不計算入實用面積), 是按照《一手住宅物業銷售條例》附表2第2部計算得出的。

## 備註:

- 上述所列之面積以1平方米 = 10.764平方呎換算至平方呎, 並四捨五入至整數。平方呎與平方米之數字可能有些微差異。
- 期數住宅物業並無陽台。
- 所有座數不設4樓、13樓、14樓及24樓。

Description of Residential Property 物業的描述			Saleable Area (including balcony, utility platform and verandah, if any) sq. metre (sq.ft.) 實用面積 (包括露台, 工作平台及陽台 (如有)) 平方米 (平方呎)	Area of other specified items (Not included in the Saleable Area) sq. metre (sq.ft.) 其他指明項目的面積 (不計算入實用面積) 平方米 (平方呎)										
Tower Name 大廈名稱	Floor 樓層	Unit 單位		Air-conditioning plant room 空調機房	Bay window 窗台	Cockloft 閣樓	Flat roof 平台	Garden 花園	Parking space 停車位	Roof 天台	Stairhood 梯屋	Terrace 前庭	Yard 庭院	
Tower 5 (5B) 第5座 (5B)	9/F 9樓	A	29.288 ( 315 ) Balcony 露台: 2.248 ( 24 ) Utility Platform 工作平台: 1.500 ( 16 )	-	-	-	-	-	-	-	-	-	-	
		B	29.240 ( 315 ) Balcony 露台: 2.001 ( 22 ) Utility Platform 工作平台: 1.500 ( 16 )	-	-	-	-	-	-	-	-	-	-	-
		C	20.627 ( 222 ) Balcony 露台: 2.224 ( 24 ) Utility Platform 工作平台: -	-	-	-	-	-	-	-	-	-	-	-
		D	18.466 ( 199 ) Balcony 露台: - Utility Platform 工作平台: -	-	-	-	7.337 ( 79 )	-	-	-	-	-	-	-
		E	18.416 ( 198 ) Balcony 露台: - Utility Platform 工作平台: -	-	-	-	7.936 ( 85 )	-	-	-	-	-	-	-
		F	29.114 ( 313 ) Balcony 露台: 2.004 ( 22 ) Utility Platform 工作平台: 1.500 ( 16 )	-	-	-	23.448 ( 252 )	-	-	-	-	-	-	-
		G	26.566 ( 286 ) Balcony 露台: - Utility Platform 工作平台: -	-	-	-	22.048 ( 237 )	-	-	-	-	-	-	-
		H	16.963 ( 183 ) Balcony 露台: - Utility Platform 工作平台: -	-	-	-	6.086 ( 66 )	-	-	-	-	-	-	-
		J	19.102 ( 206 ) Balcony 露台: 2.114 ( 23 ) Utility Platform 工作平台: -	-	-	-	-	-	-	-	-	-	-	-
		K	19.092 ( 206 ) Balcony 露台: 2.195 ( 24 ) Utility Platform 工作平台: -	-	-	-	-	-	-	-	-	-	-	-
		M	29.423 ( 317 ) Balcony 露台: 2.003 ( 22 ) Utility Platform 工作平台: 1.500 ( 16 )	-	-	-	-	-	-	-	-	-	-	-
N	29.346 ( 316 ) Balcony 露台: 2.001 ( 22 ) Utility Platform 工作平台: 1.500 ( 16 )	-	-	-	-	-	-	-	-	-	-	-		

The saleable area of each residential property and the floor areas of balcony, utility platform and verandah (if any) to the extent that it forms part of the residential property are calculated in accordance with section 8 of the Residential Properties (First-hand Sales) Ordinance; and the areas of other specified items (if any) to the extent that they form part of the residential property (not included in the saleable area) are calculated in accordance with Part 2 of Schedule 2 of the Residential Properties (First-hand Sales) Ordinance.

## Notes:

- The above areas have been converted to square feet based on a conversion rate of 1 square metre=10.764 square feet and rounded off to the nearest integer and may be slightly different from that shown in square metre.
- There is no verandah in the residential properties in the Phase.
- 4/F, 13/F, 14/F, 24/F for all Towers are omitted.

每個住宅物業的實用面積、以及構成住宅物業的一部份的範圍內的露台、工作平台及陽台 (如有) 之樓面面積, 是按照《一手住宅物業銷售條例》第8條計算得出的。在構成住宅物業的一部份的其他指明項目 (如有) 的面積 (不計算入實用面積), 是按照《一手住宅物業銷售條例》附表2第2部計算得出的。

## 備註:

- 上述所列之面積以1平方米 = 10.764平方呎換算至平方呎, 並四捨五入至整數。平方呎與平方米之數字可能有些微差異。
- 期數住宅物業並無陽台。
- 所有座數不設4樓、13樓、14樓及24樓。

Description of Residential Property 物業的描述			Saleable Area (including balcony, utility platform and verandah, if any) sq. metre (sq.ft.) 實用面積 (包括露台, 工作平台及陽台 (如有)) 平方米 (平方呎)	Area of other specified items (Not included in the Saleable Area) sq. metre (sq.ft.) 其他指明項目的面積 (不計算入實用面積) 平方米 (平方呎)											
Tower Name 大廈名稱	Floor 樓層	Unit 單位		Air-conditioning plant room 空調機房	Bay window 窗台	Cockloft 閣樓	Flat roof 平台	Garden 花園	Parking space 停車位	Roof 天台	Stairhood 梯屋	Terrace 前庭	Yard 庭院		
Tower 5 (5B) 第5座 (5B)	10/F - 12/F, 15/F - 23/F & 25/F 10樓至 12樓、 15樓至 23樓及 25樓	A	29.288 ( 315 ) Balcony 露台: 2.248 ( 24 ) Utility Platform 工作平台: 1.500 ( 16 )	-	-	-	-	-	-	-	-	-	-		
		B	29.240 ( 315 ) Balcony 露台: 2.001 ( 22 ) Utility Platform 工作平台: 1.500 ( 16 )	-	-	-	-	-	-	-	-	-	-	-	
		C	20.627 ( 222 ) Balcony 露台: 2.224 ( 24 ) Utility Platform 工作平台: -	-	-	-	-	-	-	-	-	-	-	-	
		D	20.471 ( 220 ) Balcony 露台: 2.005 ( 22 ) Utility Platform 工作平台: -	-	-	-	-	-	-	-	-	-	-	-	
		E	20.421 ( 220 ) Balcony 露台: 2.005 ( 22 ) Utility Platform 工作平台: -	-	-	-	-	-	-	-	-	-	-	-	
		F	29.114 ( 313 ) Balcony 露台: 2.004 ( 22 ) Utility Platform 工作平台: 1.500 ( 16 )	-	-	-	-	-	-	-	-	-	-	-	-
		G	30.504 ( 328 ) Balcony 露台: 2.438 ( 26 ) Utility Platform 工作平台: 1.500 ( 16 )	-	-	-	-	-	-	-	-	-	-	-	-
		H	18.970 ( 204 ) Balcony 露台: 2.007 ( 22 ) Utility Platform 工作平台: -	-	-	-	-	-	-	-	-	-	-	-	-
		J	18.995 ( 204 ) Balcony 露台: 2.007 ( 22 ) Utility Platform 工作平台: -	-	-	-	-	-	-	-	-	-	-	-	-
		K	19.092 ( 206 ) Balcony 露台: 2.195 ( 24 ) Utility Platform 工作平台: -	-	-	-	-	-	-	-	-	-	-	-	-
		M	29.423 ( 317 ) Balcony 露台: 2.003 ( 22 ) Utility Platform 工作平台: 1.500 ( 16 )	-	-	-	-	-	-	-	-	-	-	-	-
N	29.346 ( 316 ) Balcony 露台: 2.001 ( 22 ) Utility Platform 工作平台: 1.500 ( 16 )	-	-	-	-	-	-	-	-	-	-	-	-		

The saleable area of each residential property and the floor areas of balcony, utility platform and verandah (if any) to the extent that it forms part of the residential property are calculated in accordance with section 8 of the Residential Properties (First-hand Sales) Ordinance; and the areas of other specified items (if any) to the extent that they form part of the residential property (not included in the saleable area) are calculated in accordance with Part 2 of Schedule 2 of the Residential Properties (First-hand Sales) Ordinance.

## Notes:

- The above areas have been converted to square feet based on a conversion rate of 1 square metre=10.764 square feet and rounded off to the nearest integer and may be slightly different from that shown in square metre.
- There is no verandah in the residential properties in the Phase.
- 4/F, 13/F, 14/F, 24/F for all Towers are omitted.

每個住宅物業的實用面積、以及構成住宅物業的一部份的範圍內的露台、工作平台及陽台 (如有) 之樓面面積, 是按照《一手住宅物業銷售條例》第8條計算得出的。在構成住宅物業的一部份的其他指明項目 (如有) 的面積 (不計算入實用面積), 是按照《一手住宅物業銷售條例》附表2第2部計算得出的。

## 備註:

- 上述所列之面積以1平方米 = 10.764平方呎換算至平方呎, 並四捨五入至整數。平方呎與平方米之數字可能有些微差異。
- 期數住宅物業並無陽台。
- 所有座數不設4樓、13樓、14樓及24樓。

Description of Residential Property 物業的描述			Saleable Area (including balcony, utility platform and verandah, if any) sq. metre (sq.ft.) 實用面積 (包括露台, 工作平台及陽台 (如有)) 平方米 (平方呎)	Area of other specified items (Not included in the Saleable Area) sq. metre (sq.ft.) 其他指明項目的面積 (不計算入實用面積) 平方米 (平方呎)									
Tower Name 大廈名稱	Floor 樓層	Unit 單位		Air-conditioning plant room 空調機房	Bay window 窗台	Cockloft 閣樓	Flat roof 平台	Garden 花園	Parking space 停車位	Roof 天台	Stairhood 梯屋	Terrace 前庭	Yard 庭院
Tower 5 (5B) 第5座 (5B)	26/F 26樓	A	29.288 ( 315 ) Balcony 露台: 2.248 ( 24 ) Utility Platform 工作平台: 1.500 ( 16 )	-	-	-	-	-	-	20.078 ( 216 )	-	-	-
		B	29.240 ( 315 ) Balcony 露台: 2.001 ( 22 ) Utility Platform 工作平台: 1.500 ( 16 )	-	-	-	-	-	-	27.604 ( 297 )	-	-	-
		C	20.627 ( 222 ) Balcony 露台: 2.224 ( 24 ) Utility Platform 工作平台: -	-	-	-	-	-	-	17.111 ( 184 )	-	-	-
		D	20.471 ( 220 ) Balcony 露台: 2.005 ( 22 ) Utility Platform 工作平台: -	-	-	-	-	-	-	17.836 ( 192 )	-	-	-
		E	20.421 ( 220 ) Balcony 露台: 2.005 ( 22 ) Utility Platform 工作平台: -	-	-	-	-	-	-	16.597 ( 179 )	-	-	-
		F	29.114 ( 313 ) Balcony 露台: 2.004 ( 22 ) Utility Platform 工作平台: 1.500 ( 16 )	-	-	-	-	-	-	22.096 ( 238 )	-	-	-
		G	30.504 ( 328 ) Balcony 露台: 2.438 ( 26 ) Utility Platform 工作平台: 1.500 ( 16 )	-	-	-	-	-	-	27.763 ( 299 )	-	-	-
		H	18.970 ( 204 ) Balcony 露台: 2.007 ( 22 ) Utility Platform 工作平台: -	-	-	-	-	-	-	15.067 ( 162 )	-	-	-
		J	18.995 ( 204 ) Balcony 露台: 2.007 ( 22 ) Utility Platform 工作平台: -	-	-	-	-	-	-	-	-	-	-
		K	19.092 ( 206 ) Balcony 露台: 2.195 ( 24 ) Utility Platform 工作平台: -	-	-	-	-	-	-	-	-	-	-
		M	29.423 ( 317 ) Balcony 露台: 2.003 ( 22 ) Utility Platform 工作平台: 1.500 ( 16 )	-	-	-	-	-	-	-	11.548 ( 124 )	-	-
N	29.346 ( 316 ) Balcony 露台: 2.001 ( 22 ) Utility Platform 工作平台: 1.500 ( 16 )	-	-	-	-	-	-	-	13.031 ( 140 )	-	-	-	

The saleable area of each residential property and the floor areas of balcony, utility platform and verandah (if any) to the extent that it forms part of the residential property are calculated in accordance with section 8 of the Residential Properties (First-hand Sales) Ordinance; and the areas of other specified items (if any) to the extent that they form part of the residential property (not included in the saleable area) are calculated in accordance with Part 2 of Schedule 2 of the Residential Properties (First-hand Sales) Ordinance.

## Notes:

- The above areas have been converted to square feet based on a conversion rate of 1 square metre=10.764 square feet and rounded off to the nearest integer and may be slightly different from that shown in square metre.
- There is no verandah in the residential properties in the Phase.
- 4/F, 13/F, 14/F, 24/F for all Towers are omitted.

每個住宅物業的實用面積、以及構成住宅物業的一部份的範圍內的露台、工作平台及陽台(如有)之樓面面積,是按照《一手住宅物業銷售條例》第8條計算得出的。在構成住宅物業的一部份的其他指明項目(如有)的面積(不計算入實用面積),是按照《一手住宅物業銷售條例》附表2第2部計算得出的。

## 備註:

- 上述所列之面積以1平方米=10.764平方呎換算至平方呎,並四捨五入至整數。平方呎與平方米之數字可能有些微差異。
- 期數住宅物業並無陽台。
- 所有座數不設4樓、13樓、14樓及24樓。

G/F FLOOR PLAN  
地下樓面平面圖



**LEGEND 圖例**

- Residential Car Parking Space  
住宅停車位
- Residential Motorcycle Parking Space  
住宅電單車停車位
- Residential Visitor's Car Parking Space  
住宅訪客停車位
- Accessible Residential Visitor's Car Parking Space  
暢通易達住宅訪客停車位
- Residential Loading and Unloading Space  
住宅上落貨停車位
- Loading and Unloading Space for Refuse Collection Vehicles  
垃圾回收車上落停車位
- Common Loading and Unloading Area  
共用上落區
- Boundary of the Phase  
期數之邊界

Scale 0  25M/米  
比例



1/F FLOOR PLAN  
1樓樓面平面圖



**LEGEND 圖例**

- Residential Car Parking Space  
住宅停車位
- Bicycle Parking Space  
單車停車位
- Boundary of the Phase  
期數之邊界

Scale 0  25M/米  
比例

Floor 樓層	Category of parking spaces 停車位類別	Number 數目	Dimensions of each parking space (L x W) (m) 每個停車位尺寸(長 x 闊)(米)	Area of each parking space (sq.m.) 每個停車位面積(平方米)
1/F 一樓	Residential Car Parking Space 住宅停車位	23	5.0 x 2.5	12.5
	Bicycle Parking Space 單車停車位	42	1.8 x 0.5	0.9
G/F 地下	Residential Car Parking Space 住宅停車位	35	5.0 x 2.5	12.5
	Residential Motorcycle Parking Space 住宅電單車停車位	7	2.4 x 1.0	2.4
	Residential Visitor's Car Parking Space 住宅訪客停車位	7	5.0 x 2.5	12.5
	Accessible Residential Visitor's Car Parking Space 暢通易達住宅訪客停車位	1	5.0 x 3.5	17.5
	Accessible Residential Visitor's Car Parking Space (with Common Loading and Unloading Area) 暢通易達住宅訪客停車位(連同共用上落區)	2	5.0 x 2.5	12.5
	Residential Loading and Unloading Space 住宅上落貨停車位	2	11.0 x 3.5	38.5
	Loading and Unloading Space for Refuse Collection Vehicles 垃圾回收車上落停車位	1	12.0 x 5.0	60.0

1. A preliminary deposit of 5% of the purchase price is payable on the signing of the preliminary agreement for sale and purchase.
  2. The preliminary deposit paid by the purchaser on the signing of that preliminary agreement for sale and purchase will be held by a firm of solicitors acting for the Vendor (the owner), as stakeholders.
  3. If the purchaser fails to execute the formal agreement for sale and purchase within 5 working days after the date on which the purchaser enters into that preliminary agreement for sale and purchase –
    - (i) that preliminary agreement for sale and purchase is terminated;
    - (ii) the preliminary deposit is forfeited; and
    - (iii) the Vendor (the owner) does not have any further claim against the purchaser for the failure.
1. 在簽署臨時買賣合約時須支付款額為樓價之5%的臨時訂金。
  2. 買方在簽署該臨時買賣合約時支付的臨時訂金，會由代表賣方（擁有人）行事的律師事務所以保證金保存人的身份持有。
  3. 如買方沒有於訂立該臨時買賣合約的日期之後5個工作日內簽立正式買賣合約 –
    - (i) 該臨時買賣合約即告終止；
    - (ii) 有關的臨時訂金即予沒收；及
    - (iii) 賣方（擁有人）不得就買方沒有簽立正式買賣合約而針對買方提出進一步申索。

**A. The common parts of the Phase**

**“Common Areas”** means the Development Common Areas, the Residential Common Areas and the Car Park Common Areas.

**“Common Facilities”** means the Development Common Facilities, the Residential Common Facilities and the Car Park Common Facilities.

**“Car Park Common Areas”** means those parts of the Lot (as defined in the DMC) and the Development (as defined in the DMC) (excluding those parking spaces shown and delineated on the car park layout plan approved by the Building Authority) and all other common parts specified in Schedule 1 to the Building Management Ordinance (Cap.344) (if any) within the Lot and the Development designed or intended for the common use and benefit of the Owners (as defined in the DMC) of the Car Parks (as defined in the DMC) and the occupiers of the Visitors' Car Parks and the Accessible Car Parks and not otherwise specifically assigned to or for the exclusive use of the Owner of a particular Car Park and shall include but not limited to car park shuttle lift lobbies, driveways and ramps (which do not form part of the Development Common Areas or Residential Common Areas), drop curb, access areas, circulation passages, fan rooms (which do not form part of the Residential Common Areas), extra low voltage rooms, electrical rooms, electric meter rooms, vent ducts, smoke vents, smoke lobbies (which do not form part of the Development Common Areas or Residential Common Areas), cavity wall(s) (which do not form part of the Development Common Areas or Residential Common Areas), exit corridors and staircases (which do not form part of the Units (as defined in the DMC), Development Common Areas or Residential Common Areas). The Car Park Common Areas are for the purpose of identification only shown and coloured Green on the plans (certified as to their accuracy by the Authorized Person (as defined in the DMC)) annexed to the DMC.

**“Car Park Common Facilities”** means those facilities and equipment for the common use and benefit of the Car Parks, the Visitors' Car Parks and the Accessible Car Parks but not other parts of the Development and not for the use and benefit of a particular Car Park exclusively and shall include but not limited to Common EV Facilities, the relevant installations and facilities for supply of electricity to the Car Parks, the Visitors' Car Parks and the Accessible Car Parks, electrical and mechanical installation, plant and machinery, drainage and sump pump system, mechanical ventilation system and security system.

**“Development Common Areas”** means the whole of the Lot and the Development which are not otherwise specifically assigned to or for the exclusive use of an Owner and are designed or intended for common use and benefit of the Owners (which do not form part of the Units, Residential Common Areas or Car Park Common Areas) and shall include but not limited to CLP cable pits, CLP maintenance accesses, the Pedestrian Walkway, driveways and ramps (which do not form part of the Car Park Common Areas or Residential Common Areas)), civil drains, manholes, part of the emergency vehicular access (which do not form part of the Residential Common Areas), boundary/fence walls, part of the Slope and Retaining Structures (which do not form part of the Residential Common Areas), telecommunications and broadcasting equipment rooms (which do not form part of the Residential Common Areas), mobile equipment room, master water meter rooms, sprinkler water tank and pump rooms (which do not form part of the Residential Common Areas), fire services water tank and pump rooms (which do not form part of the Residential Common Areas), potable water tank and pump rooms (which do not form part of the Residential Common Areas), flushing water tank and pump rooms (which do not form part of the Residential Common Areas), potable and flushing water tank and pump rooms (which do not form part of the Residential Common Areas), water meter cabinets (which do not form part of the Residential Common Areas), staircases (which do not form part of the Units, Car Park Common Areas or Residential Common Areas), caretaker's offices,

street fire hydrant tank and pump rooms, street fire hydrant transfer tank and pump rooms, pipe ducts (which do not form part of the Residential Common Areas), smoke lobbies (which do not form part of the Car Park Common Areas or Residential Common Areas), service corridor (which do not form part of the Residential Common Areas), switch rooms, basement screen walls, cavity wall(s) (which do not form part of the Car Park Common Areas or Residential Common Areas), footpaths and passageways, common flat roofs (which do not form part of the Residential Common Areas), guard room(s), transformer rooms, transformer room lobby, ventilation duct for transformer room, cable riser room, electrical ducts (which do not form part of the Residential Common Areas), fire control centre, cabinets for fire services inlets and valves (which do not form part of the Residential Common Areas), refuse storage and material recovery chambers, generator rooms and all other common parts specified in Schedule 1 to the Ordinance (if any) within the Lot and the Development designed or intended for common use and benefit of the Owners and not otherwise specifically assigned to or for the exclusive use of an Owner (which do not form part of the Units, Residential Common Areas and Car Park Common Areas). The Development Common Areas are for the purpose of identification only shown and coloured Yellow on the plans (certified as to their accuracy by the Authorized Person) annexed to the DMC.

**“Development Common Facilities” means**

- (a) Such of the mobile maintenance unit, drop gate, surface channel with cover, road gullies, drains, pipes, gutters, wells (if any), sewers, wires and cables, aerial broadcast distribution facilities, telecommunications network facilities, electrical and mechanical installation servicing the Development Common Areas and other services facilities whether ducted or otherwise which are or at any time may be in, under or over or passing through the Lot and the Development through which water, sewage, gas, electricity and any other services are supplied to the Lot and the Development or any part or parts thereof which are for the use and benefit of the Lot and the Development and not for the use or benefit of a particular Unit exclusively;
- (b) lighting facilities including lamp posts, façade lighting within the Development which are for the use and benefit of the Lot and the Development and not for the use or benefit of a particular Unit exclusively;
- (c) fire prevention and fire fighting installations and equipment within the Development which are for the use and benefit of the Lot and the Development and not for the use or benefit of a particular Unit exclusively (including the fire services water tank, sprinkler water tank and street fire hydrant water tank);
- (d) security system installations and equipment which are for the use and benefit of the Lot and the Development and not for the use or benefit of a particular Unit exclusively;

and other facilities and ancillary equipment for the common use and benefit of the Lot and the Development and not for the use or benefit of a particular Unit exclusively.

For avoidance of doubt, the term “Development Common Facilities” shall not include those facilities, equipment and other like structures forming part of the Residential Common Facilities or Car Park Common Facilities.

“**Residential Common Areas**” means those parts of the Lot and the Development designed or intended for the common use and benefit of the Owners of the Residential Units (as defined in the DMC) and not otherwise specifically assigned to or for the exclusive use of an Owner of a Residential Unit and shall include but not limited to :-

- (a) the External Walls;
- (b) fence walls of the Units on 3<sup>rd</sup> Floor of Tower 1 (1A & 1B), 3<sup>rd</sup> Floor of Tower 2, 3<sup>rd</sup> Floor and 5<sup>th</sup> Floor of Tower 3 and 3<sup>rd</sup> Floor, 5<sup>th</sup> Floor, 6<sup>th</sup> Floor, 7<sup>th</sup> Floor and 9<sup>th</sup> Floor of Tower 5 (5A & 5B) (excluding the glass balustrade/glazing (if any) or the interior surface of such fence walls facing a Unit or Units);
- (c) Noise Mitigation Measures (excluding those forming part or parts of a Residential Unit);
- (d) cavity wall(s) (which do not form part of the Car Park Common Areas or Development Common Areas), horizontal screen, rainwater harvesting water tank & pump and irrigation water tank & pump room, water play area, communal aerial broadcast distribution equipment rooms, terrace garden deck, driveways and ramps (which do not form part of the Car Park Common Areas or Development Common Areas), architectural fins, lift lobbies, residential shuttle lift lobby, car park lift lobbies, lift shafts, lift pits, lift overruns, lift pit access room, corridors, potable water tank and pump rooms (which do not form part of the Development Common Areas), flushing water tank and pump rooms (which do not form part of the Development Common Areas), potable and flushing water tank and pump rooms (which do not form part of the Development Common Areas), sprinkler water tank and pump rooms (which do not form part of the Development Common Areas), sprinkler transfer water tank and pump rooms, fire services water tank and pump room (which do not form part of the Development Common Areas), staircases (which do not form part of the Units, Car Park Common Areas or Development Common Areas) and landings, access and working spaces, water meter cabinets (which do not form part of the Development Common Areas), telecom cabinets, telecommunications and broadcasting equipment rooms (which do not form part of the Development Common Areas), electric meter rooms, electric ducts, gas cabinets, cabinets for fire services inlets and valves (which do not form part of the Development Common Areas), hose reel cabinets, pipe ducts (which do not form part of the Development Common Areas), electrical ducts (which do not form part of the Development Common Areas), pipe wells, dog houses, refuse storage and material recovery rooms, PRV rooms, gas valve control cabinet, fresh air ducts, exhaust air ducts, areas where the building maintenance unit for maintenance of external drainpipes are located, designated common area for maintenance, lift machine rooms, filtration plant room, planters, lawns, landscaped areas, covered landscaped areas, covered landscaped and play areas, open hard paved area, hard paved landscaped areas, vertical green walls, water features, foot paths and passageways, part of the emergency vehicular access (which do not form part of the Development Common Areas), fireman lift lobbies, smoke lobbies (which do not form part of the Car Park Common Areas or Development Common Areas), service corridors (which do not form part of the Development Common Areas), fan rooms (which do not form part of the Car Park Common Areas), common flat roofs (which do not form part of the Development Common Areas), inaccessible common flat roofs, covers of balconies / utility platforms / air conditioning platforms, and common roofs;

- (e) the Greenery Areas, part of the Slope and Retaining Structures (which do not form part of the Development Common Areas), the Recreational Areas, lift lobbies within the Recreational Areas and the Recreational Facilities, the Accessible Car Parks, the Visitors' Car Parks, the Bicycle Parking Spaces and the loading and unloading spaces provided pursuant to Special Condition No.(25)(a) of the Government Grant (as defined in the DMC);

and all other common parts specified in Schedule 1 to the Ordinance (if any) within the Lot and the Development designed or intended for the common use and benefit of the Owners of the Residential Units and not otherwise specifically assigned to or for the exclusive use of an Owner of a Residential Unit. The Residential Common Areas are for the purpose of identification only shown and coloured Red, Red Hatched Black and Red Stippled Black on the plans (certified as to their accuracy by the Authorized Person) annexed to the DMC.

“**Residential Common Facilities**” means those facilities and ancillary equipment for the common use and benefit of the Owners of the Residential Units and not for the use and benefit of a particular Residential Unit exclusively and shall include but not limited to the Recreational Facilities, installation or facilities for the supply of electricity to the Accessible Car Parks and the Visitors' Car Parks, aerial broadcast distribution or telecommunication network facilities and other transmission devices and equipment, water tanks, water pumps, drains, pipes, gutters, sewers, fire prevention and firefighting system, wires and cables, electrical equipment, air-conditioning or mechanical ventilation installation, lighting, security system, mobilized building maintenance unit, gas pipes, air-conditioning system, telecommunications network facilities, lifts and sanitary fittings and installations for the use and benefit of the Residential Units.

“**Accessible Car Park**” or “**Accessible Car Parks**” means the 3 parking spaces on Ground Floor for the parking of motor vehicles by disabled persons provided in the Lot and the Development pursuant to Special Condition No.(24)(b)(i) of the Government Grant and shown on the Ground Floor Plan (certified as to their accuracy by the Authorized Person) annexed to the DMC and thereon marked “ACC. CARPARK” for the purpose of identification only.

“**Bicycle Parking Spaces**” means the 42 bicycle parking spaces on 1<sup>st</sup> Floor provided pursuant to Special Condition No.(26) of the Government Grant for the parking of bicycles and shown on the First Floor Plan (certified as to its accuracy by the Authorized Person) annexed to the DMC and thereon coloured Red and marked “B1” to “B42” for the purpose of identification only.

“**Common EV Facilities**” means such facilities installed or to be installed within the Car Park Common Areas for the common use and benefit of the Car Parks, the Visitors' Car Parks and the loading and unloading spaces for the purpose of or in relation to the charging of electric motor vehicles licensed under the Road Traffic Ordinance (Cap.374) parking at any of the Car Parks, the Visitors' Car Parks and the loading and unloading spaces; such facilities shall not serve any of the Car Parks, the Visitors' Car Parks and the loading and unloading spaces exclusively or belong to any of the Owner of the Car Parks and shall include but not limited to such apparatus, cables, ducts, equipment, trunking, wires and such other electrical or other installations or otherwise for or in relation to such purpose. Location(s) of the Common EV Facilities are shown on the Approved Plans (as defined in the DMC), a copy of which will be deposited at the caretaker's offices in the Development for inspection by the Owners during normal office hours free of costs and charges.

**“External Walls”** means the external walls of the Development or any part thereof including but not limited to curtain walls (including the cast-in anchors, gasket, glass panels, window frames, window sealant and such other components of the curtain wall, the non-openable windows therein or thereto and cast-in anchors, gasket, glass panels, window frames, window sealant and such other components of such non-openable windows but excluding all openable windows installed therein and the cast-in anchors, frames enclosing the glass panels of the openable windows, gasket, glass panels, handles, hinges, locks, window sealant and such other components of such openable windows), non-structural prefabricated external walls (which are for the purpose of identification only shown and marked in Lime Dashed Lines (“LDL”) on the plans (certified as to their accuracy by the Authorized Person) annexed to the DMC), fixed glazing, architectural features, parapet walls (other than those between Units) and the windows and window frames of the Common Areas but excluding the internal surface of the concrete walls facing the Units, the parapets/balustrades/fence walls of the gardens, flat roofs, roofs and Non-enclosed Area (as defined in the DMC) pertaining to the respective Units or their replacement, the sliding/swing door to the gardens, flat roofs, roofs and Non-enclosed Area, and the windows/openable windows/maintenance windows (other than those non-openable windows installed in or to curtain wall), window frames and sealant around window frames of the Units.

**“Greenery Areas”** means those areas of the Lot provided pursuant to Special Condition No.(10)(c) of the Government Grant, which are for the purpose of identification only shown and coloured Red Stippled Black on the Greenery Area Plan (certified as to their accuracy by the Authorized Person) annexed to the DMC.

**“Noise Mitigation Measures”** means all or any of the noise mitigation measures approved by the Director of Environmental Protection provided within the Development and any subsequent amendments thereto (if any) approved by the Director of Environmental Protection including acoustic sliding doors, acoustic windows, enhanced acoustic sliding doors, enhanced acoustic windows, fixed glazing, metal claddings/features with sound absorptive material, min. 1.1m high above finish floor solid parapets, self-closing swing doors, ventilation windows and, for the purpose of identification only, as shown on the plans annexed to the DMC.

**“Pedestrian Walkway”** means the pedestrian walkway as referred to in Special Condition (41)(b)(i) of the Government Grant.

**“Recreational Areas”** means the areas intended for recreational use by the residents of the Residential Units and their bona fide visitors which shall include but not limited to lifts, lift lobbies, staircases, planters, covered landscaped areas, covered landscaped and play areas, library, water play area, children’s play room, sauna, footbath, game rooms, seating area, jacuzzi, cabana, swimming pool, kid’s pool, pool decks, wet pool decks, lavatories, accessible lavatories, function rooms, gymnasium, changing rooms, filtration plant room, stores, concierge and ball court.

**“Recreational Facilities”** means the recreational facilities and facilities ancillary thereto provided or installed for recreational use by the residents of the Residential Units and their bona fide visitors pursuant to Special Condition No.(13)(a) of the Government Grant.

**“Slope and Retaining Structures”** means all slopes, slope treatment works, retaining walls and other structures within or outside the Lot, the maintenance of which is the liability of the Owners under the Government Grant and/or the DMC, which are for the purpose of identification only shown and coloured Yellow with Black Broken Lines, Red with Black Broken Lines and Orange on the Slope and Retaining Structures Plans (certified as to its accuracy by the Authorized Person) annexed to the DMC.

**“Visitors’ Car Park”** or **“Visitors’ Car Parks”** means the 21 car parking spaces on Ground Floor provided pursuant to Special Condition No.(24)(a)(iii) of the Government Grant (including the 3 Accessible Car Parks) and shown on the Ground Floor Plan (certified as to their accuracy by the Authorized Person) annexed to the DMC and thereon coloured Red for the purpose of identification only.

#### B. The number of undivided shares assigned to each residential property in the Phase

Floor	Unit	No. of Undivided Shares allocated to each Residential Unit
Tower 3		
3/F	B <sup>e</sup>	40
	C <sup>e</sup>	37
	D <sup>e</sup>	40
	E <sup>e</sup>	36
	F <sup>e</sup>	35
	G <sup>e,f</sup>	43
	H <sup>e</sup>	28
	J <sup>e</sup>	27
	K <sup>e</sup>	27
5/F	A <sup>e,f</sup>	61
	B <sup>a,b,c</sup>	42
	C <sup>a,b,c</sup>	39
	D <sup>a,b,c</sup>	42
	E <sup>a,b,c</sup>	38
	F <sup>a,b,c</sup>	37
	G <sup>a,b,c</sup>	43
	H <sup>a,b,c</sup>	29
	J <sup>a,b,c</sup>	28
	K <sup>a,b,c</sup>	28
	M <sup>a,b,c,e</sup>	29
N <sup>a,b,c,e</sup>	31	

Floor	Unit	No. of Undivided Shares allocated to each Residential Unit
Tower 3		
6/F - 12/F, 15/F - 23/F & 25/F	A <sup>a,b,c</sup>	61
	B <sup>a,b,c</sup>	42
	C <sup>a,b,c</sup>	39
	D <sup>a,b,c</sup>	42
	E <sup>a,b,c</sup>	38
	F <sup>a,b,c</sup>	37
	G <sup>a,b,c</sup>	43
	H <sup>a,b,c</sup>	29
	J <sup>a,b,c</sup>	28
	K <sup>a,b,c</sup>	28
	M <sup>a,b,c</sup>	28
N <sup>a,b,c</sup>	29	
26/F	A <sup>a,b,c,g</sup>	66
	B <sup>a,b,c,g</sup>	46
	C <sup>a,b,c,g</sup>	42
	D <sup>a,b,c,g</sup>	44
	E <sup>a,b,c,g</sup>	42
	F <sup>a,b,c,g</sup>	41
	G <sup>a,b,c,g</sup>	47
	H <sup>a,b,c,g</sup>	31
	J <sup>a,b,c,g</sup>	31
	K <sup>a,b,c,g</sup>	31
	M <sup>a,b,c,g</sup>	31
N <sup>a,b,c,g</sup>	31	

Floor	Unit	No. of Undivided Shares allocated to each Residential Unit
Tower 5 (5A)		
3/F	A <sup>e</sup>	45
	B <sup>e,f</sup>	39
	C <sup>e,f</sup>	69
	D <sup>e</sup>	39
	E <sup>e</sup>	39
	F <sup>e</sup>	30
	G <sup>e</sup>	30
	M <sup>e</sup>	19
	N <sup>e</sup>	21
	P <sup>e</sup>	27
	Q <sup>e</sup>	27
5/F	A <sup>a,b,c</sup>	48
	B <sup>a,b,c</sup>	41
	C <sup>a,b,c</sup>	71
	D <sup>a,b,c</sup>	41
	E <sup>a,b,c</sup>	41
	F <sup>a,b,c</sup>	33
	G <sup>a,b,c</sup>	33
	J <sup>e</sup>	26
	K <sup>e</sup>	18
	M <sup>a,c</sup>	19
	N <sup>a,c</sup>	22
P <sup>a,b,c</sup>	30	
Q <sup>a,b,c</sup>	29	
R <sup>a,b,c</sup>	31	

Floor	Unit	No. of Undivided Shares allocated to each Residential Unit
Tower 5 (5A)		
6/F	A <sup>a,b,c</sup>	48
	B <sup>a,b,c</sup>	41
	C <sup>a,b,c</sup>	71
	D <sup>a,b,c</sup>	41
	E <sup>a,b,c</sup>	41
	F <sup>a,b,c</sup>	33
	G <sup>a,b,c</sup>	33
	H <sup>e</sup>	26
	J <sup>a,b,c</sup>	28
	K <sup>a,c</sup>	19
	M <sup>a,c</sup>	19
	N <sup>a,c</sup>	22
	P <sup>a,b,c</sup>	30
7/F	Q <sup>a,b,c</sup>	29
	R <sup>a,b,c</sup>	31
	A <sup>a,b,c</sup>	48
	B <sup>a,b,c</sup>	41
	C <sup>a,b,c</sup>	71
	D <sup>a,b,c</sup>	41
	E <sup>a,b,c</sup>	41
	F <sup>a,b,c</sup>	33
	G <sup>a,b,c</sup>	33
	H <sup>a,b,c</sup>	28
	J <sup>a,b,c</sup>	28
	K <sup>a,c</sup>	19
	M <sup>a,c</sup>	19
N <sup>a,c</sup>	22	
P <sup>a,b,c</sup>	30	

Floor	Unit	No. of Undivided Shares allocated to each Residential Unit
Tower 5 (5A)		
8/F	A <sup>a,b,c</sup>	48
	B <sup>a,b,c</sup>	41
	C <sup>a,b,c</sup>	71
	D <sup>a,b,c</sup>	41
	E <sup>a,b,c</sup>	41
	F <sup>a,b,c</sup>	33
	G <sup>a,b,c</sup>	33
	H <sup>a,b,c</sup>	28
	J <sup>a,b,c</sup>	28
	K <sup>a,c</sup>	19
	M <sup>a,c</sup>	19
	N <sup>a,c</sup>	22
	P <sup>a,b,c</sup>	30
9/F	A <sup>a,b,c</sup>	48
	B <sup>a,b,c</sup>	41
	C <sup>a,b,c</sup>	71
	D <sup>a,b,c</sup>	41
	E <sup>a,b,c</sup>	41
	F <sup>a,b,c</sup>	33
	G <sup>a,b,c</sup>	33
	H <sup>a,b,c</sup>	28
	J <sup>a,b,c</sup>	28
	K <sup>a,c</sup>	19
	M <sup>a,c</sup>	19
	N <sup>a,c</sup>	22
	P <sup>a,b,c</sup>	30



Floor	Unit	No. of Undivided Shares allocated to each Residential Unit
Tower 5 (5A)		
10/F - 12/F, 15/F - 23/F & 25/F	A <sup>a,b,c</sup>	48
	B <sup>a,b,c</sup>	41
	C <sup>a,b,c</sup>	71
	D <sup>a,b,c</sup>	41
	E <sup>a,b,c</sup>	41
	F <sup>a,b,c</sup>	33
	G <sup>a,b,c</sup>	33
	H <sup>a,b,c</sup>	28
	J <sup>a,b,c</sup>	28
	K <sup>a,c</sup>	19
	M <sup>a,c</sup>	19
	N <sup>a,c</sup>	22
P <sup>a,b,c</sup>	30	
26/F	A <sup>a,b,c,g</sup>	52
	B <sup>a,b,c,g</sup>	45
	C <sup>a,b,c,g</sup>	77
	D <sup>a,b,c,g</sup>	45
	E <sup>a,b,c,g</sup>	44
	F <sup>a,b,c,g</sup>	35
	G <sup>a,b,c,g</sup>	36
	H <sup>a,b,c,g</sup>	29
	J <sup>a,b,c,g</sup>	29
	K <sup>a,c,g</sup>	20
	M <sup>a,c,g</sup>	21
	N <sup>a,c,g</sup>	24
P <sup>a,b,c,g</sup>	32	

Floor	Unit	No. of Undivided Shares allocated to each Residential Unit
Tower 5 (5B)		
7/F	A <sup>a,b,c</sup>	29
	B <sup>a,b,c</sup>	29
	C <sup>a,c</sup>	22
	J <sup>e</sup>	19
	K <sup>e</sup>	18
	M <sup>a,b,c</sup>	30
	N <sup>e</sup>	26
8/F	A <sup>a,b,c</sup>	29
	B <sup>a,b,c</sup>	29
	C <sup>a,c</sup>	22
	J <sup>a,c</sup>	20
	K <sup>a,c</sup>	19
	M <sup>a,b,c</sup>	30
	N <sup>a,b,c</sup>	29
9/F	A <sup>a,b,c</sup>	29
	B <sup>a,b,c</sup>	29
	C <sup>a,c</sup>	21
	D <sup>e</sup>	19
	E <sup>e</sup>	19
	F <sup>a,b,c,e</sup>	32
	G <sup>e</sup>	29
	H <sup>e</sup>	18
	J <sup>a,c</sup>	19
	K <sup>a,c</sup>	19
	M <sup>a,b,c</sup>	30
	N <sup>a,b,c</sup>	29

Floor	Unit	No. of Undivided Shares allocated to each Residential Unit
Tower 5 (5B)		
10/F - 12/F, 15/F - 23/F & 25/F	A <sup>a,b,c</sup>	29
	B <sup>a,b,c</sup>	29
	C <sup>a,c</sup>	21
	D <sup>a,c</sup>	21
	E <sup>a,c</sup>	21
	F <sup>a,b,c</sup>	29
	G <sup>a,b,c</sup>	31
	H <sup>a,c</sup>	19
	J <sup>a,c</sup>	19
	K <sup>a,c</sup>	19
	M <sup>a,b,c</sup>	30
	N <sup>a,b,c</sup>	29

Floor	Unit	No. of Undivided Shares allocated to each Residential Unit
Tower 5 (5B)		
26/F	A <sup>a,b,c,g</sup>	31
	B <sup>a,b,c,g</sup>	32
	C <sup>a,c,g</sup>	22
	D <sup>a,c,g</sup>	22
	E <sup>a,c,g</sup>	22
	F <sup>a,b,c,g</sup>	31
	G <sup>a,b,c,g</sup>	33
	H <sup>a,c,g</sup>	21
	J <sup>a,c</sup>	19
	K <sup>a,c</sup>	19
	M <sup>a,b,c,g</sup>	31
	N <sup>a,b,c,g</sup>	31

## Notes :-

1. There is no designation of 4/F, 13/F, 14/F and 24/F for all Towers.
2. There is no designation of Tower 4.
3. <sup>a</sup> denotes Residential Unit with balcony.
4. <sup>b</sup> denotes Residential Unit with utility platform.
5. <sup>c</sup> denotes Residential Unit with air-conditioning platform(s).
6. <sup>d</sup> denotes Residential Unit with air-conditioning plant room.
7. <sup>e</sup> denotes Residential Unit with flat roof(s).
8. <sup>f</sup> denotes Residential Unit with garden.
9. <sup>g</sup> denotes Residential Unit with roof.

**C. The term of years for which the manager of the Phase is appointed**

Subject to the provisions of the Building Management Ordinance (Cap.344), the appointment of the Management Company (as defined in the DMC) as the Manager (as defined in the DMC) of the Lot and the Development shall be for an initial period of two (2) years from the date of the DMC and shall continue thereafter until termination of the appointment in accordance with the provisions of the DMC.

**D. The basis on which the management expenses are shared among the owners of the residential properties in the Phase**

1. Where any expenditure relates to or is for the benefit of the Lot and the Development (but does not relate solely to or is not solely for the benefit of any Unit, Residential Common Areas, Car Park Common Areas, Residential Common Facilities or Car Park Common Facilities), the Development Common Areas and/or the Development Common Facilities the full amount of such expenditure shall be apportioned between all the Owners of the Development in proportion to the number of Management Shares (as defined in the DMC) held by them.
2. Where any expenditure relates solely to or is solely for the benefit of the Residential Units (but does not relate solely to or is not solely for the benefit of any particular Residential Unit), the Residential Common Areas and/or the Residential Common Facilities the full amount of such expenditure shall be apportioned between the Owners of the Residential Units in proportion to the number of Management Shares held by them.
3. Where any expenditure relates solely to or is solely for the benefit of the Car Parks (but does not relate solely to or is not solely for the benefit of any particular Car Park), the Car Park Common Areas and/or the Car Park Common Facilities, a proportion of the expenditure relating to the Car Park Common Areas and/or the Car Park Common Facilities equivalent to a proportion of the total gross floor areas of the Visitors' Car Parks (including the Accessible Car Parks) forming parts of the Residential Common Areas bear to the total gross floor areas of the Car Parks and the Visitors' Car Parks (including the Accessible Car Parks) shall be borne by the Owners of the Residential Units in proportion to the number of Management Shares held by them.
4. Where any expenditure relates solely to or is solely for the benefit of a Unit, the full amount of such expenditure shall be borne by the Owner of such Unit.

**E. The basis on which the management fee deposit is fixed**

The management fee deposit payable in respect of each Residential Unit shall be equivalent to three (3) months' Management Fee for that Residential Unit.

**F. The area (if any) in the Phase retained by the Owner for that Owner's own use**

Not applicable.

**A. 期數的公用部份**

「**公用地方**」指發展項目公用地方、住宅公用地方及停車場公用地方。

「**公用設施**」指發展項目公用設施、住宅公用設施及停車場公用設施。

「**停車場公用地方**」指在該地段(定義見公契)及發展項目(定義見公契)內設計或擬供停車位(定義見公契)業主(定義見公契)和訪客停車位及暢通易達停車位佔用人公用及共享,而非特別轉讓給或供個別停車位業主獨家使用的該地段及發展項目的該等部份(不包括在建築事務監督批准的停車場佈局圖上顯示和劃定的該等停車位),及《建築物管理條例》(第344章)附表1所指明的所有其他公用部份(如有),包括但不限於停車場穿梭升降機大堂、車道及坡道(不構成住宅公用地方一部份者)、下斜路緣石、通道區、循環通道、風機房(不構成住宅公用地方一部份者)、特低電壓房、電房、電錶房、通風管槽、排煙口、防煙大堂(不構成發展項目公用地方或住宅公用地方一部份者)、空心牆(不構成發展項目公用地方或住宅公用地方一部份者)、出口走廊和樓梯(不構成單位(定義見公契)、發展項目公用地方或住宅公用地方一部份者)。停車場公用地方在公契夾附的圖則(經認可人士核證為準確)上以綠色顯示,僅供識別之用。

「**停車場公用設施**」指供停車位、訪客停車位及暢通易達停車位(而非發展項目的其他部份)公用及共享,而非供個別停車位獨家使用及享用的該等設施和設備,包括但不限於公用電動車充電設施、為停車位、訪客停車位及暢通易達停車位供電的相關裝置及設施、電力及機械裝置、機械及機器、排水及污水泵系統、機械通風系統及保安系統。

「**發展項目公用地方**」指設計或擬供業主公用及共享,而非特別轉讓給或供個別業主獨家使用的整個該地段及發展項目(不構成單位、住宅公用地方或停車場公用地方一部份者),包括但不限於中電電纜井道、中電維修出入口、行人通道、車道和坡道(不構成停車場公用地方或住宅公用地方一部份者)、民用排水渠、人孔、部份緊急車輛通道(不構成住宅公用地方一部份者)、邊界牆/圍牆、部份斜坡及護土構築物(不構成住宅公用地方一部份者)、電訊及廣播設備室(不構成住宅公用地方一部份者)、流動設備房、主水錶房、花灑轉運水箱和泵房(不構成住宅公用地方一部份者)、消防水箱和泵房(不構成住宅公用地方一部份者)、食水水箱和泵房(不構成住宅公用地方一部份者)、沖廁水箱和泵房(不構成住宅公用地方一部份者)、食水和沖廁水箱和泵房(不構成住宅公用地方一部份者)、水錶櫃(不構成住宅公用地方一部份者)、樓梯(不構成單位、停車場公用地方或住宅公用地方一部份者)、管理員辦公室、街道消防栓水箱和泵房、街道消防栓轉運水箱和泵房、管道槽(不構成住宅公用地方一部份者)、防煙大堂(不構成停車場公用地方或住宅公用地方一部份者)、服務走廊(不構成住宅公用地方一部份者)、掣房、地庫分隔牆、空心牆(不構成停車場公用地方或住宅公用地方一部份者)、人行道和通道、公用平台(不構成住宅公用地方一部份者)、警衛室、變壓器房、變壓器房大堂、變壓器房通風管道、電纜豎管房、電槽(不構成住宅公用地方一部份者)、消防控制中心、消防入水口及閘櫃(不構成住宅公用地方一部份者)、垃圾儲存及物料回收室、發電機房以及在《建築物管理條例》(第344章)附表1指明的設計或擬供業主公用及共享而非特別轉讓給或供個別業主獨家使用的所有其他公用部份(如有)(不構成單位、住宅公用地方或停車場公用地方一部份者)。發展項目公用地方在公契夾附的圖則(經認可人士核證為準確)上以黃色顯示,僅供識別之用。

「**發展項目公用設施**」指

- (a) 服務發展項目公用地方的該等流動維修裝置、吊閘、地面溝渠連蓋、道路明渠、排水渠、管道、水溝、井(如有)、污水渠、電線及電纜、天線廣播分導設施、電訊網絡設施、電力及機械裝置,和目前或任何時候在該地段及發展項目內、下、上或穿過該地段及發展項目而將水、污水、氣體、電力和任何其他服務提供給該地段及發展項目或其任何一個或多個部份,並供該地段及發展項目使用及享用而非供個別單位獨家使用或享用的其他服務設施(不論是否套上套管);

- (b) 發展項目內供該地段及發展項目使用及享用而非供個別單位獨家使用或享用的照明設施,包括燈柱、立面照明;

- (c) 發展項目內供該地段及發展項目使用及享用而非供個別單位獨家使用或享用的防火及滅火裝置及設備(包括消防水箱、花灑水箱及街道消防栓水箱);

- (d) 供該地段及發展項目使用及享用而非供個別單位獨家使用或享用的保安系統裝置及設備;

和供該地段及發展項目公用及共享而非供個別單位獨家使用或享用的其他設施及輔助設備。

為免存疑,「發展項目公用設施」一詞不包括構成住宅公用設施或停車場公用設施一部份的該等設施、設備及其他類似構築物。

「**住宅公用地方**」指設計或擬供發展項目的住宅單位業主公用及共享,而非特別轉讓給或供個別住宅單位業主獨家使用的該地段及發展項目的該等部份,包括但不限於:

- (a) 外牆;

- (b) 第1座(1A及1B)3樓、第2座3樓、第3座3樓及5樓及第5座(5A及5B)3樓、5樓、6樓、7樓及9樓單位的圍牆(不包括玻璃欄桿/玻璃窗(如有)或面向一個或多個單位的圍牆的內面);

- (c) 「噪音緩解措施」(不包括構成住宅單位一部份者);

- (d) 空心牆(不構成停車場公用地方或發展項目公用地方一部份者)、橫向屏障、雨水收集水箱及水泵及灌溉水箱及水泵房、戲水區、公用天線廣播分配設備房、前庭花園平台、車道和坡道(不構成停車場公用地方或發展項目公用地方一部份者)、建築鱗片、電梯大堂、住宅穿梭升降機大堂、停車場升降機大堂、升降機井、升降機槽、升降機淨空位置、升降機井通道房、走廊、食水水箱及泵房(不構成發展項目公用地方一部份者)、沖廁水箱及泵房(不構成發展項目公用地方一部份者)、食水及沖廁水箱及泵房(不構成發展項目公用地方一部份者)、花灑水箱及泵房(不構成發展項目公用地方一部份者)、花灑轉運水箱及泵房、消防水箱及泵房(不構成發展項目公用地方一部份者)、樓梯(不構成單位、停車場公用地方或發展項目公用地方一部份者)和樓梯平台、通道和工作空間、水錶櫃(不構成發展項目公用地方一部份者)、電訊機櫃、電訊及廣播設備室(不構成發展項目公用地方一部份者)、電錶房、電槽、煤氣櫃、消防入水口及閘櫃(不構成發展項目公用地方一部份者)、消防喉轆櫃、管道槽(不構成發展項目公用地方一部份者)、電力槽(不構成發展項目公用地方一部份者)、管道井、室外管道房、垃圾儲存及物料回收間房、減壓閘房、煤氣閘控制櫃、鮮風管、排風管、維護外部排水管的建築維護單位所在區域、維修用指定公用地方、升降機機房、過濾機房、花槽、草坪、園景地方、有蓋園景地方、有蓋園景和遊樂地方、開放地方硬鋪區域、硬鋪園景地方、垂直綠化牆、水景、人行道和通道、部份緊急車輛通道(不構成發展項目公用地方一部份者)、消防員升降機大堂、防煙大堂(不構成停車場公用地方或發展項目公用地方一部份者)、服務走廊(不構成發展項目公用地方一部份者)、風機房(不構成停車場公用地方一部份者)、公用平台(不構成發展項目公用地方一部份者)、不能進入的公用平台、露台/工作平台/冷氣機平台的頂蓋,及公用天台;

- (e) 綠化範圍、部份斜坡及護土構築物(不構成發展項目公用地方一部份者)、康樂範圍、康樂範圍內的升降機大堂及康樂設施、暢通易達停車位、訪客停車位、單車停車位以及根據批地文件特別條款第(25)(a)條提供的上落貨車位(定義見公契);

以及在《建築物管理條例》(第344章)附表1指明的設計或擬供住宅單位業主公用及共享而非特別轉讓給或供個別住宅單位業主獨家使用的所有其他公用部份(如有)。住宅公用地方在公契夾附的圖則(經認可人士核證為準確)上以紅色、紅色間黑斜綫及紅色加黑點顯示,僅供識別之用。

「住宅公用設施」指供住宅單位業主公用及共享而非供個別住宅單位獨家使用的該等設施及輔助設備，包括但不限於康樂設施、為暢通易達停車位及訪客停車位供電的裝置或設施、天線廣播分導或電訊網絡設施，及其他供住宅單位業主使用及共用的傳輸裝置和設備、水箱、水泵、排水渠、管道、水溝、污水渠、防火和滅火系統、電線和電纜、電力設備、空調或機械通風裝置、照明、保安系統、機動建築維護單位、煤氣管道、空調系統、電訊網絡設施、電梯和衛生設備及裝置。

「暢通易達停車位」指根據批地文件特別條款第(24)(b)(i)條在該地段和發展項目中提供位於地下的3個供殘疾人士停泊車輛停車位，其在公契夾附的地下圖則(經認可人士核證為準)顯示並標以「ACC. CARPARK」，僅供識別之用。

「單車停車位」指根據批地文件特別條款第(26)條在一樓提供的42個單車停車位，其在公契夾附的一樓圖則(經認可人士核證為準)以紅色顯示並標以「B1」至「B42」，僅供識別之用。

「公用電動車充電設施」指在停車場公用地方內安裝或將安裝，供停車位、訪客停車位和上落貨車位公用及共享的該等設施，其旨在或關乎供停泊在任何停車位、訪客停車位和上落貨車位的按《道路交通條例》(第374章)獲發牌的電動車輛充電；該等設施並非專門服務任何停車位、訪客停車位和上落貨車位亦非屬於任何停車位的業主，並包括但不限於用於上述目的或與其相關的裝置、電纜、槽道、設備、線槽、電線和其他該等電力或其他裝置或其他項件。公用電動車充電設施的位置已在經批准圖則(定義見公契)中顯示，其副本將存放於發展項目的管理員辦公室，供業主在正常辦公時間內免費查閱。

「外牆」指發展項目的外牆或其任何部份，包括但不限於幕牆(包括預埋錨栓、墊片、玻璃板、窗框、窗戶密封膠及幕牆的其他組件、在其中或其上的不可開啟窗戶或以及該等不可開啟窗戶的預埋錨栓、墊片、玻璃板、窗框、窗戶密封膠和該等其他組件，但不包括安裝在其中的所有可開啟窗戶以及該等可開啟窗戶的錨栓、圍著可開啟窗戶玻璃板的框、墊片、玻璃板、把手、鉸鏈、鎖、窗戶密封膠和該等可開啟窗戶的該等其他組件)、非結構預製外牆(在公契夾附的圖則(經認可人士核證為準)以檸檬青色虛線顯示並標以「LDL」，僅供識別之用)、固定玻璃窗、建築裝飾、護牆(單位之間的護牆除外)以及公用地方的窗戶及窗框，但不包括對著單位一邊的混凝土牆的內面、花園的護牆/欄桿/圍牆、屬於各別單位的平台、天台及非圍封範圍(定義見公契)或其替代、花園、平台、天台及非圍封範圍的趟門/掩門，以及單位的窗戶/可開啟窗戶/維修窗戶(該等安裝於幕牆或其中的不可開啟窗戶除外)、窗框及窗框周圍的窗戶密封膠。

「綠化範圍」指根據批地文件特別條款第(10)(c)條在該地段內提供的範圍，其在公契夾附的綠化範圍圖則(經認可人士核證為準)以紅色加黑點顯示，僅供識別之用。

「噪音緩解措施」指發展項目內設置的所有或任何經環保署署長批准的噪音緩解措施及其後經環保署署長批准的任何修訂(如有)，包括減音趟門、減音窗戶、強化減音趟門、強化減音窗戶、固定玻璃、金屬包層/裝飾連吸音物料、最少高出地板飾面1.1米的實心護牆、自動關閉掩門和通風窗，其在公契夾附的圖則顯示，僅供識別之用。

「行人通道」指批地文件特別條款第(41)(b)(i)條提及的行人通道。

「康樂範圍」指擬供住宅單位的住戶及其真誠訪客康樂之用的地方，包括但不限於升降機、升降機大堂、樓梯、花槽、有蓋園景地方、有蓋園景和遊樂地方、圖書館、戲水區、兒童遊樂室、桑拿浴室、足浴、遊戲室、休息區、按摩池、池邊小屋、游泳池、兒童游泳池、泳池甲板、濕泳池甲板、洗手間、暢通易達洗手間、多功能房、健身室、更衣室、過濾機房、儲物室、禮賓部和球場。

「康樂設施」指根據批地文件特別條款第(13)(a)條提供或安裝給住宅單位的住戶及其真誠訪客的康樂設施及其輔助設備。

「斜坡及護土構築物」指該地段內或外的所有根據批地文件和/或公契須由業主負責維護的斜坡、斜坡處理工程、護土牆及其他構築物，其在公契夾附的斜坡及護土構築物圖則(經認可人士核證為準)以黃色加黑色虛線、紅色加黑色虛線及橙色顯示，僅供識別之用。

「訪客停車位」指根據批地文件特別條款第(24)(a)(iii)條在地下提供的21個停車位(包括3個暢通易達停車位)，其在公契夾附的地下圖則(經認可人士核證為準)以紅色顯示，僅供識別之用。

#### B. 分配予期數中的每個住宅物業的不分割份數的數目

樓層	單位	分配予每個住宅物業的不分割份數的數目
第 3 座		
3 樓	B <sup>e</sup>	40
	C <sup>e</sup>	37
	D <sup>e</sup>	40
	E <sup>e</sup>	36
	F <sup>e</sup>	35
	G <sup>e,f</sup>	43
	H <sup>e</sup>	28
	J <sup>e</sup>	27
	K <sup>e</sup>	27
5 樓	A <sup>e,f</sup>	61
	B <sup>a,b,c</sup>	42
	C <sup>a,b,c</sup>	39
	D <sup>a,b,c</sup>	42
	E <sup>a,b,c</sup>	38
	F <sup>a,b,c</sup>	37
	G <sup>a,b,c</sup>	43
	H <sup>a,b,c</sup>	29
	J <sup>a,b,c</sup>	28
	K <sup>a,b,c</sup>	28
M <sup>a,b,c,e</sup>	29	
N <sup>a,b,c,e</sup>	31	

樓層	單位	分配予每個住宅物業的不分割份數的數目
第 3 座		
6 樓至 12 樓、 15 樓至 23 樓 及 25 樓	A <sup>a,b,c</sup>	61
	B <sup>a,b,c</sup>	42
	C <sup>a,b,c</sup>	39
	D <sup>a,b,c</sup>	42
	E <sup>a,b,c</sup>	38
	F <sup>a,b,c</sup>	37
	G <sup>a,b,c</sup>	43
	H <sup>a,b,c</sup>	29
	J <sup>a,b,c</sup>	28
	K <sup>a,b,c</sup>	28
	M <sup>a,b,c</sup>	28
N <sup>a,b,c</sup>	29	
26 樓	A <sup>a,b,c,g</sup>	66
	B <sup>a,b,c,g</sup>	46
	C <sup>a,b,c,g</sup>	42
	D <sup>a,b,c,g</sup>	44
	E <sup>a,b,c,g</sup>	42
	F <sup>a,b,c,g</sup>	41
	G <sup>a,b,c,g</sup>	47
	H <sup>a,b,c,g</sup>	31
	J <sup>a,b,c,g</sup>	31
	K <sup>a,b,c,g</sup>	31
	M <sup>a,b,c,g</sup>	31
N <sup>a,b,c,g</sup>	31	

樓層	單位	分配予每個住宅物業的不分割份數的數目
第 5 座 (5A)		
3 樓	A <sup>e</sup>	45
	B <sup>e,f</sup>	39
	C <sup>e,f</sup>	69
	D <sup>e</sup>	39
	E <sup>e</sup>	39
	F <sup>e</sup>	30
	G <sup>e</sup>	30
	M <sup>e</sup>	19
	N <sup>e</sup>	21
	P <sup>e</sup>	27
	Q <sup>e</sup>	27
5 樓	A <sup>a,b,c</sup>	48
	B <sup>a,b,c</sup>	41
	C <sup>a,b,c</sup>	71
	D <sup>a,b,c</sup>	41
	E <sup>a,b,c</sup>	41
	F <sup>a,b,c</sup>	33
	G <sup>a,b,c</sup>	33
	J <sup>e</sup>	26
	K <sup>e</sup>	18
	M <sup>a,c</sup>	19
	N <sup>a,c</sup>	22
P <sup>a,b,c</sup>	30	
Q <sup>a,b,c</sup>	29	
R <sup>a,b,c</sup>	31	

樓層	單位	分配予每個住宅物業的不分割份數的數目
第5座(5A)		
6樓	A <sup>a,b,c</sup>	48
	B <sup>a,b,c</sup>	41
	C <sup>a,b,c</sup>	71
	D <sup>a,b,c</sup>	41
	E <sup>a,b,c</sup>	41
	F <sup>a,b,c</sup>	33
	G <sup>a,b,c</sup>	33
	H <sup>e</sup>	26
	J <sup>a,b,c</sup>	28
	K <sup>a,c</sup>	19
	M <sup>a,c</sup>	19
	N <sup>a,c</sup>	22
	P <sup>a,b,c</sup>	30
	Q <sup>a,b,c</sup>	29
R <sup>a,b,c</sup>	31	
7樓	A <sup>a,b,c</sup>	48
	B <sup>a,b,c</sup>	41
	C <sup>a,b,c</sup>	71
	D <sup>a,b,c</sup>	41
	E <sup>a,b,c</sup>	41
	F <sup>a,b,c</sup>	33
	G <sup>a,b,c</sup>	33
	H <sup>a,b,c</sup>	28
	J <sup>a,b,c</sup>	28
	K <sup>a,c</sup>	19
	M <sup>a,c</sup>	19
	N <sup>a,c</sup>	22
	P <sup>a,b,c</sup>	30

樓層	單位	分配予每個住宅物業的不分割份數的數目
第5座(5A)		
8樓	A <sup>a,b,c</sup>	48
	B <sup>a,b,c</sup>	41
	C <sup>a,b,c</sup>	71
	D <sup>a,b,c</sup>	41
	E <sup>a,b,c</sup>	41
	F <sup>a,b,c</sup>	33
	G <sup>a,b,c</sup>	33
	H <sup>a,b,c</sup>	28
	J <sup>a,b,c</sup>	28
	K <sup>a,c</sup>	19
	M <sup>a,c</sup>	19
	N <sup>a,c</sup>	22
	P <sup>a,b,c</sup>	30
	9樓	A <sup>a,b,c</sup>
B <sup>a,b,c</sup>		41
C <sup>a,b,c</sup>		71
D <sup>a,b,c</sup>		41
E <sup>a,b,c</sup>		41
F <sup>a,b,c</sup>		33
G <sup>a,b,c</sup>		33
H <sup>a,b,c</sup>		28
J <sup>a,b,c</sup>		28
K <sup>a,c</sup>		19
M <sup>a,c</sup>		19
N <sup>a,c</sup>		22
P <sup>a,b,c</sup>		30

樓層	單位	分配予每個住宅物業的不分割份數的數目
第5座(5A)		
10樓至12樓、 15樓至23樓 及25樓	A <sup>a,b,c</sup>	48
	B <sup>a,b,c</sup>	41
	C <sup>a,b,c</sup>	71
	D <sup>a,b,c</sup>	41
	E <sup>a,b,c</sup>	41
	F <sup>a,b,c</sup>	33
	G <sup>a,b,c</sup>	33
	H <sup>a,b,c</sup>	28
	J <sup>a,b,c</sup>	28
	K <sup>a,c</sup>	19
	M <sup>a,c</sup>	19
	N <sup>a,c</sup>	22
P <sup>a,b,c</sup>	30	
26樓	A <sup>a,b,c,g</sup>	52
	B <sup>a,b,c,g</sup>	45
	C <sup>a,b,c,g</sup>	77
	D <sup>a,b,c,g</sup>	45
	E <sup>a,b,c,g</sup>	44
	F <sup>a,b,c,g</sup>	35
	G <sup>a,b,c,g</sup>	36
	H <sup>a,b,c,g</sup>	29
	J <sup>a,b,c,g</sup>	29
	K <sup>a,c,g</sup>	20
	M <sup>a,c,g</sup>	21
	N <sup>a,c,g</sup>	24
P <sup>a,b,c,g</sup>	32	

樓層	單位	分配予每個住宅物業的不分割份數的數目
第5座(5B)		
7樓	A <sup>a,b,c</sup>	29
	B <sup>a,b,c</sup>	29
	C <sup>a,c</sup>	22
	J <sup>e</sup>	19
	K <sup>e</sup>	18
	M <sup>a,b,c</sup>	30
	N <sup>e</sup>	26
8樓	A <sup>a,b,c</sup>	29
	B <sup>a,b,c</sup>	29
	C <sup>a,c</sup>	22
	J <sup>a,c</sup>	20
	K <sup>a,c</sup>	19
	M <sup>a,b,c</sup>	30
9樓	N <sup>a,b,c</sup>	29
	A <sup>a,b,c</sup>	29
	B <sup>a,b,c</sup>	29
	C <sup>a,c</sup>	21
	D <sup>e</sup>	19
	E <sup>e</sup>	19
	F <sup>a,b,c,e</sup>	32
	G <sup>e</sup>	29
	H <sup>e</sup>	18
	J <sup>a,c</sup>	19
	K <sup>a,c</sup>	19
	M <sup>a,b,c</sup>	30
N <sup>a,b,c</sup>	29	



樓層	單位	分配予每個住宅物業的不分割份數的數目
第5座(5B)		
10樓至12樓、 15樓至23樓 及25樓	A <sup>a,b,c</sup>	29
	B <sup>a,b,c</sup>	29
	C <sup>a,c</sup>	21
	D <sup>a,c</sup>	21
	E <sup>a,c</sup>	21
	F <sup>a,b,c</sup>	29
	G <sup>a,b,c</sup>	31
	H <sup>a,c</sup>	19
	J <sup>a,c</sup>	19
	K <sup>a,c</sup>	19
	M <sup>a,b,c</sup>	30
N <sup>a,b,c</sup>	29	

樓層	單位	分配予每個住宅物業的不分割份數的數目
第5座(5B)		
26樓	A <sup>a,b,c,g</sup>	31
	B <sup>a,b,c,g</sup>	32
	C <sup>a,c,g</sup>	22
	D <sup>a,c,g</sup>	22
	E <sup>a,c,g</sup>	22
	F <sup>a,b,c,g</sup>	31
	G <sup>a,b,c,g</sup>	33
	H <sup>a,c,g</sup>	21
	J <sup>a,c</sup>	19
	K <sup>a,c</sup>	19
	M <sup>a,b,c,g</sup>	31
N <sup>a,b,c,g</sup>	31	

註：

1. 所有座數不設4樓、13樓、14樓及24樓。
2. 不設第4座。
3. <sup>a</sup> 指連同露台的住宅單位。
4. <sup>b</sup> 指連同工作平台的住宅單位。
5. <sup>c</sup> 指連同空調機平台的住宅單位。
6. <sup>d</sup> 指連同空調機機房的住宅單位。
7. <sup>e</sup> 指連同平台的住宅單位。
8. <sup>f</sup> 指連同花園的住宅單位。
9. <sup>g</sup> 指連同天台的住宅單位。

**C. 有關期數的管理人的委任年期**

在不抵觸《建築物管理條例》(第344章)的情況下，管理公司(定義見公契)獲委任作為該地段及發展項目的管理人(定義見公契)，首屆任期由公契的日期起計兩(2)年，其後繼續任職直至根據公契的規定終止委任。

**D. 管理開支在期數中的住宅物業的擁有人之間分擔的基準**

1. 如果任何開支涉及或有利於該地段及發展項目(但並非僅涉及或僅有利於任何單位、住宅公用地方、停車場公用地方、住宅公用設施或停車場公用設施)、發展項目公用地方及/或發展項目公用設施，該等開支的全部金額須由發展項目的所有業主按其持有的管理份數(定義見公契)數目之比例進行分攤。
2. 如果任何開支僅涉及或僅有利於住宅單位(但並非僅涉及或僅有利於任何個別住宅單位)、住宅公用地方及/或住宅公用設施，該等開支的全部金額須由住宅單位的業主按其持有的管理份數數目之比例進行分攤。
3. 如果任何開支僅涉及或僅有利於停車位(但並非僅涉及或僅有利於任何個別停車位)、停車場公用地方及/或停車場公用設施，部份有關停車場公用地方及/或停車場公用設施的開支(相當於構成住宅公用地方一部分的訪客停車位(包括暢通易達停車位)的總樓面面積佔停車位及訪客停車位(包括暢通易達停車位)的總樓面面積之比例)須由住宅單位的業主按其持有的管理份數數目之比例承擔。
4. 如果任何開支僅涉及或僅有利於某個單位，該等開支的全部金額須由該單位業主承擔。

**E. 計算管理費按金的基準**

每個住宅單位須支付的管理費按金相當於該住宅單位三(3)個月的管理費。

**F. 擁有人在期數中保留作自用的範圍(如有的話)**

不適用。

This page left blank intentionally  
本頁故意留白

**1. The lot number of the land on which the Phase is situated**

Tuen Mun Town Lot No.518

**2. The term of years under the Government Lease**

50 years commencing from 11 February 2020

**3. The user restrictions applicable to that land**Special Condition No.(8) of the Land Grant

The lot or any part thereof or any building or part of any building erected or to be erected thereon shall not be used for any purpose other than for private residential purposes.

Special Condition No.(51) of the Land Grant

No grave or columbarium shall be erected or made on the lot, nor shall any human remains or animal remains whether in earthenware jars, cinerary urns or otherwise be interred therein or deposited thereon.

Special Condition No.(35) of the Land Grant

"No rock crushing plant shall be permitted on the lot without the prior written approval of the Director."

**4. General Condition No.7 of the Land Grant**

" (a) The Purchaser shall throughout the tenancy having built or rebuilt (which word refers to redevelopment as contemplated in sub-clause (b) of this General Condition) in accordance with these Conditions:

(i) maintain all buildings in accordance with the approved design and disposition and any approved building plans without variation or modification thereto; and

(ii) maintain all buildings erected or which may hereafter be erected in accordance with these Conditions or any subsequent contractual variation of them, in good and substantial repair and condition and in such repair and condition deliver up the same at the expiration or sooner determination of the tenancy.

(b) In the event of the demolition at any time during the tenancy of any building then standing on the lot or any part thereof, the Purchaser shall replace the same either by sound and substantial building or buildings of the same type and of no less gross floor area or by building or buildings of such type and value as shall be approved by the Director (i.e. Director of Lands). In the event of demolition as aforesaid, the Purchaser shall within one calendar month of such demolition apply to the Director for consent to carry out building works for the redevelopment of the lot and upon receiving such consent shall within three calendar months thereof commence the necessary redevelopment works and shall complete the same to the satisfaction of and within such time limit as is laid down by the Director."

**5. Special Condition No.(3) of the Land Grant**

" (a) The Purchaser shall:

(i) on or before the 31<sup>st</sup> day of March 2022 or such other date as may be approved by the Director, at the Purchaser's own expense, in such manner with such materials and to such standards, levels, alignment and design as the Director shall approve and in all respects to the satisfaction of the Director:

(I) lay and form that portion of future public road shown coloured green on the plan annexed hereto (hereinafter referred to as "the Green Areas"); and

(II) provide and construct within the Green Areas such bridges, tunnels, over-passes, under-passes, culverts, viaducts, flyovers, pavements, roads or such other structures as the Director in his sole discretion may require (hereinafter collectively referred to as "the Structures")

so that building, vehicular and pedestrian traffic may be carried on the Green Areas;

(ii) on or before the 31<sup>st</sup> day of March 2022 or such other date as may be approved by the Director, at the Purchaser's own expense and to the satisfaction of the Director, surface, kerb and channel the Green Areas and provide the same with such gullies, sewers, drains, fire hydrants with pipes connected to water mains, street lights, traffic signs, street furniture and road markings as the Director may require; and

(iii) maintain at the Purchaser's own expense the Green Areas together with the Structures and all structures, surfaces, gullies, sewers, drains, fire hydrants, services, street lights, traffic signs, street furniture, road markings and plant constructed, installed and provided thereon or therein to the satisfaction of the Director until such time as possession of the Green Areas has been delivered in accordance with Special Condition No.(4) hereof.

(b) In the event of the non-fulfilment of the Purchaser's obligations under sub-clause (a) of this Special Condition by the date specified therein or such other date as may be approved by the Director, the Government may carry out the necessary works at the cost of the Purchaser who shall pay to the Government on demand a sum equal to the cost thereof, such sum to be determined by the Director whose determination shall be final and binding upon the Purchaser.

(c) The Government shall have no responsibility or liability for any loss, damage, nuisance or disturbance whatsoever caused to or suffered by the Purchaser or any other person whether arising out of or incidental to the fulfilment of the Purchaser's obligations under sub-clause (a) of this Special Condition or the exercise of the rights by the Government under sub-clause (b) of this Special Condition or otherwise, and no claim whatsoever shall be made against the Government by the Purchaser in respect of any such loss, damage, nuisance or disturbance."

**6. Special Condition No.(4) of the Land Grant**

"The Purchaser shall at all reasonable times while he is in possession of the Green Areas allow free access over and along the Green Areas for all Government and public vehicular and pedestrian traffic and shall ensure that such access shall not be interfered with or obstructed by the carrying out of the works whether under Special Condition No.(3) hereof or otherwise."

**7. Special Condition No.(5) of the Land Grant**

"The Purchaser shall not without the prior written consent of the Director use the Green Areas for the purpose of storage or for the erection of any temporary structure or for any purposes other than the carrying out of the works specified in Special Condition No.(3) hereof."

**8. Special Condition No.(7) of the Land Grant**

"The Purchaser shall develop the lot by the erection thereon of a building or buildings complying in all respects with these Conditions and all Ordinances, bye-laws and regulations relating to building, sanitation and planning which are or may at any time be in force in Hong Kong, such building or buildings to be completed and made fit for occupation on or before the 31<sup>st</sup> day of March, 2026."

**9. Special Condition No.(10)(c) of the Land Grant**

"(i) The Purchaser shall at his own expense submit to the D of B (Director of Buildings) for his written approval a plan indicating such portion or portions of the lot or building or buildings erected or to be erected thereon at or within which greening (including but not limited to the provision of live plants with soil base) will be provided and maintained (hereinafter referred to as "the Greenery Area"), the layout and size of the Greenery Area and such other information (including but not limited to the location and particulars of the building works for the Greenery Area) as the D of B may require or specify at his sole discretion (which submission with plan is hereinafter referred to as "the Greenery Submission"). The decision of the D of B as to what constitutes the provision of greening under the Greenery Submission and which portion or portions of the lot or building or buildings constitute the Greenery Area shall be final and binding on the Purchaser. The aforesaid submission as approved by the D of B is hereinafter referred to as "the Approved Greenery Submission".

(ii) The Purchaser shall at his own expense implement and complete the building works for the Greenery Area in accordance with the Approved Greenery Submission and shall thereafter maintain the same in all respects to the satisfaction of the D of B. No amendment, variation, alteration, modification or substitution of the Approved Greenery Submission or the plan indicating the Greenery Area shall be made without the prior written approval of the D of B.

(iii) Except with the prior written approval of the D of B, the Greenery Area as shown in the Approved Greenery Submission shall be designated as and form part of the Common Areas referred to in Special Condition No.(21)(a)(v) hereof, and shall not be used for any purpose other than as the Greenery Area in accordance with the layout, size, location and particulars as set out in the Approved Greenery Submission."

**10. Special Condition No.(13) of the Land Grant**

"(a) The Purchaser may erect, construct and provide within the lot such recreational facilities and facilities ancillary thereto (hereinafter referred to as "the Facilities") as may be approved in writing by the Director. The type, size, design, height and disposition of the Facilities shall also be subject to the prior written approval of the Director.

(c) In the event that any part of the Facilities is exempted from the gross floor area calculation pursuant to sub-clause (b) of this Special Condition (hereinafter referred to as "the Exempted Facilities"):

(i) the Exempted Facilities shall be designated as and form part of the Common Areas referred to in Special Condition No.(21)(a)(v) hereof;

(ii) the Purchaser shall at his own expense maintain the Exempted Facilities in good and substantial repair and condition and shall operate the Exempted Facilities to the satisfaction of the Director; and

(iii) the Exempted Facilities shall only be used by the residents of the residential block or blocks erected or to be erected on the lot and their bona fide visitors and by no other person or persons."

**11. Special Condition No.(14) of the Land Grant**

"No tree growing on the lot or adjacent thereto shall be removed or interfered with without the prior written consent of the Director who may, in granting consent, impose such conditions as to transplanting, compensatory landscaping or replanting as he may deem appropriate."

**12. Special Condition No.(15) of the Land Grant**

"The Purchaser shall at his own expense landscape the lot in accordance with the approved landscape plan in all respects to the satisfaction of the Director, and no amendment, variation, alteration, modification or substitution of the approved landscape plan shall be made without the prior written consent of the Director."

**13. Special Condition No.(24) of the Land Grant**

"(a) (i) Spaces shall be provided within the lot to the satisfaction of the Director for the parking of motor vehicles licensed under the Road Traffic Ordinance, any regulations made thereunder and any amending legislation, and belonging to the residents of the building or buildings erected or to be erected on the lot and their bona fide guests, visitors or invitees (hereinafter referred to as "the Residential Parking Spaces") at a rate to be calculated by reference to the respective type(s) and size(s) of the residential units or houses erected or to be erected on the Lot as set out in Special Condition No.(24)(a)(i) of the Land Grant.

- (iii) Additional spaces for the parking of motor vehicles licensed under the Road Traffic Ordinance, any regulations made thereunder and any amending legislation, and belonging to the bona fide guests, visitors or invitees of the residents of the building or buildings erected or to be erected on the lot shall be provided within the lot to the satisfaction of the Director, at the rates prescribed under Special Condition No.(24)(a)(iii) of the Land Grant or at such other rates as may be approved by the Director, subject to a minimum of 2 such spaces being provided within the lot.
  - (iv) The spaces provided under sub-clauses (a)(i) and (a)(iii) of this Special Condition (as may be respectively varied under Special Condition No.(27) hereof) shall not be used for any purpose other than those respectively stipulated therein and in particular the said spaces shall not be used for the storage, display or exhibiting of motor vehicles for sale or otherwise or for the provision of car cleaning and beauty services.
- (b) (i) Out of the spaces provided under sub-clauses (a)(i)(I) and (a)(iii) of this Special Condition (as may be respectively varied under Special Condition No.(27) hereof), the Purchaser shall reserve and designate such number of spaces for the parking of motor vehicles by disabled persons as defined in the Road Traffic Ordinance, any regulations made thereunder and any amending legislation (which spaces to be so reserved and designated are hereinafter referred to as “the Parking Spaces for Disabled Persons”) as the Building Authority may require and approve provided that a minimum of one space shall be so reserved and designated out of the spaces provided under sub-clause (a)(iii) of this Special Condition (as may be varied under Special Condition No.(27) hereof) and that the Purchaser shall not reserve or designate all of the spaces provided under sub-clause (a)(iii) of this Special Condition (as may be varied under Special Condition No.(27) hereof) to become the Parking Spaces for Disabled Persons.
- (ii) The Parking Spaces for Disabled Persons shall not be used for any purpose other than for the parking of motor vehicles by disabled persons as defined in the Road Traffic Ordinance, any regulations made thereunder and any amending legislation, and belonging to the residents of the building or buildings erected or to be erected on the lot and their bona fide guests, visitors or invitees and in particular the said spaces shall not be used for the storage, display or exhibiting of motor vehicles for sale or otherwise or for the provision of car cleaning and beauty services.
- (c) (i) Spaces shall be provided within the lot to the satisfaction of the Director for the parking of motor cycles licensed under the Road Traffic Ordinance, any regulations made thereunder and any amending legislation, and belonging to the residents of the building or buildings erected or to be erected on the lot and their bona fide guests, visitors or invitees (hereinafter referred to as “the Motor Cycle Parking Spaces”) at the rates prescribed under Special Condition No.(24)(c) (i) of the Land Grant or at such other rates as may be approved by the Director.
- (ii) The Motor Cycle Parking Spaces (as may be varied under Special Condition No.(27) hereof) shall not be used for any purpose other than for the purpose set out in sub-clause (c)(i) of this Special Condition and in particular the said spaces shall not be used for the storage, display or exhibiting of motor vehicles for sale or otherwise or for the provision of car cleaning and beauty services.”

#### 14. Special Condition No.(25) of the Land Grant

- “(a) Spaces shall be provided within the lot to the satisfaction of the Director for the loading and unloading of goods vehicles at the rate prescribed under Special Condition No.(25)(a) of the Land Grant or at such other rates as may be approved by the Director, subject to a minimum of one loading and unloading space for each block of residential units erected or to be erected on the lot, such loading and unloading space to be located adjacent to or within each block of residential units.
- (b) Such spaces shall not be used for any purpose other than for the loading and unloading of goods vehicles in connection with the building or buildings erected or to be erected on the lot.”

#### 15. Special Condition No.(26) of the Land Grant

“Spaces shall be provided within the lot to the satisfaction of the Director for the parking of bicycles belonging to the residents of the building or buildings erected or to be erected on the lot and their bona fide guests, visitors or invitees at the rate prescribed under Special Condition No.(26) of the Land Grant or at such other rates as may be approved by the Director. The spaces to be provided under this Special Condition shall not be used for any purpose other than for the parking of bicycles belonging to the residents of the building or buildings erected or to be erected on the lot and their bona fide guests, visitors or invitees.”

#### 16. Special Condition No.(29) of the Land Grant

- “(a) Notwithstanding that these Conditions shall have been observed and complied with to the satisfaction of the Director, the Residential Parking Spaces and the Motor Cycle Parking Spaces shall not be:
- (i) assigned except:
    - (I) together with undivided shares in the lot giving the right of exclusive use and possession of a residential unit or units in the building or buildings erected or to be erected on the lot; or
    - (II) a person who is already the owner of undivided shares in the lot with the right of exclusive use and possession of a residential unit or units in the building or buildings erected or to be erected on the lot; or
  - (ii) underlet except to residents of the residential units in the building or buildings erected or to be erected on the lot.

Provided that in any event not more than three in number of the total of the Residential Parking Spaces and the Motor Cycle Parking Spaces shall be assigned to the owner or underlet to the resident of any one residential unit in the building or buildings erected or to be erected on the lot.”

#### 17. Special Condition No.(30) of the Land Grant

“The spaces provided within the lot in accordance with Special Conditions No.(24)(a)(iii) hereof (as may be varied under Special Condition No.(27) hereof) and Special Conditions Nos.(25)(a) and (26) hereof shall be designated as and form part of the Common Areas.”

**18. Special Condition No.(31) of the Land Grant**

“The parking, loading and unloading spaces indicated on the car park layout plan approved by and deposited with the Director shall not be used for any purpose other than for the purposes set out respectively in Special Conditions Nos.(24), (25) and (26) hereof. The Purchaser shall maintain the parking, loading and unloading spaces and other areas, including but not restricted to the lifts, landings and manoeuvring and circulation areas, in accordance with the said approved plan and shall not alter the layout except with the prior written consent of the Director. Except for the parking spaces indicated on the said approved plan, no part of the lot or any building or structure thereon shall be used for parking purposes.”

**19. Special Condition No.(33) of the Land Grant**

“The Purchaser shall not cut away, remove or set back any Government land adjacent to or adjoining the lot or carry out any building-up, filling-in or any slope treatment works of any kind whatsoever on any Government land except as provided in Special Condition No.(37) hereof or with the prior written consent of the Director who may, at his sole discretion, give his consent subject to such terms and conditions as he sees fit, including the grant of additional Government land as an extension to the lot at such premium as he may determine.”

**20. Special Condition No.(34) of the Land Grant**

- “(a) Where there is or has been any cutting away, removal or setting back of any land, or any building-up or filling-in or any slope treatment works of any kind whatsoever, whether with or without the prior written consent of the Director, either within the lot or on any Government land, which is or was done for the purpose of or in connection with the formation, levelling or development of the lot or any part thereof or any other works required to be done by the Purchaser under these Conditions, or for any other purpose, the Purchaser shall at his own expense carry out and construct such slope treatment works, retaining walls or other support, protection, drainage or ancillary or other works as shall or may then or at any time thereafter be necessary to protect and support such land within the lot and also any adjacent or adjoining Government or leased land and to obviate and prevent any falling away, landslip or subsidence occurring thereafter. The Purchaser shall at all times during the term hereby agreed to be granted maintain at his own expense the said land, slope treatment works, retaining walls or other support, protection, drainage or ancillary or other works in good and substantial repair and condition to the satisfaction of the Director.
- (c) In the event that as a result of or arising out of any formation, levelling, development or other works done by the Purchaser or owing to any other reason, any falling away, landslip or subsidence occurs at any time, whether in or from any land, within the lot or from any adjacent or adjoining Government or leased land, the Purchaser shall at his own expense reinstate and make good the same to the satisfaction of the Director and shall indemnify and keep indemnified the Government from and against all liabilities, claims, losses, damages, expenses, charges, costs, demands, actions and proceedings whatsoever and howsoever arising whether directly or indirectly out of or in connection with such falling away, landslip or subsidence.

- (d) In addition to any other rights or remedies herein provided for breach of any of these Conditions, the Director shall be entitled by notice in writing to call upon the Purchaser to carry out, construct and maintain the said land, slope treatment works, retaining walls, or other support, protection, and drainage or ancillary or other works or to reinstate and make good any falling away, landslip or subsidence, and if the Purchaser shall neglect or fail to comply with the notice to the satisfaction of the Director within the period specified therein, the Director may forthwith execute and carry out any necessary works and the Purchaser shall on demand repay to the Government the cost thereof, together with any administrative or professional fees and charges.”

**21. Special Condition No.(36) of the Land Grant**

“Where prestressed ground anchors have been installed, upon development or redevelopment of the lot or any part thereof, the Purchaser shall at his own expense carry out regular maintenance and regular monitoring of the prestressed ground anchors throughout their service life to the satisfaction of the Director and shall supply to the Director such reports and information on all such monitoring works as the Director may from time to time in his absolute discretion require. If the Purchaser shall neglect or fail to carry out the required monitoring works, the Director may forthwith execute and carry out the monitoring works and the Purchaser shall on demand repay to the Government the cost thereof.”

**22. Special Condition No.(37) of the Land Grant**

- “(a) The Purchaser hereby acknowledges and accepts that the lot may be affected by landslide and boulder fall hazards arising from areas within the lot and the areas outside the lot shown edged by pecked green lines for identification purpose on the plan annexed hereto (hereinafter referred to as “the Edged Pecked Green Areas”) due to the nature of the natural terrain.
- (c) The Purchaser shall on or before the 31<sup>st</sup> day of March, 2026 or such other date as may be approved by the Director, at the Purchaser’s own expense carry out and complete in all respects to the satisfaction of the Director such mitigation and stabilisation works and associated works, including works for the Maintenance Access, within the lot (hereinafter collectively referred to as “the Inside Works”) and on the Edged Pecked Green Areas or any other Government land (hereinafter collectively referred to as “the Outside Works”) in accordance with the Approved Mitigation Proposal (as defined under Special Condition No.(37)(b)(ii) of the Land Grant) as the Director in his absolute discretion shall approve or require. No part of the lot, building or buildings and structure or structures erected or to be erected on the lot which may be affected by landslide and boulder fall hazards as identified in the Investigation (as defined under Special Condition No.(37)(b)(i) of the Land Grant) shall be occupied by any residents or occupiers and their bona fide guests, visitors or invitees before completion of the Inside Works and the Outside Works.
- (f) (i) The Purchaser shall at all times during the term hereby agreed to be granted, maintain at his own expense the Inside Works and the Outside Works in good and substantial repair and condition in all respects to the satisfaction of the Director to ensure that the Inside Works and the Outside Works shall continue to perform their designed functions. The maintenance works shall include but not be limited to clearance of landslide debris or boulders fallen onto the Inside Works or the Outside Works or onto the areas of the lot or the Government land shown on the Natural Terrain Hazard Mitigation and Stabilisation Works Plan (as defined under Special Condition No.(37)(e) of the Land Grant).

(ii) In addition to any rights or remedies the Government may have against the Purchaser for breach of the Purchaser's obligations to maintain the Inside Works and the Outside Works as herein provided, the Director shall be entitled by notice in writing to call upon the Purchaser to carry out such maintenance works to the Inside Works and the Outside Works within such period as the Director shall in his absolute discretion deem fit. If the Purchaser shall neglect or fail to comply with such notice in all respects to the satisfaction of the Director within the period specified therein, the Director may forthwith execute and carry out the required maintenance works and the Purchaser shall on demand repay the Government the cost thereof, together with such supervisory and overhead charges as may be fixed by the Director or by his duly authorized officers whose determination shall be final and binding on the Purchaser.

(h) In the event that as a result of or arising out of carrying out the Investigation or carrying out, inspecting, checking, supervising and maintaining the Inside Works or the Outside Works, any damage is done to the Edged Pecked Green Areas or any other Government land, the Purchaser shall make good such damage at his own expense within such time limit as shall be determined by the Director at his absolute discretion and in all respects to the satisfaction of the Director. In the event of the non-fulfilment of the Purchaser's obligations under this sub-clause (h) within the time limit as aforesaid, the Director may forthwith execute and carry out the required works and the Purchaser shall on demand repay the Government the cost thereof, together with such supervisory and overhead charges as may be fixed by the Director or by his duly authorized officers whose determination shall be final and binding on the Purchaser."

### 23. Special Condition No.(39) of the Land Grant

"Subject to Special Condition No.(40) hereof, the Purchaser shall take or cause to be taken all proper and adequate care, skill and precautions at all times, and particularly when carrying out construction, maintenance, renewal or repair work (hereinafter referred to as "the Works"), to avoid causing any damage, disturbance or obstruction to any Government or other existing drain, waterway or watercourse, water main, road, footpath, street furniture, sewer, nullah, pipe, cable, wire, utility service or any other works or installations being or running upon, over, under or adjacent to the lot, the Green Areas, the Edged Pecked Green Areas or any part of any of them (hereinafter collectively referred to as "the Services"). The Purchaser shall prior to carrying out any of the Works make or cause to be made such proper search and enquiry as may be necessary to ascertain the present position and levels of the Services, and shall submit his proposals for dealing with any of the Services which may be affected by the Works in writing to the Director for his approval in all respects, and shall not carry out any work whatsoever until the Director shall have given his written approval to the Works and to such aforesaid proposals. The Purchaser shall comply with and at his own expense meet any requirements which may be imposed by the Director in respect of the Services in granting the aforesaid approval, including the cost of any necessary diversion, relaying or reinstatement. The Purchaser shall at his own expense and in all respects repair, make good and reinstate to the satisfaction of the Director any damage, disturbance or obstruction caused to the lot, the Green Areas, the Edged Pecked Green Areas or any part of any of them or any of the Services in any manner arising out of the Works (except for nullah, sewer, storm-water drain or water main, the making good of which shall be carried out by the Director, unless the Director elects otherwise, and the Purchaser shall pay to the Government on demand the cost of such works). If the Purchaser fails to carry out any such necessary diversion, relaying, repairing, making good and reinstatement of the lot, the Green Areas, the Edged Pecked Green Areas or any part of any of them or of any of the Services to the satisfaction of the Director, the Director may carry out any such diversion, relaying, repairing, making good or reinstatement as he considers necessary and the Purchaser shall pay to the Government on demand the cost of such works."

### 24. Special Condition No.(40) of the Land Grant

- "(a) The Purchaser hereby acknowledges that as at the date of this Agreement, there are some existing utility installations belonging to the CLP Power Hong Kong Limited (hereinafter referred to as "the CLP") for supplying utility services to the facilities of the Highways Department and the Transport Department including but not limited to low voltage electricity cables, wood poles and overhead lines within the lot at the approximate location and along the alignment as shown for identification purpose only by red lines on the plan annexed hereto (which said utility installations are hereinafter collectively referred to as "the Existing CLP Installations").
- (d) The Purchaser shall on or before the 31<sup>st</sup> day of March, 2026 or such other date as may be approved by the Director, at the Purchaser's own expense and in all respects to the satisfaction of the Director and the CLP divert the Existing CLP Installations to such part or parts of the lot as may be approved or required by the Director (hereinafter referred to as "the Diversion Works for the Existing CLP Installations") in accordance with the proposal as approved under sub-clause (e) of this Special Condition and in compliance with all requirements which may be imposed by the Director in granting the aforesaid approval."

### 25. Special Condition No.(41) of the Land Grant

- "(a) The Purchaser hereby acknowledges that as at the date of this Agreement, there are two graves near the lot, which are for identification purpose only shown and marked "Grave 1" and "Grave 2" respectively on the plan annexed hereto (hereinafter collectively referred to as "the Existing Graves"). Before the Pedestrian Walkway (as defined in sub-clause (b) of this Special Condition) has been completed in all respects to the satisfaction of the Director, the Purchaser shall at all reasonable times permit the Government and all members of the public to have free and uninterrupted access and without payment of any nature whatsoever to pass and repass on foot on, along or through such route within the lot to and from the Existing Graves in all respects to the satisfaction of the Director.
- (b) (i) The Purchaser shall on or before the 31<sup>st</sup> day of March, 2026 or such other date as may be approved by the Director at his own expense and in all respects to the satisfaction of the Director lay, form, provide, construct and surface a pedestrian walkway or walkways, or a footpath or footpaths (together with such stairs, ramps and lightings as the Director at his absolute discretion may require) within the lot (hereinafter referred to as "the Pedestrian Walkway") to and from the Existing Graves at such position, in such manner, with such materials and to such standards, levels, alignment and designs as the Director shall approve.
- (ii) Upon completion of the Pedestrian Walkway, the Purchaser shall at all reasonable times throughout the term hereby agreed to be granted permit all members of the public to have free and uninterrupted access and without payment of any nature whatsoever to pass and repass on foot on, along or through the Pedestrian Walkway to and from the Existing Graves.
- (c) The Purchaser shall throughout the term hereby agreed to be granted at his own expense keep and maintain the Pedestrian Walkway in good and substantial repair and condition in all respects to the satisfaction of the Director.
- (e) The Pedestrian Walkway shall be designated as and form part of the Common Areas."



**26. Special Condition No.(42) of the Land Grant**

- “(a) The Purchaser shall construct and maintain at his own expense and to the satisfaction of the Director such drains and channels, whether within the boundaries of the lot or on Government land, as the Director may consider necessary to intercept and convey into the nearest stream-course, catchpit, channel or Government storm-water drain all storm-water or rainwater falling or flowing on to the lot, and the Purchaser shall be solely liable for and shall indemnify the Government and its officers from and against all liabilities, claims, losses, damages, expenses, charges, costs, demands, actions and proceedings whatsoever and howsoever arising whether directly or indirectly out of or in connection with any damage or nuisance caused by such storm-water or rain-water.
- (b) The works of connecting any drains and sewers from the lot to the Government storm-water drains and sewers, when laid and commissioned, may be carried out by the Director who shall not be liable to the Purchaser for any loss or damage thereby occasioned and the Purchaser shall pay to the Government on demand the cost of such connection works. Alternatively, the said connection works may be carried out by the Purchaser at his own expense to the satisfaction of the Director and in such case any section of the said connection works which is constructed within Government land shall be maintained by the Purchaser at his own cost and upon demand be handed over by the Purchaser to the Government for future maintenance thereof at the expense of the Government and the Purchaser shall pay to the Government on demand the cost of the technical audit in respect of the said connection works. The Director may, upon failure of the Purchaser to maintain any section of the said connection works which is constructed within Government land, carry out such maintenance works as he considers necessary and the Purchaser shall pay to the Government on demand the cost of such works.”

**27. Special Condition No.(43) of the Land Grant**

- “(b) The Purchaser shall at his own expense and within such time limit as may be stipulated by the Director of Environmental Protection carry out and implement the recommendations in the SIA (as defined under Special Condition No.(43)(a) of the Land Grant) as approved by the Director of Environmental Protection in all respects to the satisfaction of the Director of Environmental Protection.
- (e) For the avoidance of doubt and without prejudice to the generality of the provisions of General Condition No.5 hereof, the Purchaser hereby expressly acknowledges and agrees that he shall have the sole responsibility at his own expense to carry out and implement the recommendations in the SIA as approved by the Director of Environmental Protection in all respects to the satisfaction of the Director of Environmental Protection.”

**28. Special Condition No.(44) of the Land Grant**

- “(b) The Purchaser shall at his own expense and within such time limit as may be stipulated by the Director of Drainage Services carry out and implement the recommendations in the DIA (as defined under Special Condition No.(44)(a) of the Land Grant) as approved by the Director of Drainage Services in all respects to the satisfaction of the Director of Drainage Services.

- (e) For the avoidance of doubt and without prejudice to the generality of the provisions of General Condition No.5 hereof, the Purchaser hereby expressly acknowledges and agrees that he shall have the sole responsibility at his own expense to carry out and implement the recommendations in the DIA as approved by the Director of Drainage Services in all respects to the satisfaction of the Director of Drainage Services.”

**29. Special Condition No.(45) of the Land Grant**

- “(b) The Purchaser shall at his own expense and within such time limit as may be stipulated by the Director carry out and implement the Noise Mitigation Measures (as defined under Special Condition No.(45)(a) of the Land Grant) contained in the NIA (as defined under Special Condition No.(45)(a) of the Land Grant) and approved by the Director (hereinafter referred to as “the Approved Noise Mitigation Measures”) in all respects to the satisfaction of the Director.
- (d) For the avoidance of doubt and without prejudice to the generality of the provisions of General Condition No.5 hereof, the Purchaser hereby expressly acknowledges and agrees that the Purchaser shall have the sole responsibility to carry out and implement at his own expense the Approved Noise Mitigation Measures in all respects to the satisfaction of the Director.”

**30. Special Condition No.(46) of the Land Grant**

“In the event that the Approved Noise Mitigation Measures comprise the erection or construction of a noise barrier or noise barriers on the lot with projection extending beyond the boundary of the lot and over and above any adjoining Government land (hereinafter referred to as “the Noise Barrier”), the following conditions shall apply:

- (a) the Purchaser shall at his own expense design, erect and construct the Noise Barrier in accordance with the plans approved by the Building Authority and in all respects in compliance with the Buildings Ordinance, any regulations made thereunder and any amending legislation;
- (c) no alteration, addition, replacement or attachment whatsoever shall be made or affixed to or upon the Noise Barrier or any part or parts thereof except with the prior written approval of the Director;
- (d) the Purchaser shall at all times and at his own expense uphold, maintain and repair the Noise Barrier or (where approved by the Director) any replacement thereof in good and substantial repair and condition in all respects to the satisfaction of the Director;
- (e) the Noise Barrier shall not be used for any purpose other than for noise barrier, and except with the prior written consent of the Director, the Purchaser shall not use or suffer or allow to be used the Noise Barrier or any part or parts thereof for advertising or for the display of any signs, notices or posters whatsoever;
- (g) the Purchaser shall at all times take such precautions as may be necessary to prevent any damage or injury being caused to any Government land adjoining the lot and the Noise Barrier or to any persons or vehicles entering or using any Government land adjoining the lot and the Noise Barrier as a result of the erection, construction, presence, inspection, repair, maintenance, cleaning, renewal, alteration, replacement, use, demolition or removal of the Noise Barrier or any part or parts thereof or the addition or attachment to the Noise Barrier or any part or parts thereof;

- (h) the Director shall, at any time and at his absolute discretion, have the right to serve upon the Purchaser a written notice requiring the Purchaser to demolish and remove the part or parts of the Noise Barrier that project over the Government land without any replacement within six calendar months from the date of the written notice and upon receipt of such written notice, the Purchaser shall at his own expense demolish and remove the aforesaid part or parts of the Noise Barrier within such period as stipulated in such written notice and in all respects to the satisfaction of the Director;
- (i) in the event of the non-fulfilment of the Purchaser's obligations under this Special Condition, the Director may carry out the necessary works and the Purchaser shall pay to the Director on demand the cost of such works, such sum to be determined by the Director whose determination shall be final and binding on the Purchaser;"

### 31. Special Condition No.(47) of the Land Grant

- "(b) The Purchaser shall at his own expense and within such time limit as may be stipulated by the Director of Planning carry out and implement the recommendations contained in the AVA (as defined under Special Condition No.(47)(a) of the Land Grant) as approved by the Director of Planning in all respects to the satisfaction of the Director of Planning.
- (d) For the avoidance of doubt and without prejudice to the generality of the provisions of General Condition No.5 hereof, the Purchaser hereby expressly acknowledges and agrees that the Purchaser shall have the sole responsibility to carry out and implement at his own expense the recommendations contained in the AV A as approved by the Director of Planning in all respects to the satisfaction of the Director of Planning."

#### Remarks :-

1. The reference to the "Purchaser" in the Land Grant means the Purchaser under the Land Grant and includes, where the context so admits or requires, his executors, administrators and assigns and in the case of a corporation its successors and assigns.
2. The reference to the "Director" in the Land Grant means the Director of Lands.
3. The capitalized terms used in this Summary of Land Grant shall have the same meaning as defined in the Land Grant.

**1. 期數所位於的土地的地段編號**

屯門市地段第518號

**2. 有關租契規定的年期**

由2020年2月11日起計50年

**3. 適用於該土地的用途限制**

特別條款第(8)條

該地段或其任何部份或在其上已建或擬建的任何建築物或任何建築物部份不得用作私人住宅以外的任何用途。

特別條款第(51)條

不得在該地段興建或製作墳墓或骨灰龕，亦不得在其內或其上用泥壇、骨灰盒或其他形式埋葬或存放人類遺骸或動物遺骸。

特別條款第(35)條

「未得署長事先書面批准，不得在該地段使用碎石機。」

**4. 批地文件一般條款第7條**

「(a) 購買人須在整個租期期間按此等條款對已建或重建(該詞指本一般條款第(b)分條預期的重新發展)：

- (i) 按核准的設計、布局及任何核准建築圖則保養一切建築物，不得對其作出修訂或更改；及
- (ii) 保養已建或今後按此等條款或任何其後合同修訂興建的一切建築物，使其處於修葺良好堅固的狀態，並於租期結束或提前終止時以同等狀態交還此等建築物。

- (b) 倘若在租期的任何時候清拆當時在該地段或其中任何部份上面的任何建築物，購買人須以相同類型和不少於其總樓面面積的品質良好及堅固的建築物或署長(即：地政總署署長)批准的類型及價值的建築物作為代替。如果進行上述清拆，購買人須在上述清拆的一個曆月內向署長申請其同意進行重新發展該地段的建築工程，並在收到上述同意後必須在三個曆月內開展重新發展的必要工程及在署長規定的期限內以署長滿意的方式完成該等工程。」

**5. 批地文件特別條款第(3)條**

「(a) 購買人須：

- (i) 於2022年3月31日或署長批准的其他日期之前按署長批准的方式、材料、標準、水平、定線及設計自費並在一切方面使署長滿意：

- (I) 鋪設及構建於附錄的圖則上用綠色顯示的未來公共道路之部份(以下簡稱「綠色範圍」)；及
- (II) 提供及建造按署長可全權酌情決定要求之橋樑、隧道、立交橋、地下通道、暗渠、高架橋、天橋、行人路、道路或其他構築物(以下統稱「該等構築物」)

使建築物、車輛及行人往來可於綠色範圍進行；

- (ii) 於2022年3月31日或署長可批准的其他日期之前，自費在綠色範圍鋪設路面、路緣及渠道，並為其提供署長可能要求的明渠、污水渠、排水渠、消防龍頭連同接駁至總喉的喉管、街燈、交通標誌、街道設施及道路標記，使署長滿意；及

- (iii) 自費保養綠色範圍連同該等構築物以及在其之上或之內興建、設置及提供的所有構築物、路面、明渠、污水渠、排水渠、消防龍頭、服務、街燈、交通標誌、街道設施、道路標記及植物，使署長滿意，直至按特別條款第(4)條交還綠色範圍的管有權給政府。

- (b) 倘若購買人未能在本特別條款第(a)分條指定的日期或署長可批准的其他日期之前履行本特別條款第(a)分條下的責任，政府可進行必要的工程，費用由購買人承擔。購買人須在接獲要求時向政府支付相等於該工程費用的金額，該金額由署長決定，其決定為最終決定並對購買人有約束力。

- (c) 政府對購買人履行其在本特別條款第(a)分條的責任或政府行使本特別條款第(b)分條或其他情況賦予的權利所產生或附帶造成購買人或任何其他人士蒙受的任何損失、損害、滋擾或干擾毋須承擔任何責任。購買人不得就上述任何損失、損害、滋擾或干擾向政府索償。」

**6. 批地文件特別條款第(4)條**

「購買人須於所有合理時間在其管有綠色範圍或任何部份期間，准許所有政府及公共車輛及行人交通自由進入、通過及經過綠色範圍，並確保該項進入的權利不受進行的工程干擾或阻礙，不論是按照批地文件的特別條款第(3)條或其他規定進行的工程。」

**7. 批地文件特別條款第(5)條**

「未經署長的預先書面同意，購買人不得使用綠色範圍作儲物用途、或搭建任何臨時構築物，或除進行特別條款第(3)條指定的工程外的任何用途。」

**8. 批地文件特別條款第(7)條**

「買方須在該地段上興建一項或多項建築物以發展該地段，並須在所有方面符合批地文件的條款和香港不時有效及有關建築、衛生及規劃的一切條例、附例及規例，該建築物或該等建築物須於2026年3月31日或之前完成和可供佔用。」

**9. 批地文件特別條款第(10)(c)條**

- 「(i) 購買人應自費將一圖則提交屋宇署署長(以下簡稱「屋宇署署長」)以獲得其書面批准,該圖則顯示將於其中或其內提供和保養綠化(包括但不限於提供帶土基的活體植物)(以下簡稱「綠化範圍」),綠化範圍的佈局和大小以及屋宇署署長可全權酌情要求或指定的其他資訊(包括但不限於綠化範圍建築工程的位置和詳情(該項連圖則之提交以下簡稱「該項綠化提交」)。屋宇署署長關於何者構成該項綠化提交下之綠化提供及該地段或該地段之已或將建立的建築物之何一部份或何等部份構成綠化範圍的決定是最終決定,對購買人具有約束力。上述獲屋宇署署長批准的提交以下簡稱「核准綠化提交」。
- (ii) 購買人應根據核准綠化提交自費進行並完成綠化範圍的建築工程及於之後以屋宇署署長全面滿意的方式保養綠化範圍。未經屋宇署署長的事先書面批准,不得對核准綠化提交或顯示綠化範圍的圖則進行任何修改、變更、更改、改動或替代;及
- (iii) 除得到屋宇署署長的事先書面批准外,該項綠化提交中所示的綠化範圍應指定為並構成特別條款第(21)(a)(v)條所述的公用地方的一部份,且除用作按核准綠化提交所列佈局、大小、位置和詳情之綠化範圍外,不得就任何目的使用。」

**10. 批地文件特別條款第(13)條**

- 「(a) 經署長書面批准,購買人可在該地段內搭建、建築及提供康樂設施及其輔助設施(以下簡稱「該等設施」),該等設施的類型、大小、設計、高度及布局亦須經署長的預先書面批准。
- (c) 倘若該等設施任何部份被豁免列入計算本特別條款第(b)分條的總樓面面積(以下簡稱「該等獲豁免設施」):
- (i) 該等獲豁免設施須指定為並構成特別條款第(21)(a)(v)條提及的該等公用地方一部份;
- (ii) 購買人須自費保養該等獲豁免設施,使其處於修葺良好堅固的狀態並操作該等獲豁免設施,使署長滿意;及
- (iii) 該等獲豁免設施僅可供該地段上已建或擬建的住宅大廈的住戶和他們的真正訪客使用,而非其他人士使用。」

**11. 批地文件特別條款第(14)條**

「未經署長事先書面同意,不得移除或干擾該地段或毗連範圍內生長的樹木。署長在發出同意時,可就樹木移植、補償性景觀美化或再植施加他認為合適的條件。」

**12. 批地文件特別條款第(15)條**

「購買人須自費按核准的園景設計圖在該地段提供園景,在一切方面使署長滿意。未經署長預先書面同意,不得修訂、更改、改變、變更或替代核准的園景設計圖。」

**13. 批地文件特別條款第(24)條**

- 「(a) (i) 必須在該地段內按批地文件特別條款第(24)(a)(i)條所列根據已建或擬建之住宅單位或房屋的分別類型和大小而計算得出的比率提供車位,供停泊根據《道路交通條例》、其下的任何規例及任何修訂法例獲發牌並屬於該地段上已建或擬建的建築物之住戶和他們的真正來賓、訪客或被邀請者的車輛(以下簡稱「住宅停車位」),使署長滿意。

- (iii) 必須在該地段內按批地文件特別條款第(24)(a)(iii)條所列的比率或署長批准的其他比率提供額外的車位以供停泊根據《道路交通條例》、其下的任何規例及任何修訂法例獲發牌並屬於該地段上已建或擬建的建築物之住戶的真正來賓、訪客或被邀請者的車輛,使署長滿意,惟在該地段內至少須提供兩個該等車位。

- (iv) 按本特別條款第(a)(i)分條及第(a)(iii)分條(可按特別條款第(27)條分別更改)提供的車位不得用作該等分條分別訂定以外的任何用途,尤其是上述車位不得用作車輛存放、陳列或展示以作出售或其他用途或提供汽車清潔及美容服務。

- (b) (i) 按本特別條款第(a)(i)(I)分條及第(a)(iii)分條(可按特別條款第(27)條分別更改)提供的車位中,購買人須按建築事務監督要求及批准保留與指定車位數目,供《道路交通條例》、其下的任何規例及任何修訂法例界定的傷殘人士停泊車輛(該等如此保留及指定的車位下文稱為「傷殘人士停車位」),惟必須在按本特別條款第(a)(iii)分條(可按特別條款第(27)條更改)提供的車位中如此保留與指定至少一個車位,且購買人不得保留或指定按本特別條款第(a)(iii)分條(可按特別條款第(27)條更改)提供的全部車位作為傷殘人士停車位。

- (ii) 傷殘人士停車位不得用作《道路交通條例》、其下的任何規例及任何修訂法例界定的傷殘人士停泊屬於該地段上已建或擬建的建築物之住戶和他們的真正來賓、訪客或被邀請者的車輛以外的任何用途,尤其是上述車位不得用作車輛存放、陳列或展示以作出售或其他用途或提供汽車清潔及美容服務。

- (c) (i) 必須在該地段內按批地文件特別條款第(24)(c)(i)條所列的比率或署長批准的其他比率提供車位,供停泊根據《道路交通條例》、其下的任何規例及任何修訂法例獲發牌並屬於該地段上已建或擬建的建築物之住戶和他們的真正來賓、訪客或被邀請者的電單車(以下簡稱「電單車停車位」),以使署長滿意。

- (ii) 電單車停車位(可按特別條款第(27)條更改)不得用作按本特別條款第(c)(i)分條所列明以外的任何用途,尤其是上述車位不得用作車輛存放、陳列或展示以作出售或其他用途或提供汽車清潔及美容服務。」

**14. 批地文件特別條款第(25)條**

- 「(a) 必須該地段內按批地文件特別條款第(25)(a)條所列的比率或署長批准的其他比率提供車位,供貨車裝卸,以使署長滿意,惟在該地段上已建或擬建的每座住宅單位大廈須至少有一個上落貨車位,該上落貨車位須設在每座住宅單位大廈旁邊或之內。

- (b) 按本特別條款第(a)分條提供的每個車位不得用作與該地段上已建或擬建的一座或多座建築物有關的貨車裝卸以外的任何用途。」

**15. 批地文件特別條款第(26)條**

「必須該地段內按批地文件特別條款第(26)條所列的比率或署長批准的其他比率提供車位,供停泊屬於該地段上已建或擬建的建築物之住戶和他們的真正來賓、訪客或被邀請者的單車,使署長滿意。按本特別條款提供的每個車位不得用作停泊屬於該地段上已建或擬建的建築物之住戶和他們的真正來賓、訪客或被邀請者的單車以外的任何用途。」

**16. 批地文件特別條款第(29)條**

「(a) 即使已遵守與履行此等條款使署長滿意，住宅停車位及電單車停車位不得：

(i) 轉讓，除非

(I) 連同賦予專屬使用與管有該地段上已建或擬建的一座或多座建築物之一個或多個住宅單位的權利的不分割份數一併轉讓；或

(II) 轉讓予現時為具專屬使用與管有該地段上已建或擬建的一座或多座建築物之一個或多個住宅單位的權利的不分割份數的擁有人；或

(ii) 分租，租予該地段上已建或擬建的一座或多座建築物之住宅單位的住客除外。

惟於任何情況下，不得轉讓多過合共三個住宅停車位及電單車停車位予該地段上已建或擬建的一座或多座建築物之任何一個住宅單位的擁有人或分租予任何一個住宅單位的住客。」

**17. 批地文件特別條款第(30)條**

「該地段內根據特別條款第(24)(a)(iii)(可按特別條款第(27)條更改)、(25)(a)及(26)條提供的停車位須被指定為並構成公用地方的一部份。」

**18. 批地文件特別條款第(31)條**

「經署長批准及存放於署長的車位佈局圖則上標示的泊車、上落貨車位不得用於特別條款第(24)、(25)及(26)條分別所列明之外的用途。購買人須根據上述經批准圖則對泊車、上落貨車位及其他地方(包括但不限於電梯、升降台、移動空間及通道地方)進行保養，且除非得到署長的事先書面同意，不得更改其佈局。除上述經批准圖則標示的停車位外，該地段任何部份或其上的任何建築物或構築物不得用作泊車用途。」

**19. 批地文件特別條款第(33)條**

「購買人不得切割、移走或後移該地段毗鄰或毗連的任何政府土地或在任何政府土地上進行任何類型的堆積、堆填或任何斜坡處理工程，特別條款第(37)條允許或署長預先書面批准者除外，署長可以自行酌情給予同意，施加他認為合適的條款及條件，包括按他可決定的地價授予額外的政府土地作為該地段的延伸段。」

**20. 批地文件特別條款第(34)條**

「(a) 如果任何土地需要或已經被削土、移除或後移或堆積或堆填或進行任何類型的斜坡處理工程，不論有否經署長預先書面同意，亦不論是在該地段內或任何政府土地上，其進行旨在或有關構建、平整或發展該地段或其中任何部份或購買人按此等條款要求進行的任何其他工程或作任何其他用途，購買人須自費進行與建造該等斜坡處理工程、護土牆或其他支撐物、保護物、排水或輔助工程或當時或今後任何時候為保護與支撐該地段和任何毗鄰或毗連政府土地或出租土地內的土地及避免與防止今後發生任何塌方、山泥傾瀉或地陷之必要工程。購買人須在同意批租年期期間所有時候自費保養上述土地、斜坡處理工程、護土牆或其他支撐物、保護物、排水或輔助工程或其他工程，使其處於修葺良好堅固的狀態，使署長滿意。」

(c) 倘若因為或出於任何構建、平整、發展或購買人進行的其他工程或任何其他原因造成任何時候發生任何塌方、山泥傾瀉或地陷，不論發生在或來自該地段或任何毗鄰或毗連政府土地或出租土地的任何土地，購買人須自費進行修復及彌補，使署長滿意並對不論直接或間接因該等塌方、山泥傾瀉或地陷而令政府、其代理人及承辦商承受、遭受或產生的一切費用、收費、損害、要求及索償作出彌償。」

(d) 除了此處規定對違反任何此等條款的任何其他權利或濟助外，署長有權發出書面通知要求購買人進行、建造及保養所述土地、斜坡處理工程、護土牆或其他支撐物、保護物及排水或輔助工程或其他工程或修復與彌補任何塌方、山泥傾瀉或地陷。如果購買人不理會或未能在通知指定的時期內遵守該通知，使署長滿意，署長可立即執行與進行任何必要工程，且購買人須在要求時歸還政府因此產生的費用連同任何行政費或專業費用及開支。」

**21. 批地文件特別條款第(36)條**

「如果在發展或重新發展該地段或其中任何部份時已安裝預應力地錨，購買人須自費在預應力地錨的服務年限期間進行預應力地錨的定期保養與定期檢查，使署長滿意並在署長不時全權酌情要求時提供所有該等檢查工程的報告和資料給署長。如果購買人不理會或未能進行所要求的檢查工程，署長可立即執行與進行該等檢查工程，且購買人須在要求時歸還政府因此產生的費用。」

**22. 批地文件特別條款第(37)條**

「(a) 購買人現確認及接受，該地段可能受來自該地段內及該地段外(為僅作識別用途)以綠色間斷邊綫顯示的範圍(以下簡稱「綠色間斷邊綫範圍」)因天然地形引致的山泥傾瀉和落石的危害所影響。」

(c) 在2026年3月31日或署長批准的其他日期之前，購買人須按照署長絕對酌情決定批准或要求的「經批准緩解建議書」(定義見批地文件特別條款第(37)(b)(ii)條)，在該地段(有關工程下文稱為「地段內工程」)及在綠色間斷邊綫範圍或任何其他政府土地(有關工程下文稱為「地段外工程」)進行該等緩解和鞏固工程及相關之工程，包括提供維修通道的工程，在一切方面令署長滿意。在地段內工程及地段外工程完成之前，不得讓任何住戶或佔用人和他們的真正來賓、訪客或受邀者佔用在「調查」(定義見批地文件特別條款第(37)(b)(i)條)中識別到可能受山泥傾瀉和落石的危害所影響的該地段內任何部份或在其上興建的建築物及構築物。」

(f) (i) 購買人在同意批租年期內一切時間須自費保養地段內工程及地段外工程，使其維持在良好和修繕妥當的狀況並確保地段內工程及地段外工程能繼續發揮其設定的作用，並在一切方面令署長滿意。保養工作包括但不限於清理下墜於地段內工程或地段外工程或在「天然山坡危害緩解和鞏固工程圖則」(定義見批地文件特別條款(37)(e)條)上所示的該土地或政府土地的山泥傾瀉殘骸和落石。」

(ii) 除政府對購買人違反按本文中規定保養地段內工程以及地段外工程的義務而針對購買人的任何權利和補救措施外，署長亦有權以書面通知要求購買人在署長絕對酌情決定認為適當的限期內進行該等保養工作。如購買人忽略或沒有在通知書訂明的限期內遵行有關要求並令署長滿意，署長可立即執行及進行所需的保養工作，購買人並須按政府償還該等工作的費用以及任何署長或其授權人士釐定的監督及間接費用，其釐定的結果為最終的並對購買人有約束力。」

(h) 如因進行「調查」或進行、視察、檢查、監督及保養地段內工程以及地段外工程而造成綠色間斷邊綫範圍或任何其他政府土地損毀，購買人須在署長決定的限期內自費修復該等損毀，並在一切方面令署長滿意。如購買人沒有在前述限期內履行本特別條款第(h)分條的義務，署長可立即執行並進行所需要的工程，購買人並須按政府償還該等工作的費用以及任何署長或其授權人士釐定的行政和專家費用和收費，其釐定的結果為最終的並對購買人有約束力。」

**23. 批地文件特別條款第(39)條**

「受制於特別條款第(40)條，購買人須在所有時候，尤其是在進行建築、保養、翻新或維修工程(下文稱為「該等工程」)期間，採取或促使他人採取一切適當及充分的關注、技巧及預防措施，避免對該地段、綠色範圍、綠色間斷邊綫範圍或他們任一的任何部份之上、上面、之下或毗鄰的任何政府或其他現有排水渠、水路或水道、總水喉、道路、行人徑、街道設施、污水渠、溝渠、管道、電纜、電線、公用事業服務或任何其他工程或裝置(下文統稱為「該等服務設施」)造成任何損害、干擾或妨礙。購買人在進行任何該等工程之前須進行或促使他人進行適當的勘測及必要的了解，確定任何該等服務設施的現有位置及水平，並就處理可能受到該等工程影響的任何該等服務設施提交書面建議給署長，供他於一切方面審批，且不得在取得署長對該等工程及建議作出的書面批准前進行任何工程。購買人須遵守及自費達到署長作出上述批准時就該等服務設施所施加的任何要求，包括任何必要之改道、重鋪或修復的費用。購買人必須自費及在一切方面維修、彌補及修復以任何方式因進行該等工程而對該地段、綠色範圍、綠色間斷邊綫範圍或其中任一的任何部份或任何該等服務設施造成的任何損害、干擾或妨礙(除了溝渠、污水渠、雨水渠或總水喉須由署長負責彌補，除非署長另作選擇，且購買人須在要求時向政府支付工程的費用)，使署長滿意。如果購買人未能對該地段、綠色範圍、綠色間斷邊綫範圍或其中任一的任何部份或任何該等服務設施進行任何該等必要的改道、重鋪、維修、彌補及修復，使署長滿意，署長可進行他認為必要的任何該等改道、重鋪、維修、彌補或修復，且購買人須在要求時向政府支付工程的費用。」

**24. 批地文件特別條款第(40)條**

「(a) 購買人現確認截至本合約之日，在該地段內存在屬於中華電力有限公司(下文稱為「中電」)的公用事業設施，為路政署及運輸署的設施提供公用事業服務，包括但不限於低壓電纜、木桿和架空線，其大概位置及對準綫為僅作識別用途在附錄的圖則上以紅色綫顯示(這些公用事業設施以下統稱「現有中電公用設施」)。

(d) 在2026年3月31日或署長批准的其他日期之前，購買人需自費並按照據本特別條款第(e)分條所批准的建議書及遵從署長在發出前述批准時可能施加的一切要求，將現有中電公用設施改道至署長批准或要求的該地段內的該(等)其他部份(下文稱為「現有中電公用設施改道工程」)，在一切方面令署長及中電滿意。」

**25. 批地文件特別條款第(41)條**

「(a) 購買人現確認截至本合約之日，該地段附近設有兩個墳墓，其為僅作識別用途在附錄的圖則上以「墳墓1」及「墳墓2」標示(以下統稱「現有墳墓」)。在行人通道(定義見本特別條款第(b)分條)完成興建並在一切方面使署長滿意之前，購買人需在所有合理時間內允許政府及所有公眾人士毋須支付任何性質的費用自由及免受干擾地徒步往返、沿著或穿過該地段內的該(等)路線來往現有墳墓，在一切方面令署長滿意。

(b) (i) 購買人須於2026年3月31日或署長批准的其他日期之前，自費按署長批准的位置、方式、物料、標準、水平、定線及設計在該地段內鋪設、構建、提供、建造及鋪面一條或多條行人路或行人道(包括署長有絕對酌情權要求的一切樓梯、坡道和照明設施)(以下簡稱「行人路」)往返現有墳墓，在一切方面令署長滿意。

(ii) 行人路完工後，購買人須在同意批租年期的所有合理時間內准許公眾人士毋須支付任何性質的費用自由及免受干擾地徒步經過、沿經或穿越行人路，以通行、出入及往返現有墳墓。

(c) 購買人須在同意批租年內自費保持及保養行人路，使其處於修葺良好堅固的狀態，在一切方面使署長滿意。

(e) 行人路應成為公用地方的一部份。」

**26. 批地文件特別條款第(42)條**

「(a) 購買人須自費建造與保養署長認為必要用作截斷與引導落在或流到該地段的一切暴雨或雨水到最近的河道、集水井、渠道或政府雨水渠的該等排水渠及渠道，不論在該地段的邊界內或政府土地上，且購買人須對上述暴雨或雨水造成的任何損害或滋擾而導致的一切訴訟、索償及要求自行負責並向政府及其辦公人員作出彌償。

(b) 連接該地段的任何排水渠和污水渠至政府的雨水渠及污水渠(如已鋪設及啟用)的工程可由署長進行，但署長毋須就因此產生的任何損失或損害對購買人負責，且購買人須在要求時向政府支付上述連接工程的費用，或者該等連接工程可以按署長滿意的方式由購買人自費進行，在該種情況下，上述連接工程的任何一段若在政府土地內建造，必須由購買人自費保養，並在要求時由購買人移交給政府，由政府出資負責將來之保養，且購買人須在要求時向政府支付有關上述連接工程的技術檢查之費用。若購買人未能保養在政府土地內建造的上述連接工程的任何一段，署長可進行其認為必要的該等保養工程，且購買人須在要求時向政府支付該等工程的費用。」

**27. 批地文件特別條款第(43)條**

「(b) 購買人須在環境保護署署長訂定的期限內自費進行及實施環境保護署署長批准的「排污影響評估」(定義見批地文件特別條款第(43)(a)條)的建議，在一切方面使環境保護署署長滿意。

(e) 為免存疑和在不影響一般條款第5條的一般性的原則下，購買人特此明文承認及同意他須獨自負責自費進行及實施環境保護署署長批准的「排污影響評估」的建議，在一切方面使環境保護署署長滿意。」

**28. 批地文件特別條款第(44)條**

「(b) 購買人須在渠務署署長訂定的期限內自費進行及實施渠務署署長批准的「排水影響評估」(定義見批地文件特別條款第(44)(a)條)的建議，在一切方面使渠務署署長滿意。

(e) 為免存疑和在不影響一般條款第5條的一般性的原則下，購買人特此明文承認及同意他須獨自負責自費進行及實施渠務署署長批准的排水影響評估的建議，在一切方面使渠務署署長滿意。」

**29. 批地文件特別條款第(45)條**

「(b) 購買人須在署長訂定的期限內自費進行與實施「噪音影響評估」(定義見批地文件特別條款第(45)(a)條)內建議並經署長批准的「噪音緩解措施」(下文稱為「經批准噪音緩解措施」)，在一切方面使署長滿意。

(d) 為免存疑和在不影響一般條款第5條的一般性的原則下，購買人特此明文承認及同意他須獨自負責自費進行及實施經批准噪音緩解措施，在一切方面使渠務署署長滿意。」

**30. 批地文件特別條款第(46)條**

「倘若經批准噪音緩解措施包括在該地段上搭建或建造伸展超出該地段的邊界和在毗鄰政府土地任何部份之上及上方的一個或多個隔音屏障(下文稱為「隔音屏障」)，下列條件適用：

(a) 購買人須按建築事務監督批准的圖則自費設計、搭建及建造隔音屏障，並在一切方面符合《建築物條例》、其下的任何規例及任何修訂法例；

- (c) 未經署長的預先書面批准，不得在隔音屏障或其中任何部份之處或之上作出或固定任何更改、增建、更換或連接；
- (d) 購買人須在所有時候自費維護、保養及維修隔音屏障或(如果署長批准)其任何替代，使之保持修葺良好堅固狀態，並在一切方面使署長滿意；
- (e) 隔音屏障不得用作隔音屏障以外之任何用途，且未經署長的預先書面同意，購買人不得使用或容許或允許他人使用隔音屏障或其中任何部份以作宣傳或展示任何標誌、通告或海報；
- (g) 購買人須在所有時候採取必要的預防措施，防止因為搭建、建造、存在、檢查、維修、保養、清潔、翻新、更換、更改、使用、拆除或移除隔音屏障或其任何部份，或在隔音屏障或其任何部份加設或加附任何物件，而對該地段毗鄰的任何政府土地和隔音屏障或進入或使用該地段毗鄰的任何政府土地和隔音屏障的任何人士或車輛造成任何損害或損傷；
- (h) 署長有權在任何時候全權酌情向購買人送達一封書面通知，要求購買人在書面通知日期及收到該書面通知起的六個曆月內拆除與移除伸展到政府土地上面的隔音屏障部份，不得作出任何更換。購買人須在上述書面通知訂定的期間內自費拆除與移除上述隔音屏障部份，在一切方面使署長滿意；
- (i) 倘若本特別條款下任何購買人責任未能履行，署長可進行必要的工程，且購買人須在接獲要求時向署長支付該等工程的費用，該金額由署長決定且為最終的並對購買人有約束力。

### 31. 批地文件特別條款第(47)條

- 「(b) 購買人須在規劃署署長訂定的期限內自費進行及實施規劃署署長批准的「空氣流通評估」(定義見批地文件特別條款第(47)(a)條)的建議，在一切方面使規劃署署長滿意。
- (d) 為免存疑和在不影響一般條款第5條的一般性的原則下，購買人特此明文承認及同意他須獨自負責自費進行及實施規劃署署長批准的空氣流通評估的建議，在一切方面使規劃署署長滿意。」

#### 備註：

1. 批地文件內提述的「購買人」指批地文件下的購買人，若文義許可或要求，亦包括其遺囑執行人、遺產管理人及受讓人；如果是法團，包括它的繼承人及受讓人。
2. 批地文件內提述的「署長」乃指地政總署署長。
3. 本批地文件的摘要使用的專有詞語具有批地文件內界定的相同意義。

**A. Facilities that are required under the land grant to be constructed and provided for the Government, or for public use**

## 1. Green Areas

Under Special Condition Nos.(3)(a)(i), (3)(a)(ii) and (4) of the Land Grant, the Purchaser shall on or before the 31<sup>st</sup> day of March 2022 or such other date as may be approved by the Director of Lands (“the Director”) construct a future public road with associated structures and utilities on the Green Areas (as defined in the Land Grant), and shall at all reasonable times while in possession of the Green Areas allow free access for all Government and public vehicular and pedestrian traffic.

Relevant Provisions in the Land GrantSpecial Condition No.(3) of the Land Grant

“(a) The Purchaser shall:

- (i) on or before the 31<sup>st</sup> day of March 2022 or such other date as may be approved by the Director, at the Purchaser’s own expense, in such manner with such materials and to such standards, levels, alignment and design as the Director shall approve and in all respects to the satisfaction of the Director:

- (I) lay and form that portion of future public road shown coloured green on the plan annexed hereto (hereinafter referred to as “the Green Areas”); and

- (II) provide and construct within the Green Areas such bridges, tunnels, over-passes, under-passes, culverts, viaducts, flyovers, pavements, roads or such other structures as the Director in his sole discretion may require (hereinafter collectively referred to as “the Structures”)

so that building, vehicular and pedestrian traffic may be carried on the Green Areas;

- (ii) on or before the 31<sup>st</sup> day of March 2022 or such other date as may be approved by the Director, at the Purchaser’s own expense and to the satisfaction of the Director, surface, kerb and channel the Green Areas and provide the same with such gullies, sewers, drains, fire hydrants with pipes connected to water mains, street lights, traffic signs, street furniture and road markings as the Director may require; and

- (iii) maintain at the Purchaser’s own expense the Green Areas together with the Structures and all structures, surfaces, gullies, sewers, drains, fire hydrants, services, street lights, traffic signs, street furniture, road markings and plant constructed, installed and provided thereon or therein to the satisfaction of the Director until such time as possession of the Green Areas has been delivered in accordance with Special Condition No.(4) hereof.

- (b) In the event of the non-fulfilment of the Purchaser’s obligations under sub-clause (a) of this Special Condition by the date specified therein or such other date as may be approved by the Director, the Government may carry out the necessary works at the cost of the Purchaser who shall pay to the Government on demand a sum equal to the cost thereof, such sum to be determined by the Director whose determination shall be final and binding upon the Purchaser.”

Special Condition No.(4) of the Land Grant

“For the purpose only of carrying out the works specified in Special Condition No.(3) hereof, the Purchaser shall on the date of this Agreement be granted possession of the Green Areas. The Green Areas shall be re-delivered to the Government on demand and in any event shall be deemed to have been re-delivered to the Government by the Purchaser on the date of a letter from the Director indicating that these Conditions have been complied with to his satisfaction. The Purchaser shall at all reasonable times while he is in possession of the Green Areas allow free access over and along the Green Areas for all Government and public vehicular and pedestrian traffic and shall ensure that such access shall not be interfered with or obstructed by the carrying out of the works whether under Special Condition No.(3) hereof or otherwise.”

Special Condition No.(6) of the Land Grant

“(a) The Purchaser shall at all reasonable times while he is in possession of the Green Areas:

- (ii) permit the Government and the relevant public utility companies authorized by the Government with or without tools, equipment, plant, machinery or motor vehicles, free of charge the right of free and uninterrupted ingress, egress and regress to, from and through the lot and the Green Areas as the Government or the relevant public utility companies may require for the purpose of any works to be carried out in, upon or under the Green Areas or any adjoining land including but not limited to the laying and subsequent maintenance of all pipes, wire, conduits, cable-ducts and other conducting media and ancillary equipment necessary for the provision of telephone, electricity, gas (if any) and other services intended to serve the lot or any adjoining or neighbouring land or premises, and the Purchaser shall co-operate fully with the Government and also with the relevant public utility companies authorized by the Government on all matters relating to any of the aforesaid works to be carried out within the Green Areas; and

- (iii) permit the officers of the Water Authority and such other persons as may be authorized by them with or without tools, equipment, plant, machinery or motor vehicles, free of charge the right of free and uninterrupted ingress, egress and regress to, from and through the lot and the Green Areas as the officers of the Water Authority or such authorized persons may require for the purpose of carrying out any works in relation to the operation, maintenance, repairing, replacement and alteration of any other waterworks installations within the Green Areas.”

Relevant Provisions in the Deed of Mutual Covenant

Not applicable.

## 2. Pedestrian Walkway

Under Special Condition Nos.(41)(a) and (41)(b)(i) of the Land Grant, the Purchaser shall on or before the 31<sup>st</sup> day of March 2026 or such other date as may be approved by the Director, lay, form, provide, construct and surface pedestrian walkway(s) (together with stairs, ramps and lightings as may be required) within the lot to and from the Existing Graves (as defined in the Land Grant) near the lot, and shall at all reasonable times permit free and interrupted access on foot by the Government and all members of the public.



Relevant Provisions in the Land Grant

Special Condition No.(41) of the Government Grant

- “(a) The Purchaser hereby acknowledges that as at the date of this Agreement, there are two graves near the lot, which are for identification purpose only shown and marked “Grave 1” and “Grave 2” respectively on the plan annexed hereto (hereinafter collectively referred to as “the Existing Graves”). Before the Pedestrian Walkway (as defined in sub-clause (b) of this Special Condition) has been completed in all respects to the satisfaction of the Director, the Purchaser shall at all reasonable times permit the Government and all members of the public to have free and uninterrupted access and without payment of any nature whatsoever to pass and repass on foot on, along or through such route within the lot to and from the Existing Graves in all respects to the satisfaction of the Director.
- (b) (i) The Purchaser shall on or before the 31<sup>st</sup> day of March, 2026 or such other date as may be approved by the Director at his own expense and in all respects to the satisfaction of the Director lay, form, provide, construct and surface a pedestrian walkway or walkways, or a footpath or footpaths (together with such stairs, ramps and lightings as the Director at his absolute discretion may require) within the lot (hereinafter referred to as “the Pedestrian Walkway”) to and from the Existing Graves at such position, in such manner, with such materials and to such standards, levels, alignment and designs as the Director shall approve.
- (ii) Upon completion of the Pedestrian Walkway, the Purchaser shall at all reasonable times throughout the term hereby agreed to be granted permit all members of the public to have free and uninterrupted access and without payment of any nature whatsoever to pass and repass on foot on, along or through the Pedestrian Walkway to and from the Existing Graves.
- (c) The Purchaser shall throughout the term hereby agreed to be granted at his own expense keep and maintain the Pedestrian Walkway in good and substantial repair and condition in all respects to the satisfaction of the Director.
- (e) The Pedestrian Walkway shall be designated as and form part of the Common Areas.”

Relevant Provisions in the Deed of Mutual Covenant

Definitions in Recital (1)(a)

Definition of “Development Common Areas”

“The whole of the Lot and the Development which are not otherwise specifically assigned to or for the exclusive use of an Owner and are designed or intended for common use and benefit of the Owners (which do not form part of the Units, Residential Common Areas or Car Park Common Areas) and shall include but not limited to CLP cable pits, CLP maintenance accesses, the Pedestrian Walkway, driveways and ramps (which do not form part of the Car Park Common Areas or Residential Common Areas), civil drains, manholes, part of the emergency vehicular access (which do not form part of the Residential Common Areas), boundary/fence walls, part of the Slope and Retaining Structures (which do not form part of the Residential Common Areas), telecommunications and broadcasting equipment rooms (which do not form part of the Residential Common Areas), mobile equipment room, master water

meter rooms, sprinkler water tank and pump rooms (which do not form part of the Residential Common Areas), fire services water tank and pump rooms (which do not form part of the Residential Common Areas), potable water tank and pump rooms (which do not form part of the Residential Common Areas), flushing water tank and pump rooms (which do not form part of the Residential Common Areas), potable and flushing water tank and pump rooms (which do not form part of the Residential Common Areas), water meter cabinets (which do not form part of the Residential Common Areas), staircases (which do not form part of the Units, Car Park Common Areas or Residential Common Areas), caretaker’s offices, street fire hydrant tank and pump rooms, street fire hydrant transfer tank and pump rooms, pipe ducts (which do not form part of the Residential Common Areas), smoke lobbies (which do not form part of the Car Park Common Areas or Residential Common Areas), service corridor (which do not form part of the Residential Common Areas), switch rooms, basement screen walls, cavity wall(s) (which do not form part of the Car Park Common Areas or Residential Common Areas), footpaths and passageways, common flat roofs (which do not form part of the Residential Common Areas), guard room(s), transformer rooms, transformer room lobby, ventilation duct for transformer room, cable riser room, electrical ducts (which do not form part of the Residential Common Areas), fire control centre, cabinets for fire services inlets and valves (which do not form part of the Residential Common Areas), refuse storage and material recovery chambers, generator rooms and all other common parts specified in Schedule 1 to the Ordinance (if any) within the Lot and the Development designed or intended for common use and benefit of the Owners and not otherwise specifically assigned to or for the exclusive use of an Owner (which do not form part of the Units, Residential Common Areas and Car Park Common Areas). The Development Common Areas are for the purpose of identification only shown and coloured Yellow on the plans (certified as to their accuracy by the Authorized Person) hereto annexed”.

Definition of “Pedestrian Walkway”

“The pedestrian walkway as referred to in Special Condition (41)(b)(i) of the Government Grant”.

Clause (3:02:01)(bc)

“Save and except as otherwise expressly provided in this Deed, the Manager shall be responsible for and shall have full authority to do all such acts and things as may be necessary or requisite for and in connection with the proper and efficient management of the Development, including in particular but without in any way limiting the generality of the foregoing :-

- (bc) without prejudice to the generality of any provision herein contained, to keep and maintain the Pedestrian Walkway in good and substantial repair and condition and in all respects to the satisfaction of the Director of Lands;”

Paragraph (3) of the Third Schedule

- “(3) Notwithstanding any terms contained herein to the contrary, the Undivided Shares of and in the Lot and the Development and the exclusive right to hold use occupy and enjoy each Unit shall be further subject to the following :-
- (a) The right for the Government, its officers and any persons authorised by it or them from time to time and all members of the public to at all reasonable times have free and uninterrupted access and without payment of any nature whatsoever to pass and repass on foot on, along or through such route within the Lot to and from the existing graves as referred to in

Special Condition No.(41)(a) of the Government Grant (“the Existing Graves”) in all respects to the satisfaction of the Director of Lands , until (i) the Pedestrian Walkway is completed in all respects to the satisfaction of the Director of Lands and (ii) all members of the public are permitted to have free and uninterrupted access and without payment of any nature whatsoever to pass and repass on foot on, along or through the Pedestrian Walkway in accordance with Special Condition No.(41)(b)(ii) of the Government Grant.

- (b) The right for all members of the public to at all reasonable times have free and uninterrupted access and without payment of any nature whatsoever to pass and repass on foot on, along or through the Pedestrian Walkway to and from the Existing Graves.”

**B. Information on any facilities that are required under the land grant to be managed, operated or maintained for public use at the expense of the owners of the residential properties in the Phase**

1. Green Areas

Under Special Condition No.(3)(a)(iii) of the Land Grant, the Purchaser shall at his own expense maintain the Green Areas together with the future public road and associated structures and utilities thereon or therein until possession of the Green Areas has been delivered to the Government in accordance with Special Condition No.(4) of the Land Grant.

Relevant Provisions in the Land Grant

Special Condition No.(3) of the Land Grant

“(a) The Purchaser shall:

- (i) on or before the 31<sup>st</sup> day of March 2022 or such other date as may be approved by the Director, at the Purchaser’s own expense, in such manner with such materials and to such standards, levels, alignment and design as the Director shall approve and in all respects to the satisfaction of the Director:
- (I) lay and form that portion of future public road shown coloured green on the plan annexed hereto (hereinafter referred to as “the Green Areas”); and
- (II) provide and construct within the Green Areas such bridges, tunnels, over-passes, under-passes, culverts, viaducts, flyovers, pavements, roads or such other structures as the Director in his sole discretion may require (hereinafter collectively referred to as “the Structures”)

so that building, vehicular and pedestrian traffic may be carried on the Green Areas;

- (ii) on or before the 31<sup>st</sup> day of March 2022 or such other date as may be approved by the Director, at the Purchaser’s own expense and to the satisfaction of the Director, surface, kerb and channel the Green Areas and provide the same with such gullies, sewers, drains, fire hydrants with pipes connected to water mains, street lights, traffic signs, street furniture and road markings as the Director may require; and

- (iii) maintain at the Purchaser’s own expense the Green Areas together with the Structures and all structures, surfaces, gullies, sewers, drains, fire hydrants, services, street lights, traffic signs, street furniture, road markings and plant constructed, installed and provided thereon or therein to the satisfaction of the Director until such time as possession of the Green Areas has been delivered in accordance with Special Condition No.(4) hereof.

- (b) In the event of the non-fulfilment of the Purchaser’s obligations under sub-clause (a) of this Special Condition by the date specified therein or such other date as may be approved by the Director, the Government may carry out the necessary works at the cost of the Purchaser who shall pay to the Government on demand a sum equal to the cost thereof, such sum to be determined by the Director whose determination shall be final and binding upon the Purchaser.”

Special Condition No.(4) of the Land Grant

“For the purpose only of carrying out the works specified in Special Condition No.(3) hereof, the Purchaser shall on the date of this Agreement be granted possession of the Green Areas. The Green Areas shall be re-delivered to the Government on demand and in any event shall be deemed to have been re-delivered to the Government by the Purchaser on the date of a letter from the Director indicating that these Conditions have been complied with to his satisfaction. The Purchaser shall at all reasonable times while he is in possession of the Green Areas allow free access over and along the Green Areas for all Government and public vehicular and pedestrian traffic and shall ensure that such access shall not be interfered with or obstructed by the carrying out of the works whether under Special Condition No.(3) hereof or otherwise.”

Special Condition No.(6) of the Land Grant

“(a) The Purchaser shall at all reasonable times while he is in possession of the Green Areas:

- (ii) permit the Government and the relevant public utility companies authorized by the Government with or without tools, equipment, plant, machinery or motor vehicles, free of charge the right of free and uninterrupted ingress, egress and regress to, from and through the lot and the Green Areas as the Government or the relevant public utility companies may require for the purpose of any works to be carried out in, upon or under the Green Areas or any adjoining land including but not limited to the laying and subsequent maintenance of all pipes, wire, conduits, cable-ducts and other conducting media and ancillary equipment necessary for the provision of telephone, electricity, gas (if any) and other services intended to serve the lot or any adjoining or neighbouring land or premises, and the Purchaser shall co-operate fully with the Government and also with the relevant public utility companies authorized by the Government on all matters relating to any of the aforesaid works to be carried out within the Green Areas; and
- (iii) permit the officers of the Water Authority and such other persons as may be authorized by them with or without tools, equipment, plant, machinery or motor vehicles, free of charge the right of free and uninterrupted ingress, egress and regress to, from and through the lot and the Green Areas as the officers of the Water Authority or such authorized persons may require for the purpose of carrying out any works in relation to the operation, maintenance, repairing, replacement and alteration of any other waterworks installations within the Green Areas.”

Relevant Provisions in the Deed of Mutual Covenant

Not applicable.

2. Pedestrian Walkway

Under Special Condition No.(41)(c) of the Land Grant, the Purchaser shall at his own expense keep and maintain the Pedestrian Walkway in good and substantial repair and condition in all respects to the satisfaction of the Director.

Relevant Provisions in the Land Grant

Special Condition No.(41) of the Government Grant

- “(a) The Purchaser hereby acknowledges that as at the date of this Agreement, there are two graves near the lot, which are for identification purpose only shown and marked “Grave 1” and “Grave 2” respectively on the plan annexed hereto (hereinafter collectively referred to as “the Existing Graves”). Before the Pedestrian Walkway (as defined in sub-clause (b) of this Special Condition) has been completed in all respects to the satisfaction of the Director, the Purchaser shall at all reasonable times permit the Government and all members of the public to have free and uninterrupted access and without payment of any nature whatsoever to pass and repass on foot on, along or through such route within the lot to and from the Existing Graves in all respects to the satisfaction of the Director.
- (b) (i) The Purchaser shall on or before the 31<sup>st</sup> day of March, 2026 or such other date as may be approved by the Director at his own expense and in all respects to the satisfaction of the Director lay, form, provide, construct and surface a pedestrian walkway or walkways, or a footpath or footpaths (together with such stairs, ramps and lightings as the Director at his absolute discretion may require) within the lot (hereinafter referred to as “the Pedestrian Walkway”) to and from the Existing Graves at such position, in such manner, with such materials and to such standards, levels, alignment and designs as the Director shall approve.
- (iii) Upon completion of the Pedestrian Walkway, the Purchaser shall at all reasonable times throughout the term hereby agreed to be granted permit all members of the public to have free and uninterrupted access and without payment of any nature whatsoever to pass and repass on foot on, along or through the Pedestrian Walkway to and from the Existing Graves.
- (c) The Purchaser shall throughout the term hereby agreed to be granted at his own expense keep and maintain the Pedestrian Walkway in good and substantial repair and condition in all respects to the satisfaction of the Director.
- (e) The Pedestrian Walkway shall be designated as and form part of the Common Areas.”

Relevant Provisions in the Deed of Mutual Covenant

Definitions in Recital (1)(a)

Definition of “Development Common Areas”

“The whole of the Lot and the Development which are not otherwise specifically assigned to or for the exclusive use of an Owner and are designed or intended for common use and benefit of the Owners (which do not form part of the Units, Residential Common Areas or Car Park Common Areas) and shall include but not limited to CLP cable pits, CLP maintenance accesses, the Pedestrian Walkway, driveways and ramps (which do not form part of the Car Park Common Areas or Residential Common Areas)), civil drains, manholes, part of the emergency vehicular access (which do not form part of the Residential Common Areas), boundary/fence walls, part of the Slope and Retaining Structures (which do not form part of the Residential Common Areas), telecommunications and broadcasting equipment rooms (which do not form part of the Residential Common Areas), mobile equipment room, master water meter rooms, sprinkler water tank and pump rooms (which do not form part of the Residential Common Areas), fire services water tank and pump rooms (which do not form part of the Residential Common Areas), potable water tank and pump rooms (which do not form part of the Residential Common Areas), flushing water tank and pump rooms (which do not form part of the Residential Common Areas), potable and flushing water tank and pump rooms (which do not form part of the Residential Common Areas), water meter cabinets (which do not form part of the Residential Common Areas), staircases (which do not form part of the Units, Car Park Common Areas or Residential Common Areas), caretaker’s offices, street fire hydrant tank and pump rooms, street fire hydrant transfer tank and pump rooms, pipe ducts (which do not form part of the Residential Common Areas), smoke lobbies (which do not form part of the Car Park Common Areas or Residential Common Areas), service corridor (which do not form part of the Residential Common Areas), switch rooms, basement screen walls, cavity wall(s) (which do not form part of the Car Park Common Areas or Residential Common Areas), footpaths and passageways, common flat roofs (which do not form part of the Residential Common Areas), guard room(s), transformer rooms, transformer room lobby, ventilation duct for transformer room, cable riser room, electrical ducts (which do not form part of the Residential Common Areas), fire control centre, cabinets for fire services inlets and valves (which do not form part of the Residential Common Areas), refuse storage and material recovery chambers, generator rooms and all other common parts specified in Schedule 1 to the Ordinance (if any) within the Lot and the Development designed or intended for common use and benefit of the Owners and not otherwise specifically assigned to or for the exclusive use of an Owner (which do not form part of the Units, Residential Common Areas and Car Park Common Areas). The Development Common Areas are for the purpose of identification only shown and coloured Yellow on the plans (certified as to their accuracy by the Authorized Person) hereto annexed”.

Definition of “Pedestrian Walkway”

“The pedestrian walkway as referred to in Special Condition (41)(b)(i) of the Government Grant”.

Clause (3:02:01)(bc)

“Save and except as otherwise expressly provided in this Deed, the Manager shall be responsible for and shall have full authority to do all such acts and things as may be necessary or requisite for and in connection with the proper and efficient management of the Development, including in particular but without in any way limiting the generality of the foregoing :-

- (bc) without prejudice to the generality of any provision herein contained, to keep and maintain the Pedestrian Walkway in good and substantial repair and condition and in all respects to the satisfaction of the Director of Lands;”

Paragraph (3) of the Third Schedule

“(3) Notwithstanding any terms contained herein to the contrary, the Undivided Shares of and in the Lot and the Development and the exclusive right to hold use occupy and enjoy each Unit shall be further subject to the following :-

- (a) The right for the Government, its officers and any persons authorised by it or them from time to time and all members of the public to at all reasonable times have free and uninterrupted access and without payment of any nature whatsoever to pass and repass on foot on, along or through such route within the Lot to and from the existing graves as referred to in Special Condition No.(41)(a) of the Government Grant (“the Existing Graves”) in all respects to the satisfaction of the Director of Lands , until (i) the Pedestrian Walkway is completed in all respects to the satisfaction of the Director of Lands and (ii) all members of the public are permitted to have free and uninterrupted access and without payment of any nature whatsoever to pass and repass on foot on, along or through the Pedestrian Walkway in accordance with Special Condition No.(41)(b)(ii) of the Government Grant.
- (b) The right for all members of the public to at all reasonable times have free and uninterrupted access and without payment of any nature whatsoever to pass and repass on foot on, along or through the Pedestrian Walkway to and from the Existing Graves.”

**C Size of any open space that is required under the land grant to be managed, operated or maintained for public use at the expense of the owners of the residential properties in the Phase**

Not applicable.

**D. Any part of the land (on which the Phase is situated) that is dedicated to the public for the purposes of regulation 22(1) of the Building (Planning) Regulations (Cap 123 sub. leg. F)**

Not applicable.

In relation the facilities and open spaces, and those parts of the land, mentioned in Parts A, B, C and D above that are for public use, the general public has the right to use the facilities or open spaces, or the parts of the land, in accordance with the land grant or the deed of dedication (as the case may be).

In relation to the facilities and open spaces mentioned in Parts B or C above, (i) the facilities or open spaces are required to be managed, operated or maintained at the expense of the owners of the residential properties in the Phase, and (ii) those owners are required to meet a proportion of the expense of managing, operating or maintaining the facilities or open spaces through the management expenses apportioned to the residential properties concerned.

## A. 根據批地文件規定須興建並提供予政府或供公眾使用的任何設施

## 1. 綠色範圍

根據批地文件特別條款第(3)(a)(i)、第(3)(a)(ii)及第(4)條，購買人須於2023年3月31日或地政總署署長(「署長」)批准的其他日期之前在「綠色範圍」(在批地文件中定義)建造一條未來公共道路，並須在管有「綠色範圍」期間的所有合理時間准許所有政府及公共車輛及行人交通自由進入、通過及經過。

批地文件的有關條款批地文件特別條款第(3)條

「(a) 購買人須：

- (i) 於2022年3月31日或署長批准的其他日期之前按署長批准的方式、材料、標準、水平、定線及設計自費並在一切方面使署長滿意：
  - (I) 鋪設及構建於附錄的圖則上用綠色顯示的未來公共道路之部份(以下簡稱「綠色範圍」)；及
  - (II) 提供及建造按署長可全權酌情決定要求之橋樑、隧道、立交橋、地下通道、暗渠、高架橋、天橋、行人路、道路或其他構築物(以下統稱「該等構築物」)
 使建築物、車輛及行人往來可於綠色範圍進行；
- (ii) 於2022年3月31日或署長可批准的其他日期之前，自費在綠色範圍鋪設路面、路緣及渠道，並為其提供署長可能要求的明渠、污水渠、排水渠、消防龍頭連同接駁至總喉的喉管、街燈、交通標誌、街道設施及道路標記，使署長滿意；及
- (iii) 自費保養綠色範圍連同該等構築物以及在其之上或之內興建、設置及提供的所有構築物、路面、明渠、污水渠、排水渠、消防龍頭、服務、街燈、交通標誌、街道設施、道路標記及植物，使署長滿意，直至按特別條款第(4)條交還綠色範圍的管有權給政府。

(b) 倘若購買人未能在本特別條款第(a)分條指定的日期或署長可批准的其他日期之前履行本特別條款第(a)分條下的責任，政府可進行必要的工程，費用由購買人承擔。購買人須在接獲要求時向政府支付相等於該工程費用的金額，該金額由署長決定，其決定為最終決定並對購買人有約束力。」

批地文件特別條款第(4)條

「僅為進行本特別條款第(3)條指明的工程，購買人將自本合約之日獲授予綠色範圍的管有權。綠色範圍將須在政府要求下交還予政府，而在任何情況下，自署長發出信件指本批地條款已獲符合並使用其滿意之日，綠色範圍須當作已由購買人交還予政府。購買人須於所有合理時間在其管有綠色範圍或任何部份期間，准許所有政府及公共車輛及行人車輛交通自由進入、通過及經過綠色範圍，並確保該項進入的權利不受進行的工程干擾或阻礙，不論是按照批地文件的特別條款第(3)條或其他規定進行的工程。」

批地文件特別條款第(6)條

「(a) 購買人須在管有綠色範圍期間的所有合理時間：

- (ii) 准許政府及政府授權的有關公用事業公司携同或不携同工具、設備、機器、機械或車輛，有權免費自由及免受干擾地進入、離開及再進入其要求的該地段及綠色範圍，以在綠色範圍或任何毗鄰土地之內、之上或之下進行任何工程，包括但不限於鋪設及隨後維修所有擬為該地段或其他毗鄰土地或樓宇供應電話、電力、煤氣(如有)及其他服務必須的喉管、電纜、管道、纜槽及其他傳導媒介及輔助設備，購買人並須就在綠色範圍內進行的上述工程的一切事項，與政府及政府授權的有關公用事業公司全面合作；及
- (iii) 准許水務處的人員及其授權的其他該等人士携同或不携同工具、設備、機器、機械或車輛，有權免費自由及免受干擾地進入、離開及再進入其要求的該地段及綠色範圍，以在綠色範圍內進行任何有關運作、保養、維修、更換及更改任何其他水務裝置的工程。」

公契的有關條款

不適用。

## 2. 行人路

根據批地文件特別條款第(41)(a)及第(41)(b)(i)條，購買人須於2026年3月31日或地政總署署長(「署長」)批准的其他日期之前在該地段內鋪設、構建、提供、建造及鋪面一條或多條行人路或行人道(包括被要求的一切樓梯、坡道和照明設施)以進出該地段附近的「現有墳墓」(在批地文件中定義)，並在所有合理時間內准許政府及公眾人士自由及免受干擾地徒步進出。

批地文件的有關條款批地文件特別條款第(41)條

「(a) 購買人現確認截至本合約之日，該地段附近設有兩個墳墓，其為僅作識別用途在附錄的圖則上以「墳墓1」及「墳墓2」標示(以下統稱「現有墳墓」)。在行人通道(定義見本特別條款第(b)分條)完成興建並在一切方面使署長滿意之前，購買人須在所有合理時間內允許政府及所有公眾人士毋須支付任何性質的費用自由及免受干擾地徒步往返、沿著或穿過該地段內的該(等)路線來往現有墳墓，在一切方面令署長滿意。

- (b) (i) 購買人須於2026年3月31日或署長批准的其他日期之前，自費按署長批准的位置、方式、物料、標準、水平、定線及設計在該地段內鋪設、構建、提供、建造及鋪面一條或多條行人路或行人道(包括署長有絕對酌情權要求的一切樓梯、坡道和照明設施)(以下簡稱「行人路」)，在一切方面令署長滿意。
- (ii) 行人路完工後，購買人須在同意批租年期的所有合理時間內准許公眾人士毋須支付任何性質的費用自由及免受干擾地徒步經過、沿經或穿越行人路，以通行、出入及往返現有墳墓。

(c) 購買人須在同意批租年期內自費保持及保養行人路，使其處於修葺良好堅固的狀態，在一切方面使署長滿意。

(e) 行人路應成為「公用地方」的一部份。」

公契的有關條款敘文(1)(a)之定義部份「發展項目公用地方」的定義

「設計或擬供業主公用及共享，而非特別轉讓給或供個別業主獨家使用的整個該地段及發展項目（不構成單位、住宅公用地方或停車場公用地方一部份者），包括但不限於中電電纜井道、中電維修出入口、行人通道、車道和坡道（不構成停車場公用地方或住宅公用地方一部份者）、民用排水渠、人孔、部份緊急車輛通道（不構成住宅公用地方一部份者）、邊界牆/圍牆、部份斜坡及護土構築物（不構成住宅公用地方一部份者）、電訊及廣播設備室（不構成住宅公用地方一部份者）、流動設備房、主水錶房、花灑水箱和泵房（不構成住宅公用地方一部份者）、消防水箱和泵房（不構成住宅公用地方一部份者）、飲用水箱和泵房（不構成住宅公用地方一部份者）、沖廁水箱和泵房（不構成住宅公用地方一部份者）、飲用和沖廁水箱和泵房（不構成住宅公用地方一部份者）、水錶櫃（不構成住宅公用地方一部份者）、樓梯（不構成單位、停車場公用地方或住宅公用地方一部份者）、管理員辦公室、街道消防栓水箱和泵房、街道消防栓轉運水箱和泵房、管槽（不構成住宅公用地方一部份者）、防煙大堂（不構成停車場公用地方或住宅公用地方一部份者）、服務走廊（不構成住宅公用地方一部份者）、掣房、地庫分隔牆、空心牆（不構成停車場公用地方或住宅公用地方一部份者）、人行道和通道、公用平台（不構成住宅公用地方一部份者）、警衛室、變壓器房、變壓器房大堂、變壓器房通風管道、電纜豎管房、電槽（不構成住宅公用地方一部份者）、消防控制中心、消防入水口及閩櫃（不構成住宅公用地方一部份者）、垃圾儲存及物料回收室、發電機房以及在《建築物管理條例》（第344章）附表1指明的設計或擬供業主公用及共享而非特別轉讓給或供個別業主獨家使用的所有其他公用部份（如有）（不構成單位、停車場公用地方或住宅公用地方一部份者）。發展項目公用地方在本公契夾附的圖則（經認可人士核證為準）上以黃色顯示，僅供識別之用。」

「行人通道」的定義

「批地文件特別條款第(41)(b)(i)條提及的行人通道。」

第(3:02:01)(bc)條

「除本公契另有明文規定外，管理人須負責並具有充分授權作出與妥善及有效管理發展項目所必要或需要的一切行為及事情，在任何方面不限制上述一般適用範圍的前提下，特別是包括：

(bc) 在不限制上述任何條文一般適用範圍的前提下，保持及保養行人通道，使其處於修葺良好堅固的狀態，在一切方面使地政總署署長滿意；」

第三附表第(3)段

「(3) 儘管本公契另有任何相反條文，該地段及發展項目內的不分割份數，及專有持有、使用、佔用及享用各單位的權利，須進一步受以下所限：

(a) 政府、其人員及其不時授權的任何人士，及所有公眾人士，有權在所有合理時間內自由及免受干擾地，及毋須支付任何性質的費用，徒步往返、沿著或穿過該地段內的該（等）路線來往批地文件特別條款第(41)(a)條提述的現有墳墓（以下統稱「現有墳墓」），在一切方面令地政總署署長滿意，直至(i)行人通道完成興建並在一切方面令地政總署署長滿意；及(ii)按照批地文件特別條款第(41)(b)(ii)條，所有公眾人士獲准自由及免受干擾地，及毋須支付任何性質的費用，徒步經過、沿經或穿越行人通道。

(b) 公眾人士有權在所有合理時間內自由及免受干擾地，及毋須支付任何性質的費用，徒步經過、沿經或穿越行人通道，以進出現有墳墓。」

**B. 根據批地文件規定須由期數中的住宅物業的擁有人出資管理、營運或維持以供公眾使用的任何設施****1. 綠色範圍**

根據批地文件特別條款第(3)(a)(iii)條，購買人須自費保養「綠色範圍」連同未來公共道路及在其上或其內的所有相關構築物及公用服務，直至按批地文件特別條款第(4)條交還「綠色範圍」的管有權給政府。

批地文件的有關條款批地文件特別條款第(3)條

「(a) 購買人須：

(i) 於2023年3月31日或署長批准的其他日期之前按署長批准的方式、材料、標準、水平、定線及設計自費並在一切方面使署長滿意：

(I) 鋪設及構建於附錄的圖則上用綠色顯示的未來公共道路之部份（以下簡稱「綠色範圍」）；及

(II) 提供及建造按署長可全權酌情決定要求之橋樑、隧道、立交橋、地下通道、暗渠、高架橋、天橋、行人路、道路或其他構築物（以下統稱「該等構築物」）

使建築物、車輛及行人往來可於綠色範圍進行；

(ii) 於2023年3月31日或署長可批准的其他日期之前，自費在綠色範圍鋪設路面、路緣及渠道，並為其提供署長可能要求的明渠、污水渠、排水渠、消防龍頭連同接駁至總喉的喉管、街燈、交通標誌、街道設施及道路標記，使署長滿意；及

(iii) 自費保養綠色範圍連同該等構築物以及在其之上或之內興建、設置及提供的所有構築物、路面、明渠、污水渠、排水渠、消防龍頭、服務、街燈、交通標誌、街道設施、道路標記及植物，使署長滿意，直至按特別條款第(4)條交還綠色範圍的管有權給政府。

(b) 倘若購買人未能在本特別條款第(a)分條指定的日期或署長可批准的其他日期之前履行本特別條款第(a)分條下的責任，政府可進行必要的工程，費用由購買人承擔。購買人須在接獲要求時向政府支付相等於該工程費用的金額，該金額由署長決定，其決定為最終決定並對購買人有約束力。」

批地文件特別條款第(4)條

「僅為進行本特別條款第(3)條指明的工程，購買人將自本合約之日獲授予綠色範圍的管有權。綠色範圍將須在政府要求下交還予政府，而在任何情況下，自署長發出信件指本批地條款已獲符合並使用其滿意之日，綠色範圍須當作已由購買人交還予政府。購買人須於所有合理時間在其管有綠色範圍或任何部份期間，准許所有政府及公共車輛及行人車輛交通自由進入、通過及經過綠色範圍，並確保該項進入的權利不受進行的工程干擾或阻礙，不論是按照批地文件的特別條款第(3)條或其他規定進行的工程。」

批地文件特別條款第(6)條

「(a) 購買人須在管有綠色範圍期間的所有合理時間：

- (ii) 准許政府及政府授權的有關公用事業公司携同或不携同工具、設備、機器、機械或車輛，有權免費自由及免受干擾地進入、離開及再進入其要求的該地段及綠色範圍，以在綠色範圍或任何毗鄰土地之內、之上或之下進行任何工程，包括但不限於鋪設及隨後維修所有擬為該地段或其他毗鄰土地或樓宇供應電話、電力、煤氣(如有)及其他服務必須的喉管、電纜、管道、纜槽及其他傳導媒介及輔助設備，購買人並須就在綠色範圍內進行的上述工程的一切事項，與政府及政府授權的有關公用事業公司全面合作；及
- (iii) 准許水務處的人員及其授權的其他該等人士携同或不携同工具、設備、機器、機械或車輛，有權免費自由及免受干擾地進入、離開及再進入其要求的該地段及綠色範圍，以在綠色範圍內進行任何有關運作、保養、維修、更換及更改任何其他水務裝置的工程。」

公契的有關條款

不適用。

## 2. 行人路

根據批地文件特別條款第(41)(c)條，購買人須自費保持及保養行人路，使其處於修葺良好堅固的狀態，在一切方面使署長滿意。

批地文件的有關條款批地文件特別條款第(41)條

- 「(a) 購買人現確認截至本合約之日，該地段附近設有兩個墳墓，其為僅作識別用途在附錄的圖則上以「墳墓1」及「墳墓2」標示(以下統稱「現有墳墓」)。在行人通道(定義見本特別條款第(b)分條)完成興建並在一切方面使署長滿意之前，購買人需在所有合理時間內允許政府及所有公眾人士毋須支付任何性質的費用自由及免受干擾地徒步往返、沿著或穿過該地段內的該(等)路線來往現有墳墓，在一切方面令署長滿意。
- (b) (i) 購買人須於2026年3月31日或署長批准的其他日期之前，自費按署長批准的位置、方式、物料、標準、水平、定線及設計在該地段內鋪設、構建、提供、建造及鋪面一條或多條行人路或行人道(包括署長有絕對酌情權要求的一切樓梯、坡道和照明設施)(以下簡稱「行人路」)，在一切方面令署長滿意。
- (ii) 行人路完工後，購買人須在同意批租年期的所有合理時間內准許公眾人士毋須支付任何性質的費用自由及免受干擾地徒步經過、沿經或穿越行人路，以通行、出入及往返現有墳墓。
- (c) 購買人須在同意批租年期內自費保持及保養行人路，使其處於修葺良好堅固的狀態，在一切方面使署長滿意。
- (e) 行人路應成為「公用地方」的一部份。」

公契的有關條款敘文(1)(a)之定義部份「發展項目公用地方」的定義

「設計或擬供業主公用及共享，而非特別轉讓給或供個別業主獨家使用的整個該地段及發展項目(不構成單位、住宅公用地方或停車場公用地方一部份者)，包括但不限於中電電纜井道、中電維修出入口、行人通道、車道和坡道(不構成停車場公用地方或住宅公用地方一部份者)、民用排水渠、人孔、部份緊急車輛通道(不構成住宅公用地方一部份者)、邊界牆/圍牆、部份斜坡及護土構築物(不構成住宅公用地方一部份者)、電訊及廣播設備室(不構成住宅公用地方一部份者)、流動設備房、主水錶房、花灑水箱和泵房(不構成住宅公用地方一部份者)、消防水箱和泵房(不構成住宅公用地方一部份者)、飲用水箱和泵房(不構成住宅公用地方一部份者)、沖廁水箱和泵房(不構成住宅公用地方一部份者)、飲用和沖廁水箱和泵房(不構成住宅公用地方一部份者)、水錶櫃(不構成住宅公用地方一部份者)、樓梯(不構成單位、停車場公用地方或住宅公用地方一部份者)、管理員辦公室、街道消防栓水箱和泵房、街道消防栓轉運水箱和泵房、管槽(不構成住宅公用地方一部份者)、防煙大堂(不構成停車場公用地方或住宅公用地方一部份者)、服務走廊(不構成住宅公用地方一部份者)、掣房、地庫分隔牆、空心牆(不構成停車場公用地方或住宅公用地方一部份者)、人行道和通道、公用平台(不構成住宅公用地方一部份者)、警衛室、變壓器房、變壓器房大堂、變壓器房通風管道、電纜豎管房、電槽(不構成住宅公用地方一部份者)、消防控制中心、消防入水口及閘櫃(不構成住宅公用地方一部份者)、垃圾儲存及物料回收室、發電機房以及在《建築物管理條例》(第344章)附表1指明的設計或擬供業主公用及共享而非特別轉讓給或供個別業主獨家使用的所有其他公用部份(如有)(不構成單位、停車場公用地方或住宅公用地方一部份者)。發展項目公用地方在本公契夾附的圖則(經認可人士核證為準)上以黃色顯示，僅供識別之用。」

「行人通道」的定義

「批地文件特別條款第(41)(b)(i)條提及的行人通道。」

第(3:02:01)(bc)條

「除本公契另有明文規定外，管理人須負責並具有充分授權作出與妥善及有效管理發展項目所必要或需要的一切行為及事情，在任何方面不限制上述一般適用範圍的前提下，特別是包括：

- (bc) 在不限制上述任何條文一般適用範圍的前提下，保持及保養行人路，使其處於修葺良好堅固的狀態，在一切方面使地政總署署長滿意；」

第三附表第(3)段

「(3) 儘管本公契另有任何相反條文，該地段及發展項目內的不分割份數，及專有持有、使用、佔用及享用各單位的權利，須進一步受以下所限：

- (a) 政府、其人員及其不時授權的任何人士，及所有公眾人士，有權在所有合理時間內自由及免受干擾地，及毋須支付任何性質的費用，徒步往返、沿著或穿過該地段內的該(等)路線來往批地文件特別條款第(41)(a)條提述的現有墳墓(以下統稱「現有墳墓」)，在一切方面令地政總署署長滿意，直至(i)行人通道完成興建並在一切方面令地政總署署長滿意；及(ii)按照批地文件特別條款第(41)(b)(ii)條，所有公眾人士獲准自由及免受干擾地，及毋須支付任何性質的費用，徒步經過、沿經或穿越行人通道。

- (b) 公眾人士有權在所有合理時間內自由及免受干擾地，及毋須支付任何性質的費用，徒步經過、沿經或穿越行人通道，以進出現有墳墓。]

**C. 根據批地文件規定須由期數中的住宅物業的擁有人出資管理、營運或維持以供公眾使用的任何休憩用地的**大小

不適用。

**D. 期數所位於的土地中為施行《建築物(規劃)規例》(第123章，附屬法例F)第22(1)條而撥供公眾用途的任何部分**

不適用。



就以上 A、B、C 及 D 段所述的供公眾使用的設施及休憩用地，及土地中的該等部分，公眾有權按照批地文件或撥出私人地方供公眾使用的契據(視屬何情況而定)使用該等設施或休憩設施，或土地中的該等部分。

就以上 B 及 C 段提述的設施及休憩用地，(i) 該等設施或休憩用地按規定須由期數中的住宅物業的擁有人出資管理、營運或維持，而(ii) 該等擁有人按規定須以由有關住宅物業分攤的管理開支，應付管理、營運或維持該等設施或休憩用地的部分開支。

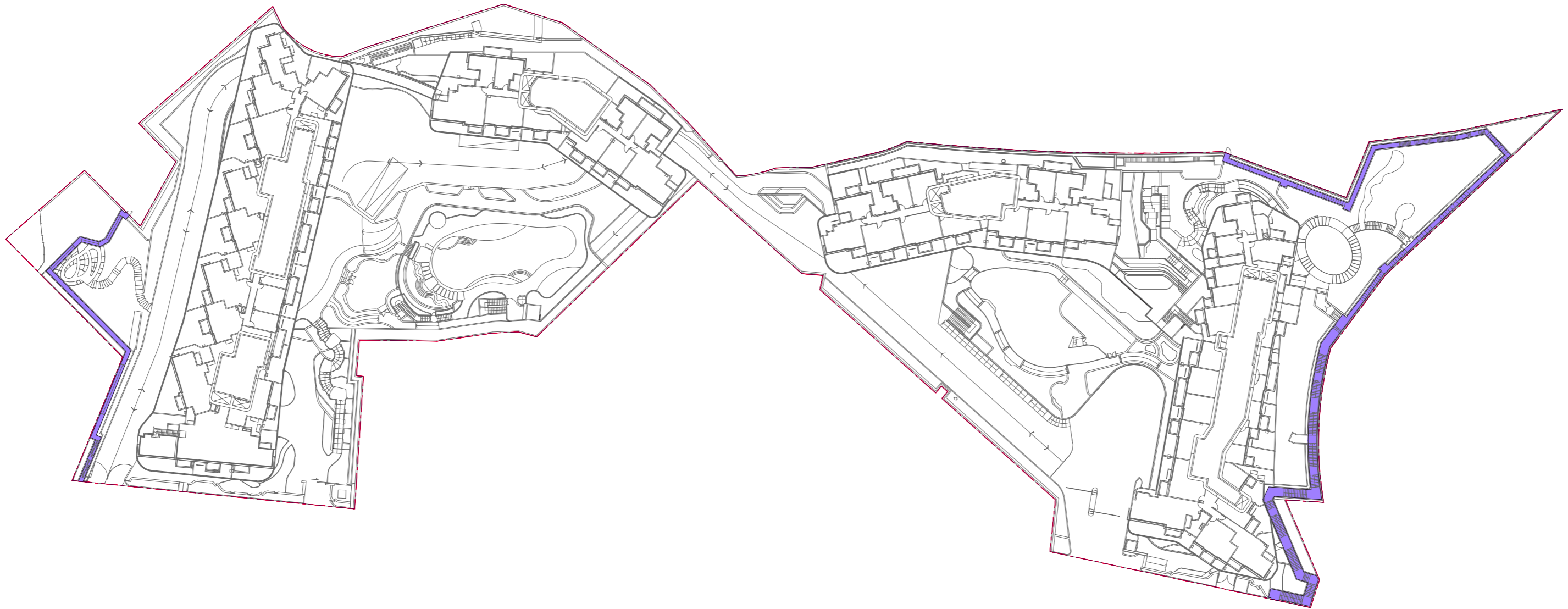



**LEGEND 圖例**

-  Boundary of the Development  
發展項目邊界
-  Proposed Pedestrian Walkway  
擬建之行人通道

Scale 0 25M/米  
比例 

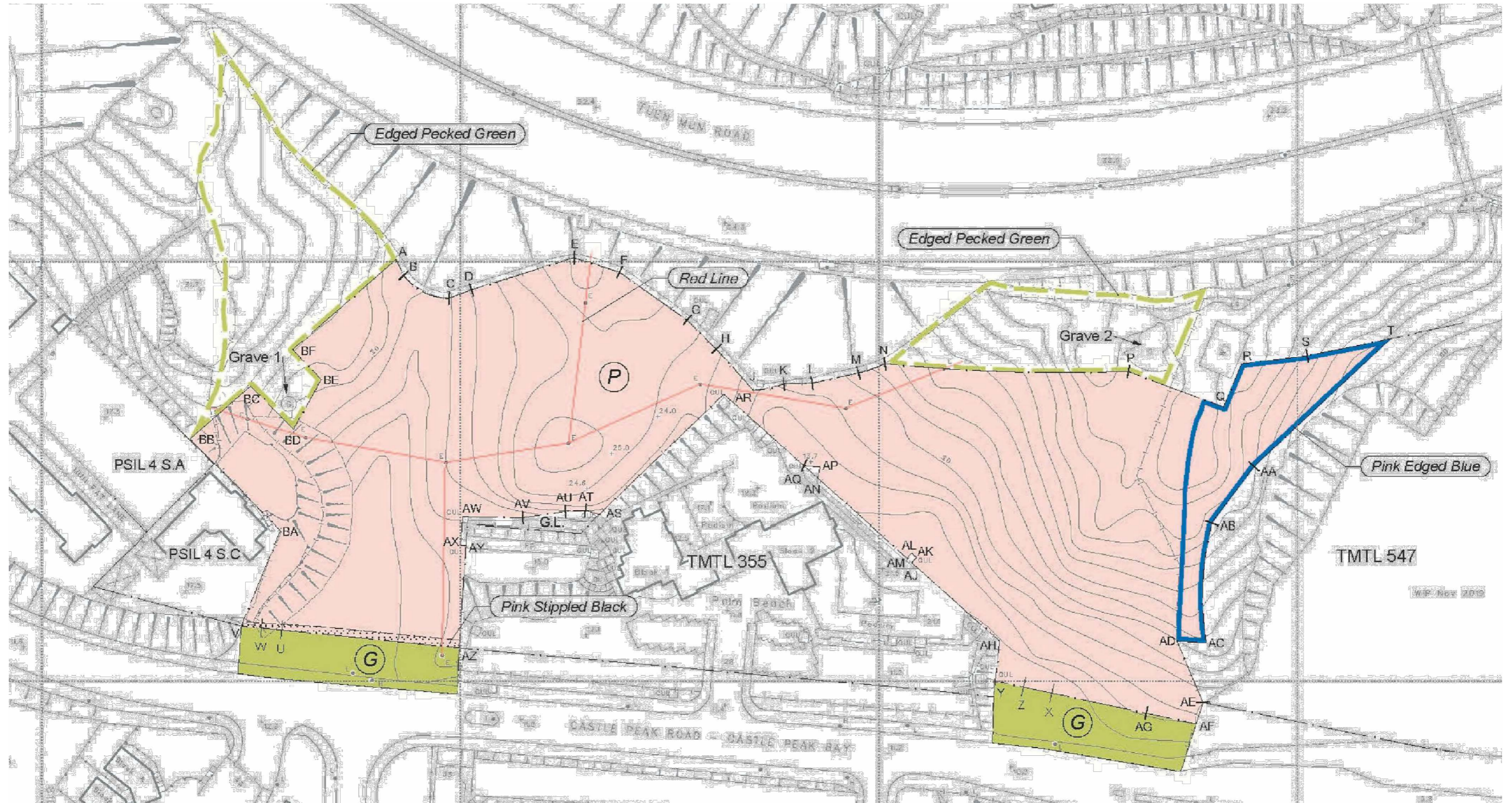

Legend 圖例



Green Areas 綠色範圍

Grave 1 / Grave 2 Existing Graves 現有墳墓

比例： 0米(M) 50米(M)  
Scale : 50米(M)

1. The purchaser is hereby recommended to instruct a separate firm of solicitors (other than that acting for the owner) to act for the purchaser in relation to the transaction.
  2. If the purchaser instructs such separate firm of solicitors to act for the purchaser in relation to the transaction, that firm will be able to give independent advice to the purchaser.
  3. If the purchaser instructs the firm of solicitors acting for the owner to act for the purchaser as well, and a conflict of interest arises between the owner and the purchaser:
    - (a) That firm may not be able to protect the purchaser's interests; and
    - (b) The purchaser may have to instruct a separate firm of solicitors.
  4. In case of paragraph 3(b), the total solicitors' fees payable by the purchaser may be higher than the fees that would have been payable if the purchaser had instructed a separate firm of solicitors in the first place.
1. 謹此建議買方聘用一間獨立的律師事務所（代表擁有人行事者除外），以在此交易中代表買方行事。
  2. 如買方聘用上述的獨立的律師事務所，以在交易中代表買方行事，該律師事務所將會能夠向買方提供獨立意見。
  3. 如買方聘用代表擁有人行事的律師事務所同時代表買方行事，而擁有人與買方之間出現利益衝突：
    - (a) 該律師事務所可能不能夠保障買方的利益；及
    - (b) 買方可能要聘用一間獨立的律師事務所。
  4. 如屬上述3(b)的情況，買方須支付的律師費用總數，可能高於如買方自一開始即聘用一間獨立的律師事務所便須支付的費用。

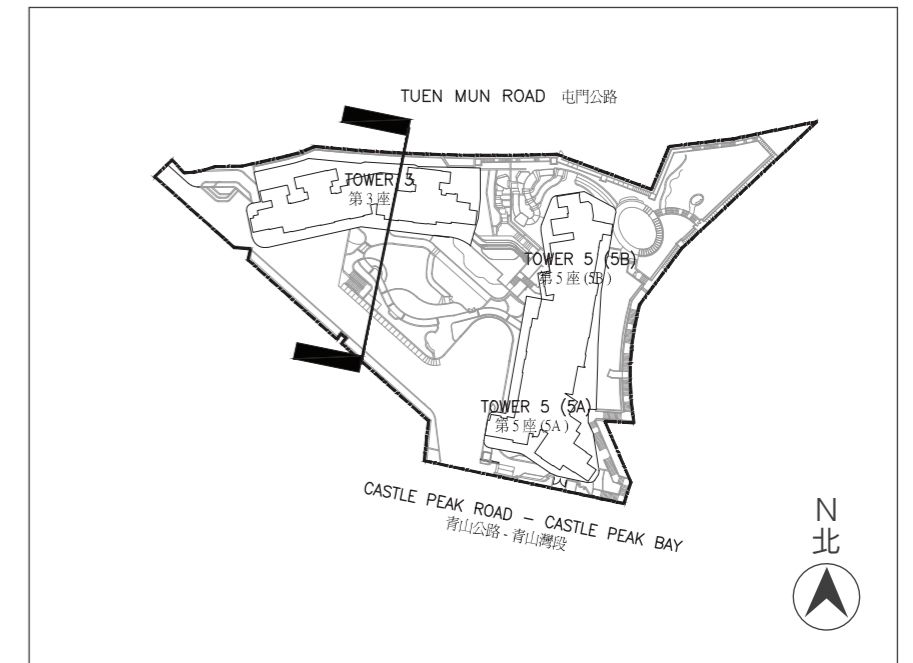
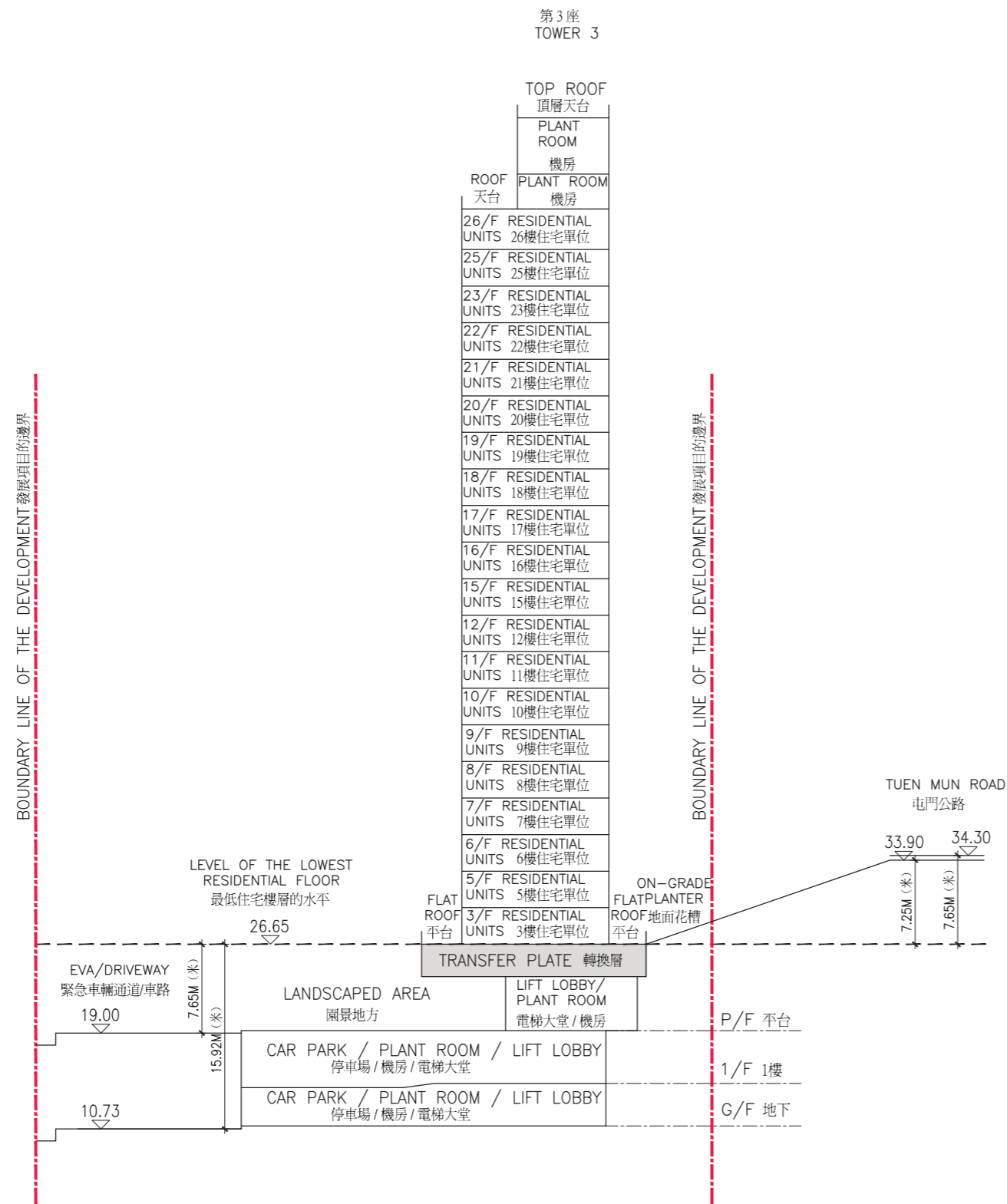

### LEGEND 圖例

Height in metres above the Hong Kong Principal Datum (HKPD) (in metres).  
香港主水平基準以上的高度 (米)。

Dotted line denotes the level of the lowest residential floor of the building.  
虛線為該建築物最低住宅樓層水平。

The part of Emergency Vehicular Access (EVA) / Driveway adjacent to the building is 10.73 metres to 19.00 metres above the Hong Kong Principal Datum.

毗連建築物的一段緊急車輛通道 / 車路為香港主水平基準以上 10.73 米至 19.00 米。

The part of Tuen Mun Road adjacent to the building is 33.90 metres to 34.30 metres above the Hong Kong Principal Datum.

毗連建築物的一段屯門公路為香港主水平基準以上 33.90 米至 34.30 米。

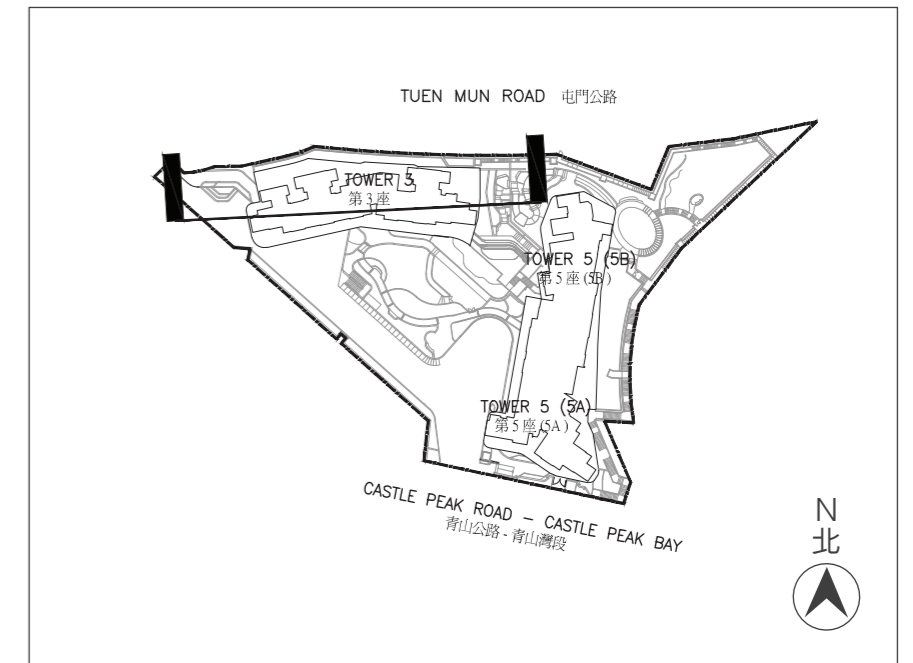
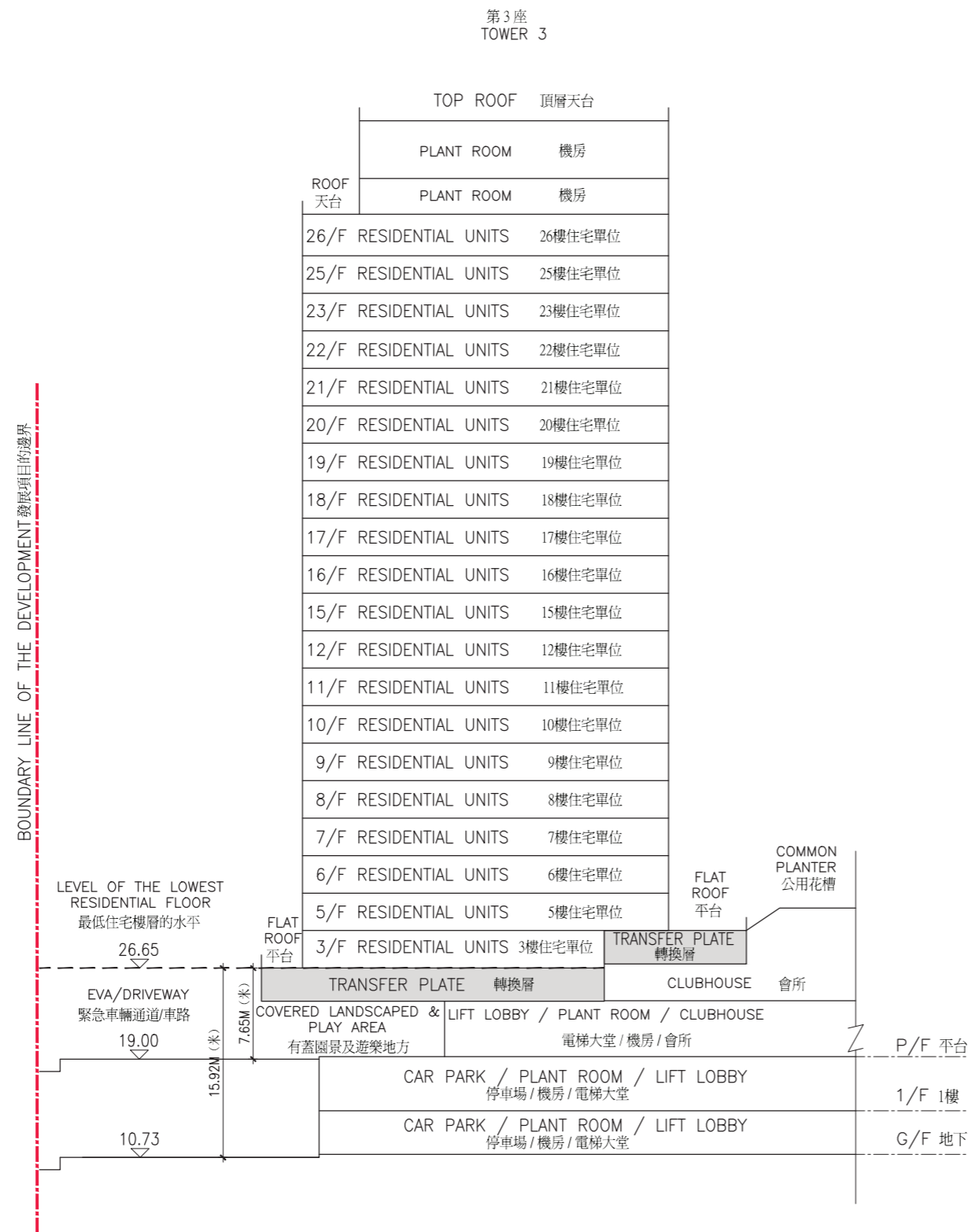

### LEGEND 圖例

Height in metres above the Hong Kong Principal Datum (HKPD) (in metres).  
香港主水平基準以上的高度(米)。

Dotted line denotes the level of the lowest residential floor of the building.  
虛線為該建築物最低住宅樓層水平。

The part of Emergency Vehicular Access (EVA) / Driveway adjacent to the building is 10.73 metres to 19.00 metres above the Hong Kong Principal Datum.  
毗連建築物的一段緊急車輛通道/車路為香港主水平基準以上10.73米至19.00米。

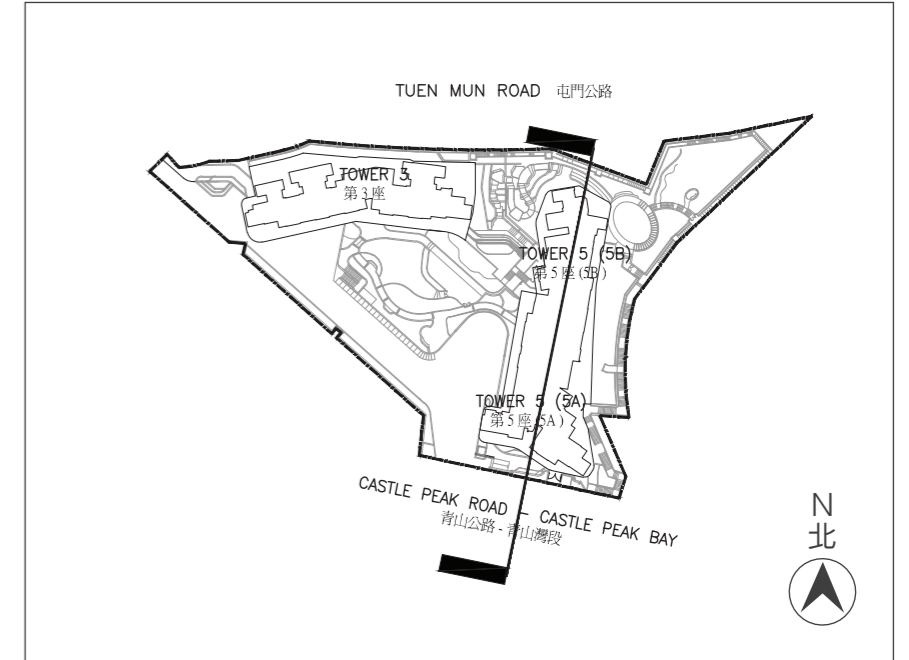
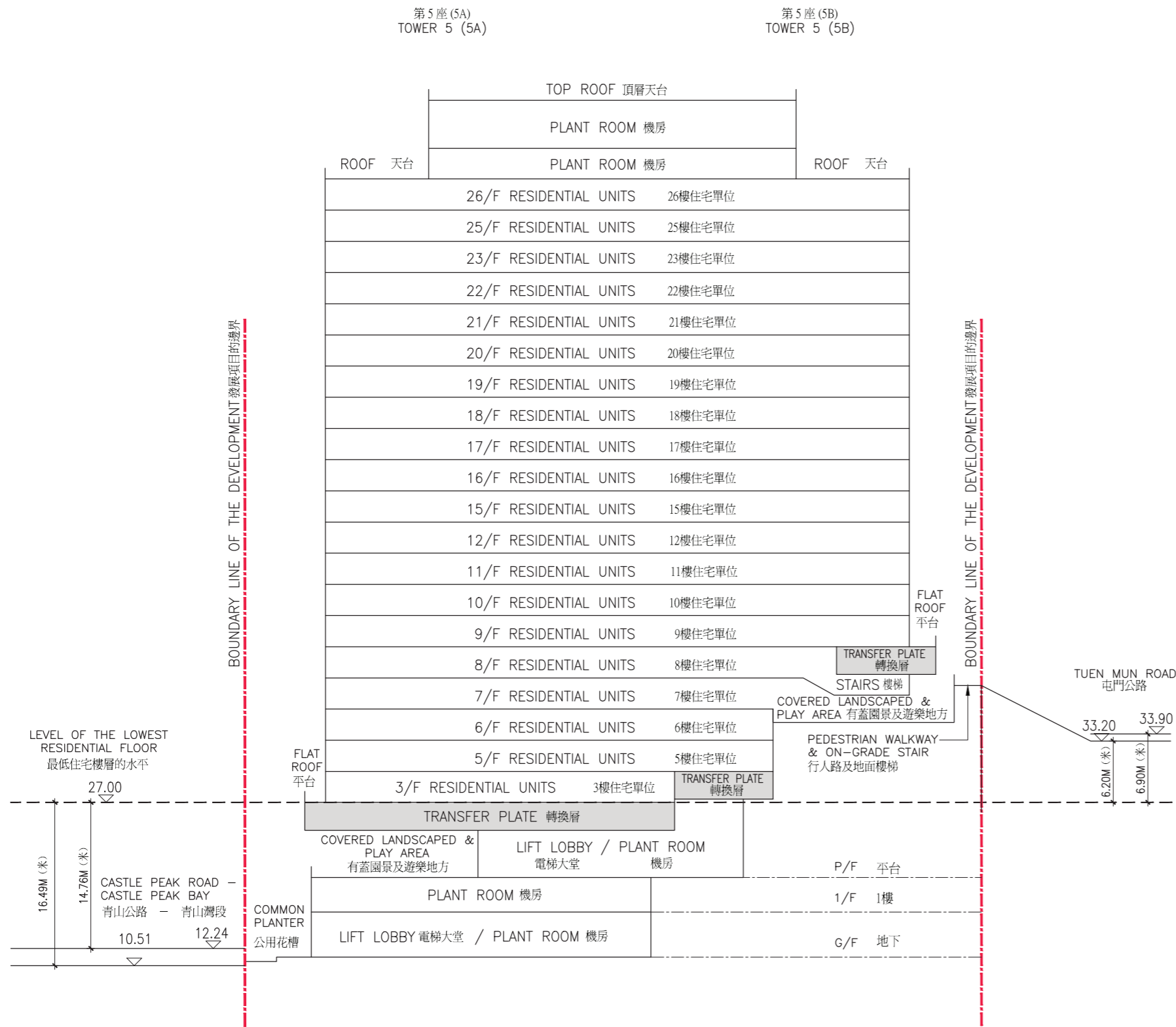

LEGEND 圖例

Height in metres above the Hong Kong Principal Datum (HKPD) (in metres).  
香港主水平基準以上的高度 (米)。

Dotted line denotes the level of the lowest residential floor of the building.  
虛線為該建築物最低住宅樓層水平。

The part of Castle Peak Road - Castle Peak Bay adjacent to the building is 10.51 metres to 12.24 metres above the Hong Kong Principal Datum.  
毗連建築物的一段青山公路 - 青山灣段為香港主水平基準以上 10.51 米至 12.24 米。

The part of Tuen Mun Road adjacent to the building is 33.20 metres to 33.90 metres above the Hong Kong Principal Datum.  
毗連建築物的一段屯門公路為香港主水平基準以上 33.20 米至 33.90 米。

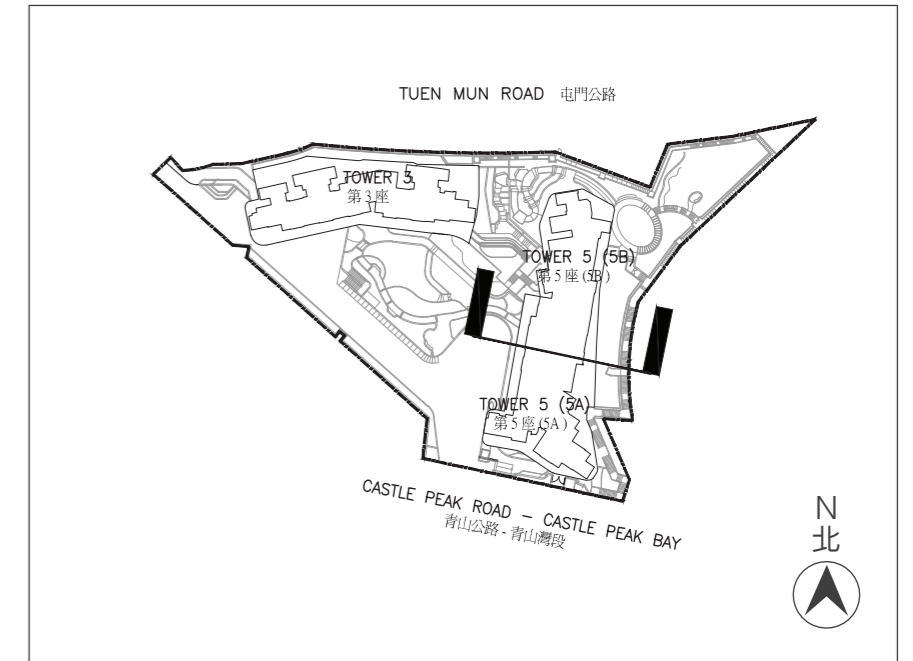
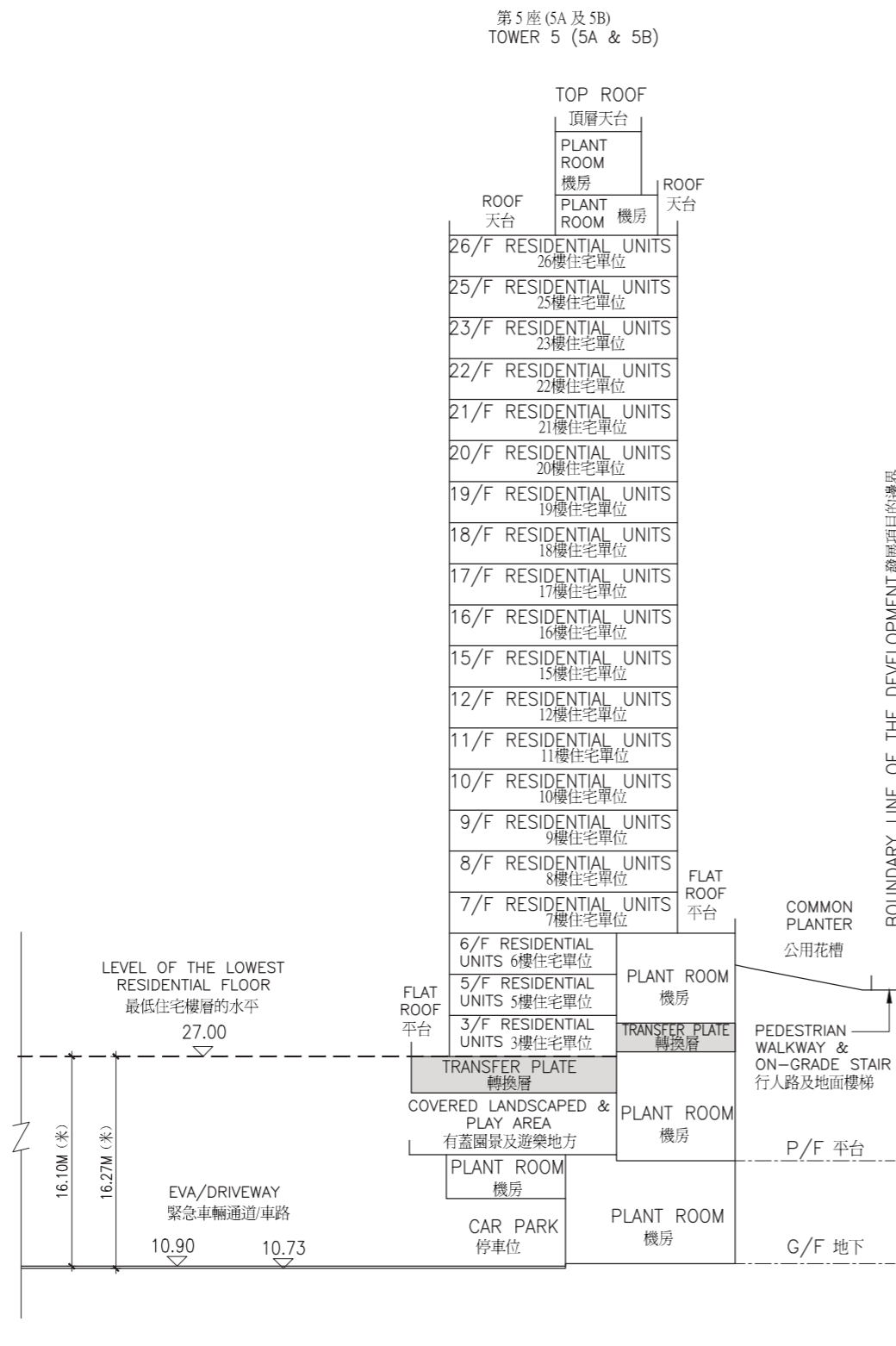

### LEGEND 圖例

 Height in metres above the Hong Kong Principal Datum (HKPD) (in metres).  
香港主水平基準以上的高度(米)。

 Dotted line denotes the level of the lowest residential floor of the building.  
虛線為該建築物最低住宅樓層水平。

The part of Emergency Vehicular Access (EVA) / Driveway adjacent to the building is 10.73 metres to 10.90 metres above the Hong Kong Principal Datum.  
毗連建築物的一段緊急車輛通道 / 車路為香港主水平基準以上 10.73 米至 10.90 米。

PODIUM ELEVATION  
基座立面圖

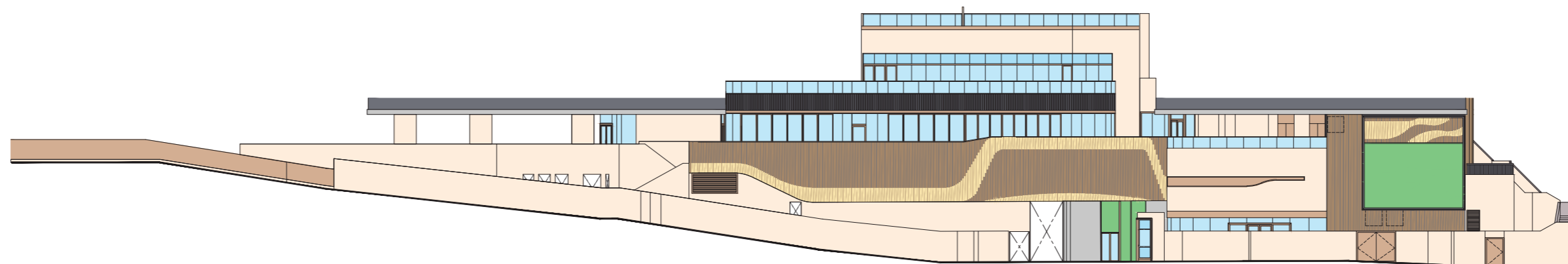
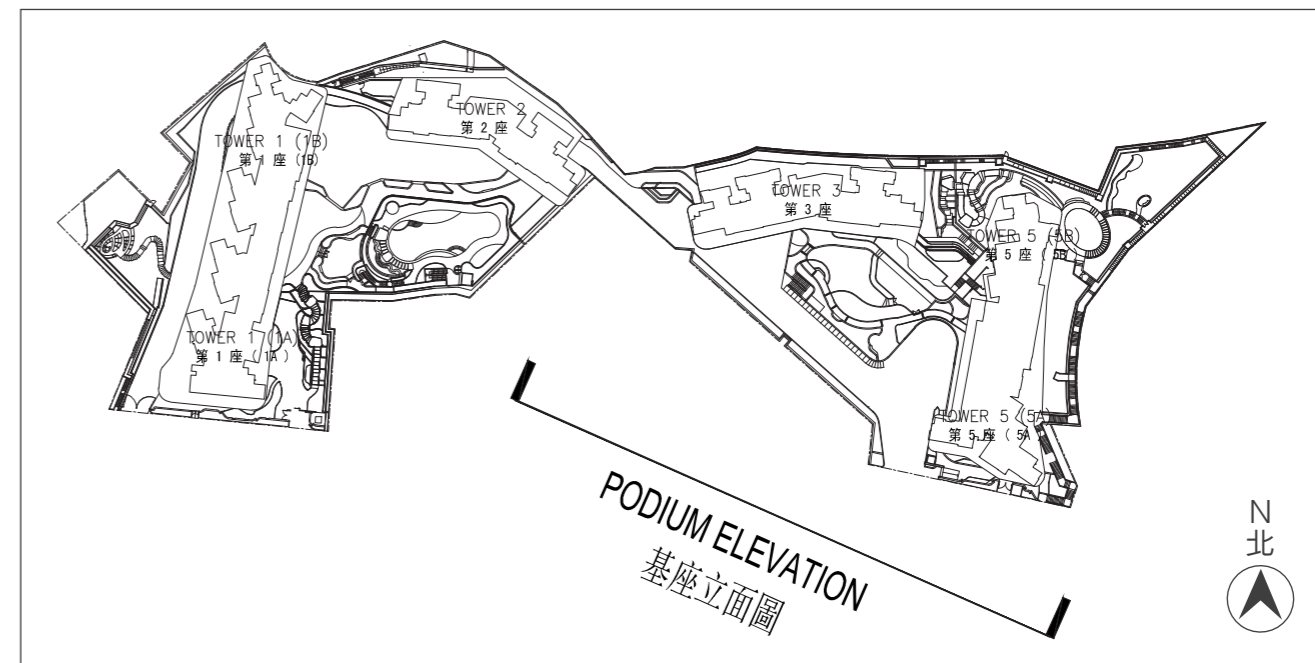

The Authorized Person for the Phase has certified that the elevations shown on these plans:  
1. are prepared on the basis of the approved building plans for the Phase as of 18 July 2024; and  
2. are in general accordance with the outward appearance of the Phase.

期數的認可人士已證明本圖所顯示的立面：  
1. 以2024年7月18日的情況為準的期數經批准的建築圖則為基礎擬備；及  
2. 大致上與該期數的外觀一致。



ELEVATION A (TOWER 3)  
立面圖 A (第3座)

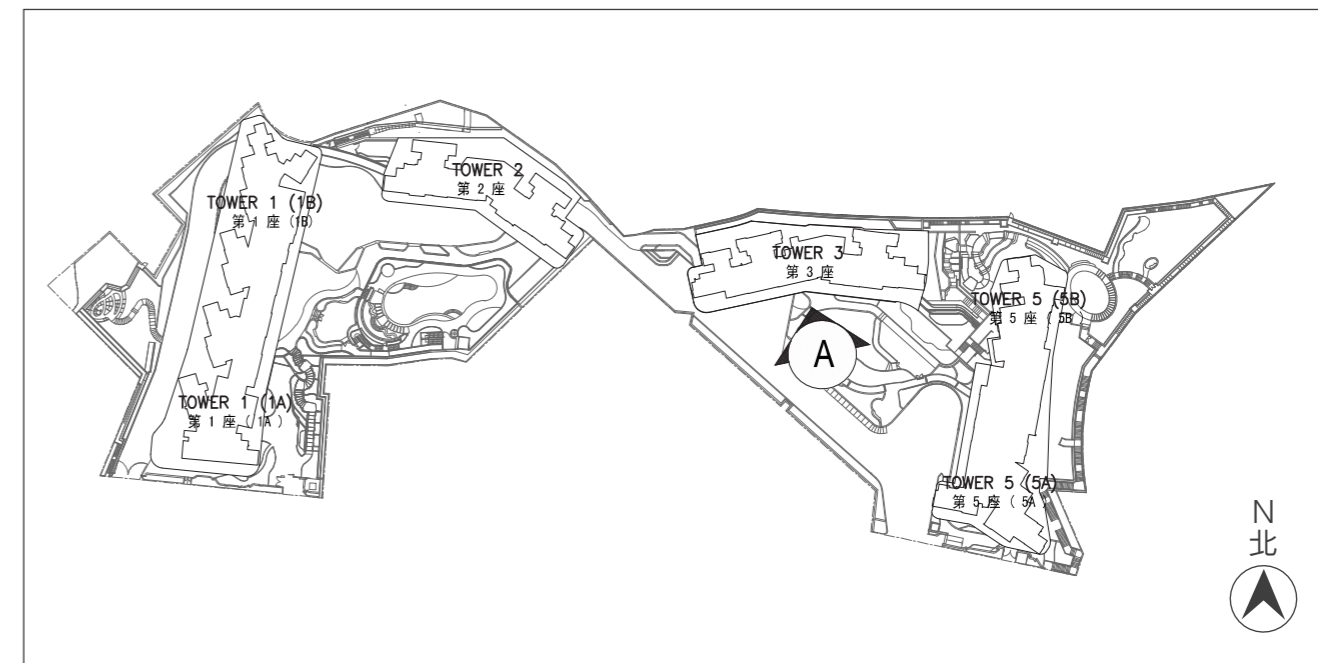
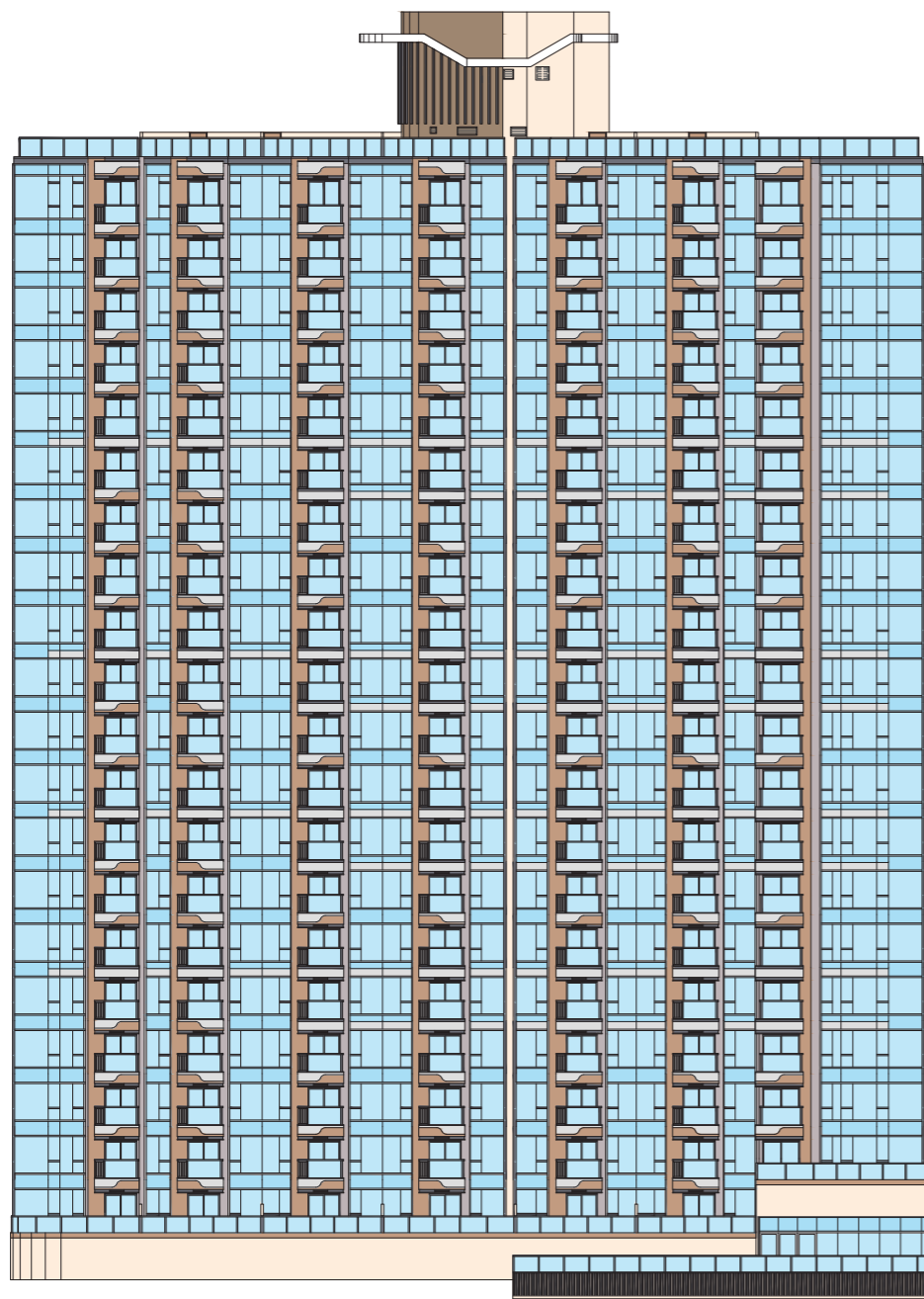

The Authorized Person for the Phase has certified that the elevations shown on these plans:  
 1. are prepared on the basis of the approved building plans for the Phase as of 18 July 2024; and  
 2. are in general accordance with the outward appearance of the Phase.

Note: 4/F, 13/F, 14/F and 24/F are omitted.

期數的認可人士已證明本圖所顯示的立面：  
 1. 以2024年7月18日的情況為準的期數批准的建築圖則為基礎擬備；及  
 2. 大致上與期數的外觀一致。

備註：不設4樓、13樓、14樓及24樓。

ELEVATION B (TOWER 3)  
立面圖 B (第3座)

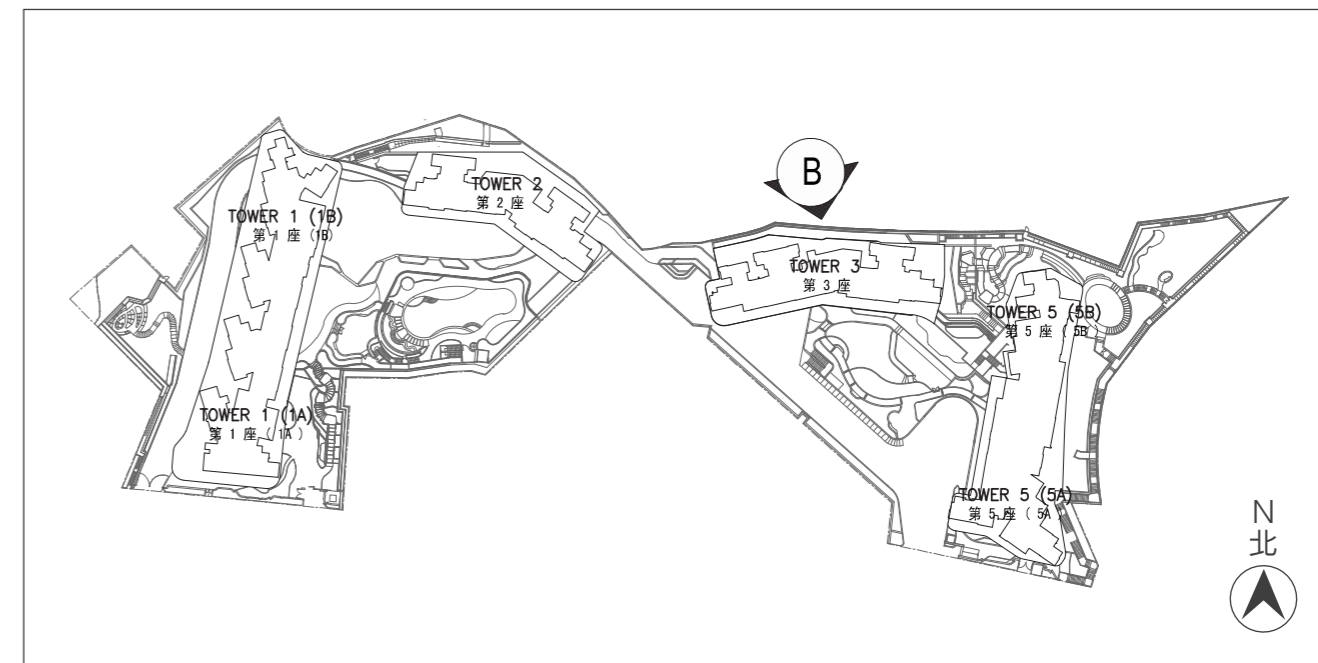
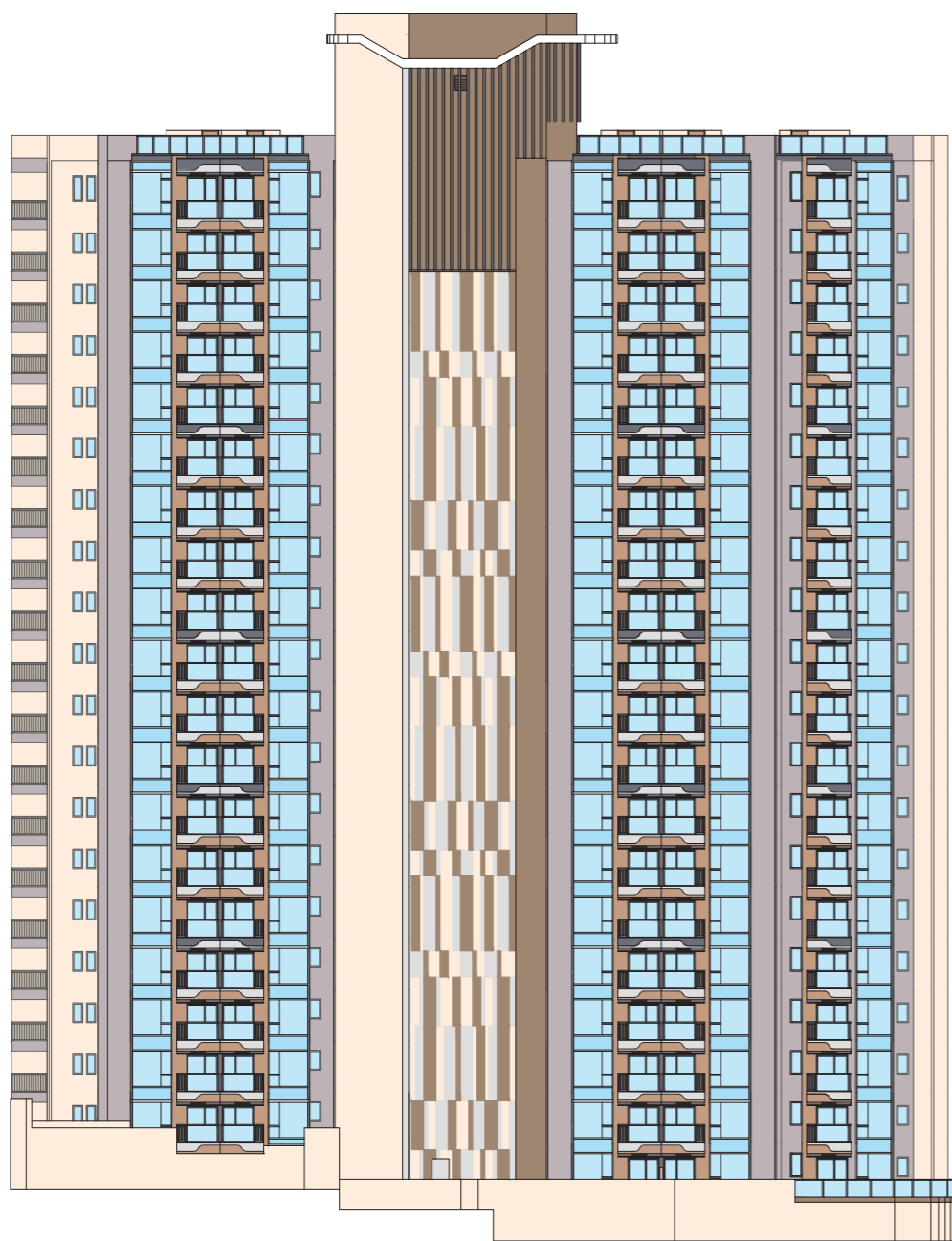

The Authorized Person for the Phase has certified that the elevations shown on these plans:  
1. are prepared on the basis of the approved building plans for the Phase as of 18 July 2024; and  
2. are in general accordance with the outward appearance of the Phase.

Note: 4/F, 13/F, 14/F and 24/F are omitted.

期數的認可人士已證明本圖所顯示的立面：  
1. 以2024年7月18日的情況為準的期數批准的建築圖則為基礎擬備；及  
2. 大致上與期數的外觀一致。

備註：不設4樓、13樓、14樓及24樓。

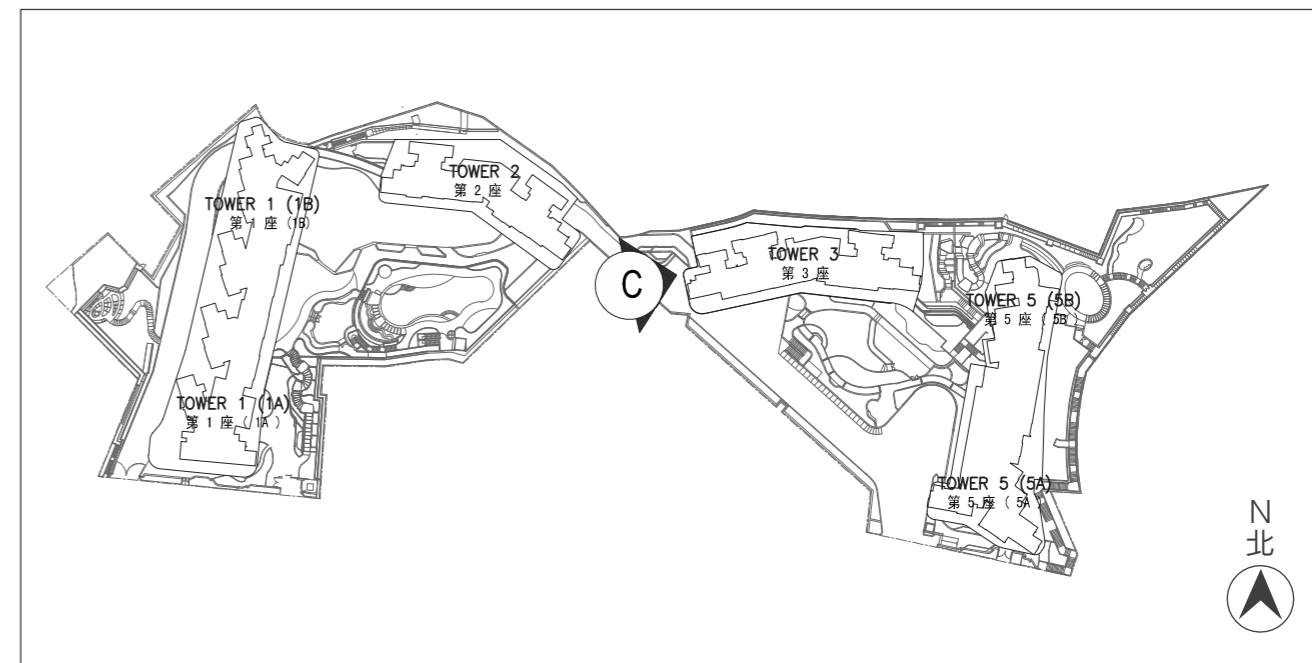
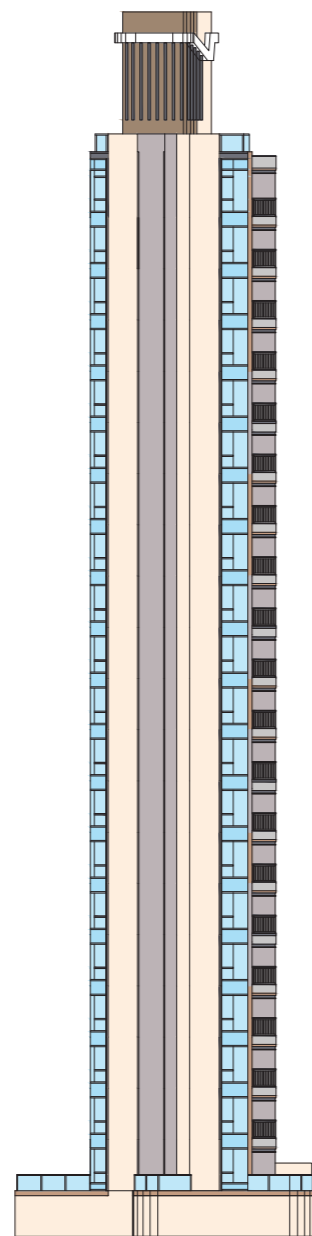
ELEVATION C (TOWER 3)  
立面圖 C (第3座)

The Authorized Person for the Phase has certified that the elevations shown on these plans:

1. are prepared on the basis of the approved building plans for the Phase as of 18 July 2024; and
2. are in general accordance with the outward appearance of the Phase.

Note: 4/F, 13/F, 14/F and 24/F are omitted.

期數的認可人士已證明本圖所顯示的立面：

1. 以2024年7月18日的情況為準的期數批准的建築圖則為基礎擬備；及
2. 大致上與期數的外觀一致。

備註：不設4樓、13樓、14樓及24樓。

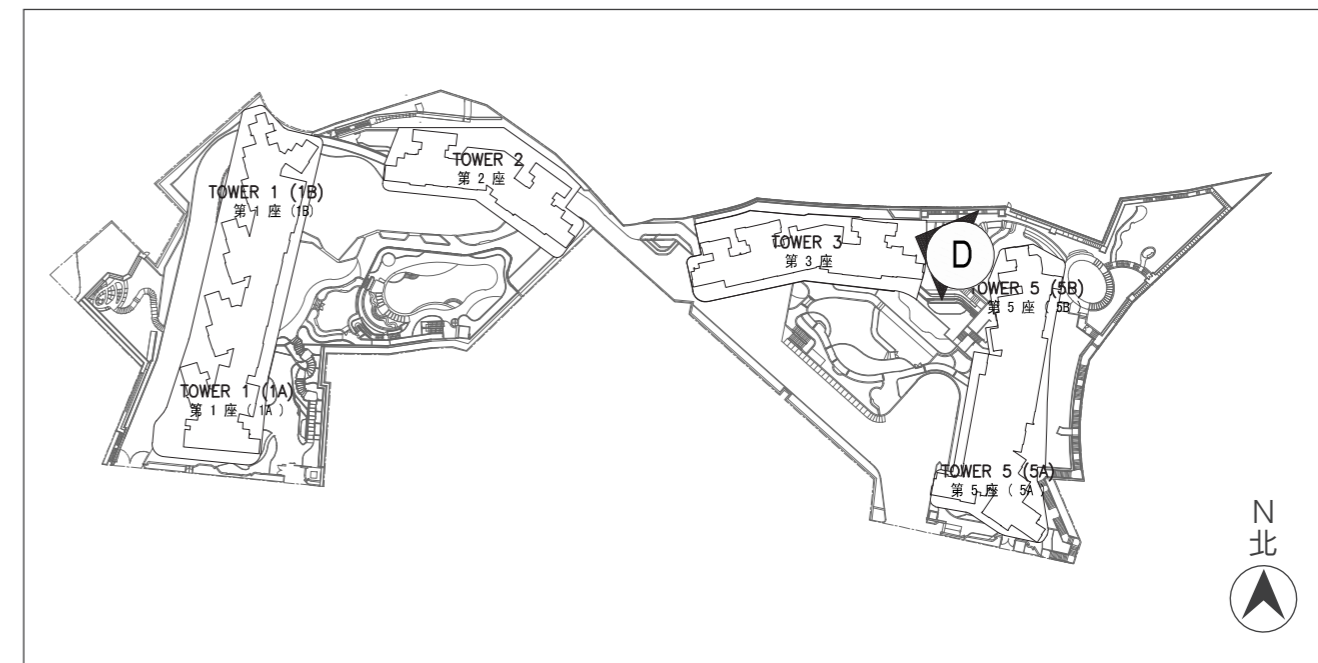
ELEVATION D (TOWER 3)  
立面圖 D (第3座)

The Authorized Person for the Phase has certified that the elevations shown on these plans:

1. are prepared on the basis of the approved building plans for the Phase as of 18 July 2024; and
2. are in general accordance with the outward appearance of the Phase.

Note: 4/F, 13/F, 14/F and 24/F are omitted.

期數的認可人士已證明本圖所顯示的立面：

1. 以2024年7月18日的情況為準的期數批准的建築圖則為基礎擬備；及
2. 大致上與期數的外觀一致。

備註：不設4樓、13樓、14樓及24樓。

ELEVATION A (TOWER 5 (5A & 5B))  
立面圖 A (第5座 (5A 及 5B))

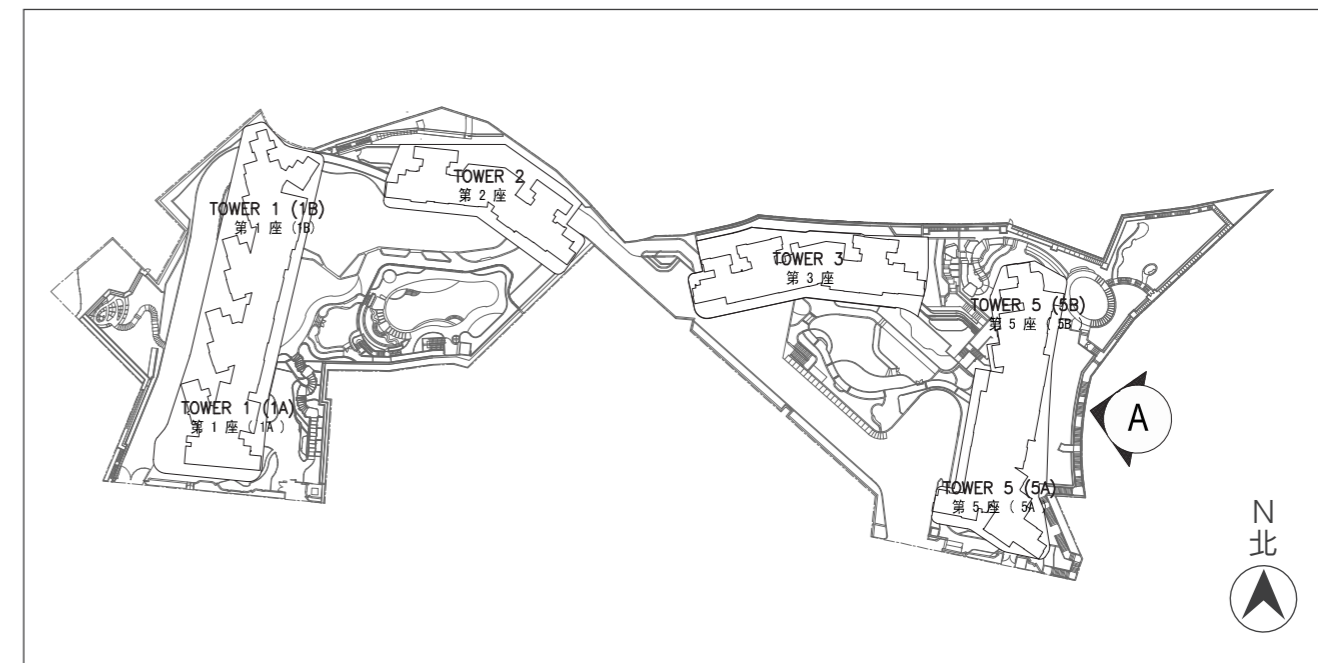

The Authorized Person for the Phase has certified that the elevations shown on these plans:  
1. are prepared on the basis of the approved building plans for the Phase as of 18 July 2024; and  
2. are in general accordance with the outward appearance of the Phase.

Note: 4/F, 13/F, 14/F and 24/F are omitted.

期數的認可人士已證明本圖所顯示的立面：

1. 以2024年7月18日的情況為準的期數批准的建築圖則為基礎擬備；及
2. 大致上與期數的外觀一致。

備註：不設4樓、13樓、14樓及24樓。

ELEVATION B (TOWER 5 (5A & 5B))  
立面圖 B (第5座 (5A 及 5B))

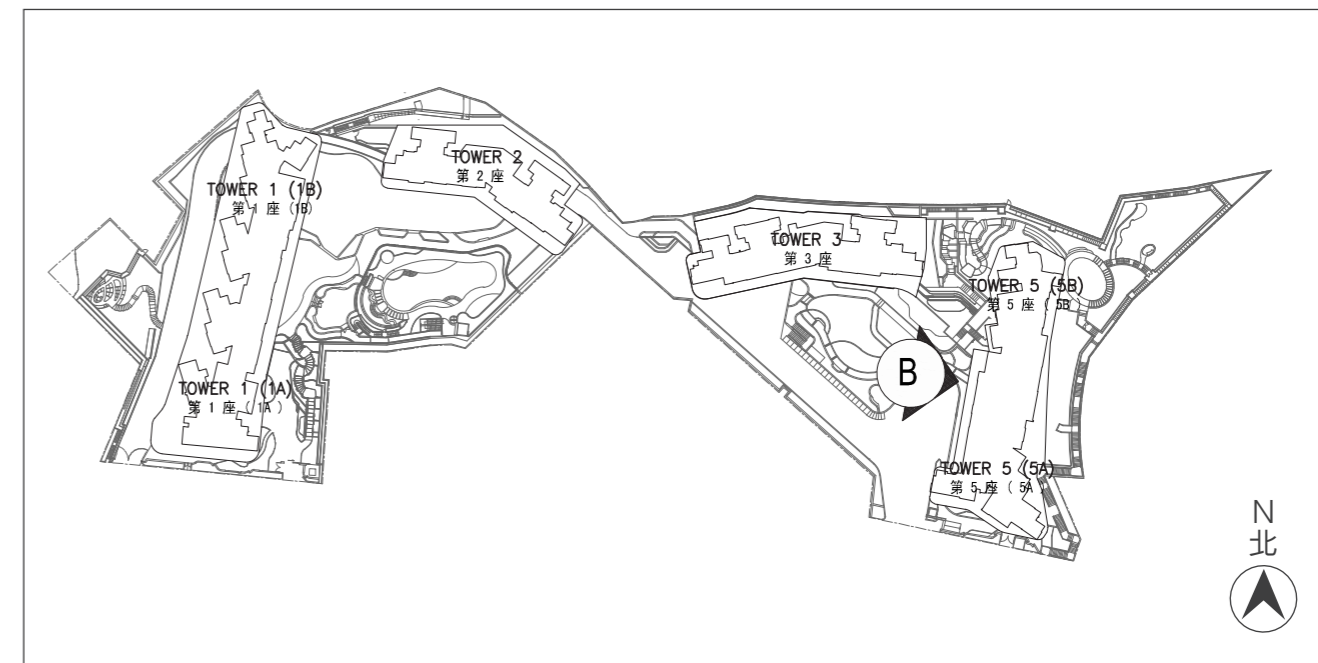

The Authorized Person for the Phase has certified that the elevations shown on these plans:  
1. are prepared on the basis of the approved building plans for the Phase as of 18 July 2024; and  
2. are in general accordance with the outward appearance of the Phase.

Note: 4/F, 13/F, 14/F and 24/F are omitted.

期數的認可人士已證明本圖所顯示的立面：  
1. 以2024年7月18日的情況為準的期數批准的建築圖則為基礎擬備；及  
2. 大致上與期數的外觀一致。

備註：不設4樓、13樓、14樓及24樓。

ELEVATION C (TOWER 5 (5A & 5B))  
立面圖 C (第5座 (5A 及 5B))

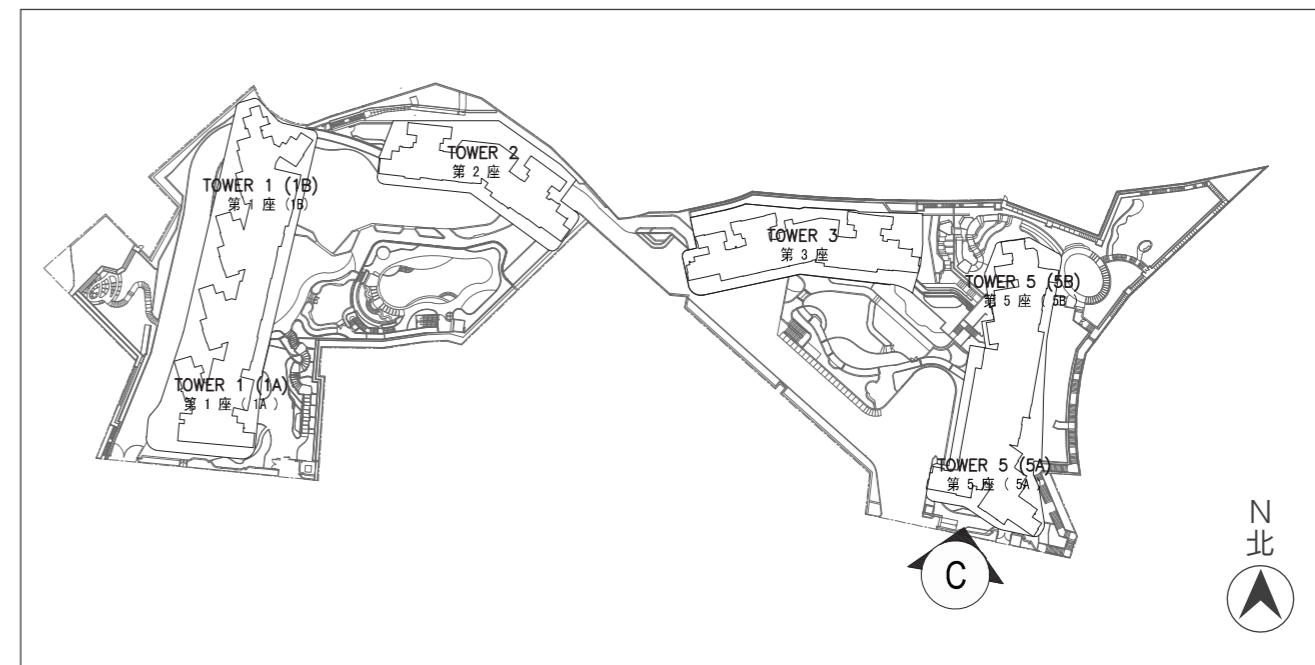
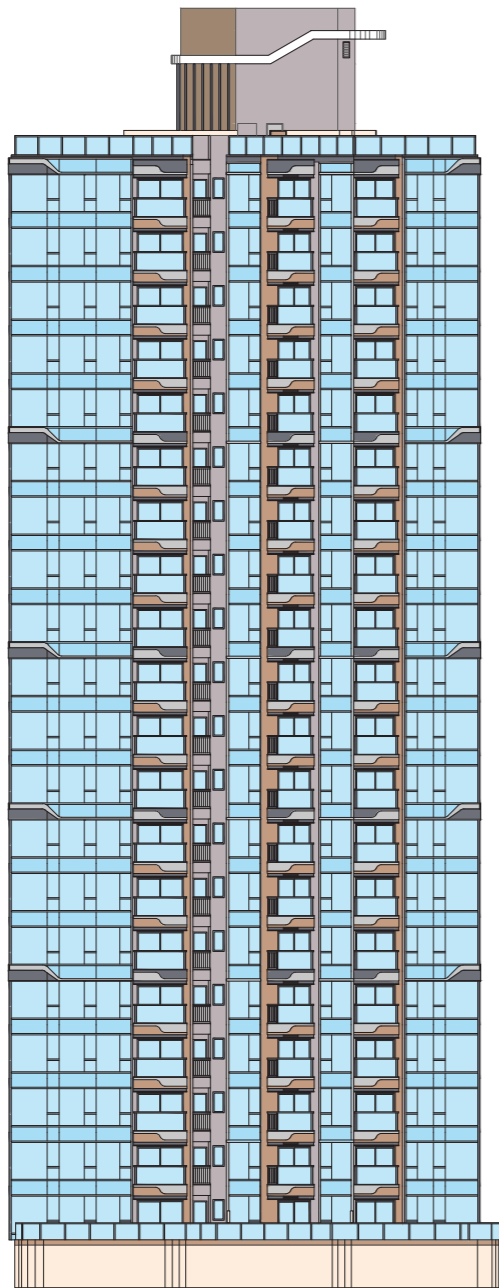

The Authorized Person for the Phase has certified that the elevations shown on these plans:  
1. are prepared on the basis of the approved building plans for the Phase as of 18 July 2024; and  
2. are in general accordance with the outward appearance of the Phase.

Note: 4/F, 13/F, 14/F and 24/F are omitted.

期數的認可人士已證明本圖所顯示的立面：  
1. 以2024年7月18日的情況為準的期數批准的建築圖則為基礎擬備；及  
2. 大致上與期數的外觀一致。

備註：不設4樓、13樓、14樓及24樓。

ELEVATION D (TOWER 5 (5A & 5B))  
立面圖 D (第5座 (5A 及 5B))

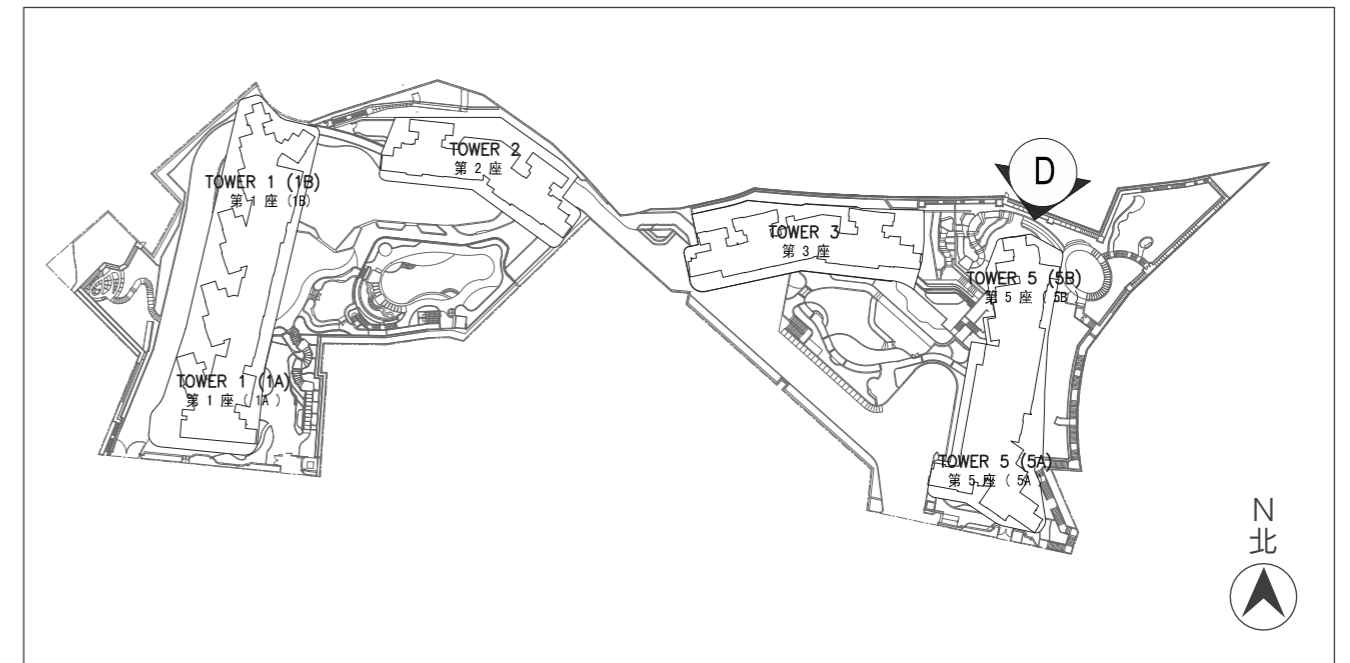
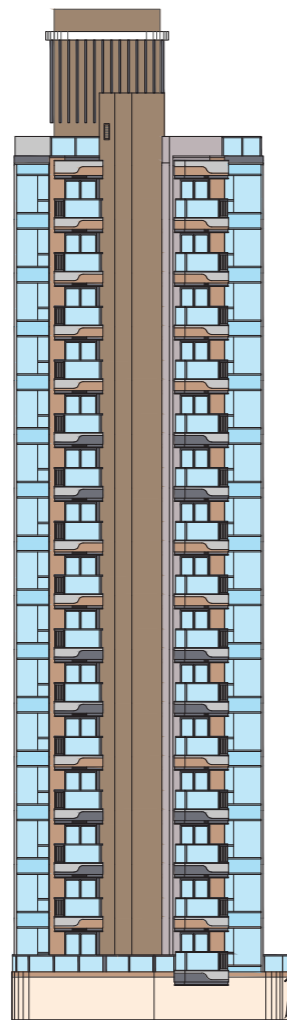

The Authorized Person for the Phase has certified that the elevations shown on these plans:  
1. are prepared on the basis of the approved building plans for the Phase as of 18 July 2024; and  
2. are in general accordance with the outward appearance of the Phase.

Note: 4/F, 13/F, 14/F and 24/F are omitted.

期數的認可人士已證明本圖所顯示的立面：

1. 以2024年7月18日的情況為準的期數批准的建築圖則為基礎擬備；及
2. 大致上與期數的外觀一致。

備註：不設4樓、13樓、14樓及24樓。



Common facilities 公用設施		Area 面積		Total Area 總面積	
		Area (sq.m.) 面積(平方米)	Area (sq.ft.) 面積(平方呎)	Area (sq.m.) 面積(平方米)	Area (sq.ft.) 面積(平方呎)
Residents' clubhouse (including any recreational facilities for residents' use) 住客會所 (包括供住客使用的任何康樂設施)	Covered Area 有上蓋	1019.502	10974	1139.881	12270
	Uncovered Area 無上蓋	120.379	1296		
Communal garden or play area for residents' use on the roof, or on any floor between the roof and the lowest residential floor, of a building in the Phase (whether known as a communal sky garden or otherwise) 位於期數中的建築物的天台或在天台和最低一層住宅樓層之間的任何一層的、供住客使用的公用花園或遊樂地方 (不論是稱為公用空中花園或有其他名稱)	Covered Area 有上蓋	198.193	2133	211.988	2282
	Uncovered Area 無上蓋	13.795	148		
Communal garden or play area for residents' use below the lowest residential floor of a building in the Phase (whether known as a covered and landscaped play area or otherwise) 位於期數中的建築物的最低一層住宅樓層以下的、供住客使用的公用花園或遊樂地方 (不論是稱為有蓋及園景的遊樂場或有其他名稱)	Covered Area 有上蓋	633.325	6817	3269.131	35189
	Uncovered Area 無上蓋	2635.806	28372		

## Remarks :

Areas in square feet are converted from areas in square metres at a rate of 1 square metre to 10.764 square feet and rounded off to the nearest integer.

## 備註：

以平方呎顯示之面積由以平方米顯示之面積以 1 平方米 = 10.764 平方呎換算，並四捨五入至整數。

1. Copy(ies) of the Outline Zoning Plan(s) relating to the Development is available at: <http://www.ozp.tpb.gov.hk>
  - 2 (a) A copy of the latest draft of every deed of mutual covenant in respect of the specified residential property as at the date on which the specified residential property is offered to be sold is available for inspection at the place at which the specified residential property is offered to be sold.  
  
(b) The inspection is free of charge.
1. 備有關乎本發展項目的分區計劃大綱圖的文本供閱覽的互聯網網站的網址為：<http://www.ozp.tpb.gov.hk>。
  2. (a) 指明住宅物業的每一公契在將指明住宅物業提供出售的日期的最新擬稿的文本存放在指明住宅物業的售樓處，以供閱覽。  
  
(b) 無須為閱覽付費。

## 1. Exterior finishes

Item		Description		
(a)	External walls	Type of finishes	Façade of residential towers finished with tiles, curtain walls, glass claddings, metal claddings, paint, louvres and grilles	
			Transfer plate finished with paint	
			Podium finished with window walls, glass claddings, vertical greenery, tiles, stone claddings, metal claddings, louvres, grilles and paint	
(b)	Window	Material of frame	Fluorocarbon coated aluminum frame	
		Material of glass	Curtain walls: insulating glass unit (IGU) Living Rooms, Dining Rooms and Open Kitchens (if window is provided except curtain walls): tinted tempered glass Kitchens and Store Rooms (if window is provided): clear tempered glass Bathrooms (if window is provided): obscure tempered glass	
(c)	Bay window	Material of bay window	Not applicable	
		Finishes of window sill	Not applicable	
(d)	Planter	Type of finishes	Stone and tiles	
(e)	Verandah or Balcony	(i) Type of finishes	Balcony	Glass balustrade with aluminium post, metal top rail and tiles
			Balcony floor	Tiles
			Balcony walls	Tiles and aluminum claddings
			Balcony ceiling	Aluminum ceiling
			Verandah	No verandah
		(ii) Whether it is covered	Balcony	Balcony is covered
	Verandah	No verandah		
(f)	Drying facilities for clothing	Type	Not applicable	
		Material	Not applicable	

Note: 4/F, 13/F, 14/F and 24/F are omitted.

## 1. 外部裝修物料

細項		描述		
(a)	外牆	裝修物料的類型	住宅大樓外牆為瓷磚、幕牆、玻璃蓋板、金屬蓋板、油漆、百葉及格柵 轉換層為油漆 基座為玻璃窗牆、玻璃蓋板、垂直綠化、瓷磚、石蓋板、金屬蓋板、百葉、格柵及油漆	
		框的用料	氟化碳塗鋁框	
(b)	窗	玻璃的用料	幕牆：雙層中空玻璃 客廳、飯廳及開放式廚房（除幕牆外如設有窗）：有色強化玻璃 廚房及儲物房（如設有窗）：清鋼化玻璃 浴室（如設有窗）：磨砂鋼化玻璃	
		窗台的用料	不適用	
(c)	窗台	窗台板的裝修物料	不適用	
		窗台的用料	不適用	
(d)	花槽	裝修物料的類型	石材及瓷磚	
(e)	陽台或露台	(i) 裝修物料的類型	露台	玻璃欄杆配以鋁質企柱、金屬頂欄及瓷磚
			露台地板	瓷磚
			露台牆壁	瓷磚及鋁質蓋板
			露台天花板	鋁質天花
		(ii) 是否有蓋	露台	露台有蓋
			陽台	沒有陽台
(f)	乾衣設施	類型	不適用	
		用料	不適用	

備註：不設4樓、13樓、14樓及24樓。

## 2. Interior finishes

Item		Description			
		Location	Wall	Floor	Ceiling
(a)	Lobby	Type of finishes of Residential Lift Lobby at Residential floors	Tiles, timber veneer finish, plastic laminate, metal and fitted with wall lamp	Tiles	Gypsum board false ceiling with emulsion paint on exposed surfaces, metal trim and fitted with light troughs and downlights
		Type of finishes of Residential Lift Lobby at P/F	Natural stone, glass, plastic laminate, metal and fitted with wall lamp	Natural stone	Gypsum board false ceiling with emulsion paint on exposed surfaces, metal trim and fitted with light troughs and downlights
		Type of finishes of Residential Lift Lobby at Carpark floors	Natural stone, wood veneer finish, metal and fitted with wall lamp	Natural stone	Gypsum board false ceiling with emulsion paint on exposed surfaces, fitted with light troughs and downlights
		Type of finishes of Shuttle Lift Lobby at G/F	Natural stone, wood veneer finish, metal and fitted with wall lamp	Natural stone	Gypsum board false ceiling with emulsion paint on exposed surfaces, fitted with light troughs and downlights
		Location	Wall	Ceiling	
(b)	Internal Wall and Ceiling	Living Room, Dining Room, Master Bedroom and Bedroom	Emulsion paint to exposed surfaces For Units with Open Kitchen: Partial wall finished with Medium-density fiberboard with high gloss lacquer paint finish and metal skirting	Emulsion paint to exposed surfaces. Partial areas with gypsum board false ceiling, bulkhead finished with emulsion paint	
		Location	Floor		Skirting
(c)	Internal Floor	Living Room, Dining Room, Master Bedroom and Bedroom	For Units with Open Kitchen: Floor finished with tiles For Units with Kitchen: Floor finished with engineering timber flooring. Natural stone border and metal trim along edge of flooring adjoining to Balconies, Utility Platforms, Flat Roofs and Gardens (if applicable)		Timber skirting
		Wall	Floor	Ceiling	
(d)	Bathroom	(i) Type of finishes	Tiles on exposed surfaces	Tiles	Gypsum board false ceiling finished with emulsion paint, aluminum panel, metal trim fitted with downlights
		(ii) Whether the wall finishes run up to the ceiling	Run up to level of false ceiling		

Note: 4/F, 13/F, 14/F and 24/F are omitted.

## 2. 室內裝修物料

細項		描述			
		位置	牆壁	地板	天花板
(a)	大堂	住宅樓層之住宅電梯大堂的裝修物料的類型	瓷磚、木皮飾面、膠板、金屬並裝設壁燈	瓷磚	外露位置為石膏板假天花髹上乳膠漆、金屬飾條、並裝設燈槽及筒燈
		平台層之住宅電梯大堂的裝修物料的類型	天然石材、玻璃、膠板、金屬並裝設壁燈	天然石材	外露位置為石膏板假天花髹上乳膠漆、金屬飾條、並裝設燈槽及筒燈
		停車場樓層之住宅電梯大堂的裝修物料的類型	天然石材、木皮飾面、金屬並裝設壁燈	天然石材	外露位置為石膏板假天花髹上乳膠漆、並裝設燈槽及筒燈
		地下之穿梭電梯大堂的裝修物料的類型	天然石材、木皮飾面、金屬並裝設壁燈	天然石材	外露位置為石膏板假天花髹上乳膠漆、並裝設燈槽及筒燈
		位置	牆壁	天花板	
(b)	內牆及天花板	客廳、飯廳、主人睡房及睡房	外露位置髹上乳膠漆 具有開放式廚房的單位： 中級密度纖維板配高光度油漆飾面及金屬腳線	外露位置髹上乳膠漆。部分的天花位置裝設石膏板假天花、假陣及髹上乳膠漆	
		位置	地板		牆腳線
(c)	內部地板	客廳、飯廳、主人睡房及睡房	具有開放式廚房的單位： 地台為瓷磚 具有廚房的單位： 地台為複合木地板。沿通往露台、工作平台、平台及花園(如適用)之地台圍邊部分為天然石材及金屬飾條		木牆腳線
		牆壁	地板	天花板	
(d)	浴室	(i) 裝修物料的類型	外露位置鋪砌瓷磚	瓷磚	石膏板假天花髹上乳膠漆、鋁板、金屬飾條並裝設筒燈
		(ii) 牆壁的裝修物料是否鋪至天花板	鋪至假天花高度		

備註：不設4樓、13樓、14樓及24樓。

## 2. Interior finishes

Item		Description				
		Wall	Floor	Ceiling	Cooking Bench	
(e)	Kitchen	(i) Type of finishes	Tiles on exposed surfaces	For Units with Open Kitchen: Tiles	For Units with Open Kitchen: Emulsion paint to exposed surfaces. Partial areas with gypsum board bulkhead finished with emulsion paint	Artificial stone
				For Units with Kitchen: Tiles with metal trim along edge of flooring at kitchen door	For Units with Kitchen: Gypsum board false ceiling finished with emulsion paint, aluminum panel, metal trim fitted with downlights	
		(ii) Whether the wall finishes run up to the ceiling	Run up to level of false ceiling			

Note: 4/F, 13/F, 14/F and 24/F are omitted.

## 2. 室內裝修物料

細項		描述				
		牆壁	地板	天花板	灶台	
(e)	廚房	(i) 裝修物料的類型	外露位置鋪砌瓷磚	具有開放式廚房的單位： 瓷磚	具有開放式廚房的單位： 外露位置髹上乳膠漆。部分的天花位置裝設石膏板假陣及髹上乳膠漆	人造石
		(ii) 牆壁的裝修物料是否鋪至天花板	鋪至假天花高度	具有廚房的單位： 瓷磚及沿廚房門邊之地台部分為金屬飾條	具有廚房的單位： 石膏板假天花髹上乳膠漆、鋁板、金屬飾條並裝設筒燈	

備註：不設4樓、13樓、14樓及24樓。



## 3. Interior fittings

Item		Description					
		Materials		Finish	Accessories		
(a)	Door	Main Entrance Door	Solid core fire rated timber swing door and timber door frame		Timber veneer finish	Electronic lockset with handle, door hinge, door closer, door stopper, eye viewer, bottom seal and smoke seal	
		Master Bedroom, Bedroom and Store Room 2 Door	Hollow core timber swing door and timber door frame		Timber veneer finish	Lockset with handle, door hinge and door stopper	
		Master Bathroom and Bathroom Door	(i)	Hollow core timber swing door and timber door frame with timber louver (except for the units specified below):		Timber veneer finish	Lockset with handle, door hinge and door stopper
				(ii)	Hollow core timber swing door and timber door frame (for the following units):		
			Tower 3		Master Bathroom		
				Bathroom	Units A, G & H		
		Tower 5 (5A)	Master Bathroom	Units C			
			Bathroom	Units A			
		Kitchen Door	Solid core fire rated timber swing door and timber door frame		Timber veneer finish	Lockset with handle, door hinge, door closer, door stopper, fire rated glass vision panel, bottom seal and smoke seal	
		Walk-in Closet Door	Hollow core timber sliding door and timber door frame		Timber veneer finish	Lockset with handle and sliding track	
Balcony Door, Balcony and Utility Platform Door, Flat Roof Door, Flat Roof and Garden Door	(i)	Aluminium framed glass sliding door (for the following units):		Aluminium and tempered glass	Lockset with handle and sliding track		
		Tower 3	Units A, B, C, D, E, F & G				
		Tower 5 (5A)	Units A, B, C, D, E, F, G, H, J, P, Q & R				
	Tower 5 (5B)	Units A, B, M & N					
	(ii)	Aluminium framed glass swing door (for the following units):		Aluminium and tempered glass	Lockset with handle and door hinge		
		Tower 3	Units H, J, K, M & N				
Tower 5 (5A)		Units K, M & N					
Tower 5 (5B)	Units C, D, E, F, G, H, J & K						
Utility Platform Door	Aluminium framed glass swing door		Aluminium and tempered glass	Lockset with handle and door hinge			
Roof Door	Metal gate with aluminium claddings		Fluorocarbon coated aluminum frame	Lockset and door hinge			

Note: 4/F, 13/F, 14/F and 24/F are omitted.

## 3. 室內裝置

細項		描述						
		用料		裝修物料	配件			
(a)	門	單位入口大門	實心防火木掩門及木門框		木皮飾面	電子門鎖連門把手、門鉸、門鼓、門擋、防盜眼、門底密封條及防煙條		
		主人睡房、睡房及儲物室2門	空心木掩門及木門框		木皮飾面	門鎖連門把手、門鉸及門擋		
		主人浴室及浴室門	(i)	空心木掩門及木門框配木百葉 (以下指明單位除外)：		木皮飾面	門鎖連門把手、門鉸及門擋	
				空心木掩門及木門框 (以下指明單位)：				
			(ii)	第3座	主人浴室			單位 A
					浴室			單位 A、G 及 H
		第5座(5A)	主人浴室	單位 C				
			浴室	單位 A				
		廚房門	實心防火木掩門及木門框		木皮飾面	門鎖連門把手、門鉸、門鼓、門擋、防火玻璃視窗、門底密封條及防煙條		
		衣帽間門	空心木趟門及木門框		木皮飾面	門鎖連門把手及趟門路軌		
		露台門、露台及工作平台門、平台門、平台及花園門	(i)	鋁框玻璃趟門 (以下指明單位)：		鋁框及強化玻璃	門鎖連門把手及趟門路軌	
				第3座	單位 A、B、C、D、E、F 及 G			
				第5座(5A)	單位 A、B、C、D、E、F、G、H、J、P、Q 及 R			
第5座(5B)	單位 A、B、M 及 N							
(ii)	鋁框玻璃掩門 (以下指明單位)：		鋁框及強化玻璃	門鎖連門把手及門鉸				
	第3座				單位 H、J、K、M 及 N			
	第5座(5A)	單位 K、M 及 N						
第5座(5B)	單位 C、D、E、F、G、H、J 及 K							
工作平台門	鋁框玻璃掩門		鋁框及強化玻璃	門鎖連門把手及門鉸				
天台門	金屬閘門連鋁質蓋板		氟碳噴塗鋁框	門鎖及門鉸				

備註：不設4樓、13樓、14樓及24樓。

## 3. Interior fittings

Item		Description				
		Fittings & Equipment		Material		
(b)	Bathroom	(i) Types and materials of fittings and equipment	Cabinet	Countertop	Artificial stone	
				Vanity cabinet	Timber cabinet with plastic laminate finish and metal	
				Mirror cabinet	Timber cabinet with mirror, plastic laminate finish and metal, fitted with LED lighting	
			Bathroom fittings	Water closet	Vitreous china	
				Wash basin	Vitreous china	
				Basin mixer	Chrome plated	
				Toilet Paper Holder	Chrome plated	
				Robe hook	Chrome plated	
			Bathroom appliance	For the appliances provision and brand name, please refer to the "Appliances Schedule"		
			(ii) Type and material of water supply system	Cold water supply		Copper water pipes
		Hot water supply		Copper water pipes with thermal insulation		
		Flush water system		uPVC pipes		
		(iii) Type and material of bathing facilities (including shower or bath tub, if applicable)	Shower	Shower mixer set	Chrome plated	
				Shower compartment	Tempered glass	
			Bath tub	Bath tub mixer set	Chrome plated	
				Bath tub	Press Steel	
				Bath tub curtain track	Plastic	
		(iv) Size of bath tub, (if applicable)	1500mm(L) x 700mm(W) x 390mm(H) (Applicable to all bathrooms fitted with bath tub)			

Note: 4/F, 13/F, 14/F and 24/F are omitted.

## 3. 室內裝置

細項		描述			
		裝置及設備		用料	
(b)	浴室	(i) 裝置及設備的類型及用料	櫃	櫃檯面	人造石
				面盆櫃	木製櫃配膠板飾面及金屬
				鏡櫃	木製櫃配鏡、膠板飾面及金屬、設 LED 燈
			浴室裝置	座廁	陶瓷
				洗手盆	陶瓷
				洗手盆水龍頭	鍍鉻
				廁紙架	鍍鉻
				掛鈎	鍍鉻
			浴室設備	有關設備及品牌，請參閱「設備說明表」	
		(ii) 供水系統的類型及用料	冷水供應系統		銅喉管
			熱水供應系統		隔熱絕緣保護之銅喉管
			沖廁水系統		膠喉管
		(iii) 沐浴設施 (包括花灑或浴缸，如適用的話)	花灑	花灑水龍頭及花灑套裝	鍍鉻
				淋浴間	強化玻璃
			浴缸	浴缸水龍頭及花灑套裝	鍍鉻
				浴缸	沖壓鋼
				浴缸簾導軌	塑料
		(iv) 浴缸大小 (如適用的話)	1500 毫米 (長) x 700 毫米 (闊) x 390 毫米 (高) (適用於所有設有浴缸的浴室)		

備註：不設 4 樓、13 樓、14 樓及 24 樓。

## 3. Interior fittings

Item		Description		
		Material		
(c)	Kitchen	(i) Material of sink unit	Stainless steel	
		(ii) Material of water supply system	Cold water supply	Copper water pipes
			Hot water supply	Copper water pipes with thermal insulation
		(iii) Material and finishes of kitchen cabinet	Wooden cabinet	Ecological board doors panel with plastic laminate finish, metal handle and metal skirting
				Medium-density fiberboard doors panel with high gloss lacquer paint finish and metal handle
		(iv) Type of all other fittings and equipment	Other fittings	Chrome plated sink mixer
			Other equipment	Sprinkler head(s) and sounder-based smoke detector(s) installed in all units with open kitchen
Kitchen appliance	For the appliances provision and brand name, please refer to the "Appliances Schedule"			
(d)	Bedroom	Type and material of fittings (including built-in wardrobe)	Not applicable	

Note: 4/F, 13/F, 14/F and 24/F are omitted.

## 3. 室內裝置

細項		描述		
			用料	
(c)	廚房	(i) 洗滌盆的用料	不銹鋼	
		(ii) 供水系統的用料	冷水供應系統	銅喉管
			熱水供應系統	隔熱絕緣保護之銅喉管
		(iii) 廚櫃的用料及裝修物料	木製廚櫃	生態板櫃門板配膠板飾面，金屬把手及金屬腳線
				中級密度纖維板櫃門板配高光度油漆飾面及金屬把手
		(iv) 所有其他裝置及設備的類型	其他裝置	鍍鉻冷熱水龍頭
其他設備	消防花灑頭及配有聲響警報基座的消防煙霧偵測器安裝在開放式廚房的單位			
廚房設備	有關設備及品牌，請參閱「設備說明表」			
(d)	睡房	裝置（包括嵌入式衣櫃）的類型及用料	不適用	

備註：不設4樓、13樓、14樓及24樓。

## 3. Interior fittings

Item		Description	
		Type	
(e)	Telephone	Location and number of connection points	Please refer to the "Schedule of Electrical & Mechanical Provisions of Residential Units"
(f)	Aerials	Location and number of connection points	Please refer to the "Schedule of Electrical & Mechanical Provisions of Residential Units"
(g)	Electrical Installations	(i) Electrical fittings (Including safety devices)	Electrical fittings   Please refer to the "Schedule of Electrical & Mechanical Provisions of Residential Units" Safety devices   Three phases electricity supply with distribution boards are provided in all units
		(ii) Whether conduits are concealed or exposed	Some conduits are concealed in walls, some are exposed and enclosed in false ceilings, bulkheads and cabinets for lightings and power points
		(iii) Location and number of power points and air-conditioner connection points	Please refer to the "Schedule of Electrical & Mechanical Provisions of Residential Units"
(h)	Gas supply	(i) Type	Town gas
		(ii) System	Gas piping is provided and connected to gas hob
		(iii) Location	Please refer to the "Schedule of Electrical & Mechanical Provisions of Residential Units"
(i)	Washing machine connection point	(i) Location	22mm-diameter water supply connection point and 40mm-diameter drainage connection point are provided for washing machine
		(ii) Design	Please refer to the "Schedule of Electrical & Mechanical Provisions of Residential Units"
(j)	Water Supply	(i) Material of water pipes	Copper water pipes are provided for cold water supply. Copper water pipes with thermal insulation provided for hot water supply
		(ii) Whether water pipes are concealed or exposed	Water pipes are partly concealed and partly exposed* * Remarks: Other than those parts of the water pipes concealed within concrete, the rest of them are exposed. The exposed water pipes may be covered or hidden by false ceilings, bulkheads, cabinets, claddings, non-concrete partition walls, designated pipe ducts or other materials
		(iii) Whether hot water is available	Hot water supply to Open Kitchen, Kitchen, Master Bathroom and Bathroom

Note: 4/F, 13/F, 14/F and 24/F are omitted.

## 3. 室內裝置

細項		描述	
		類型	
(e)	電話	接駁點的位置及數量	請參考「住宅單位機電裝置數量說明表」
(f)	天線	接駁點的位置及數量	請參考「住宅單位機電裝置數量說明表」
(g)	電力裝置	(i) 供電附件 (包括安全裝置)	電力裝置 請參考「住宅單位機電裝置數量說明表」 安全裝置 三相電力供應並裝妥配電箱提供於所有單位
		(ii) 導管是隱藏或是外露	部份供電之導管隱藏於牆身。而部份外露並掩蓋於假天花、假陣內及櫃內至照明及供電
		(iii) 電插座及空調機接駁點的位置及數量	請參考「住宅單位機電裝置數量說明表」
(h)	氣體供應	(i) 類型	煤氣
		(ii) 系統	煤氣喉接駁至煤氣煮食爐
		(iii) 位置	請參考「住宅單位機電裝置數量說明表」
(i)	洗衣機接駁點	(i) 位置	請參考「住宅單位機電裝置數量說明表」
		(ii) 設計	設有直徑 22 毫米來去水接駁點及直徑 40 毫米去水接駁點供洗衣機使用
(j)	供水	(i) 水管的用料	冷水喉採用銅喉及熱水喉採用配有隔熱絕緣保護之銅喉
		(ii) 水管是隱藏或是外露	水管是部分隱藏及部分外露 * * 備註：除部分隱藏於混凝土內之水管外，其他部分的水管均為外露。外露的水管可能被假天花、假陣、貯存櫃、蓋板、非混凝土間牆、指定之槽位或其他物料遮蓋或隱藏
		(iii) 有否熱水供應	開放式廚房、廚房、主人浴室及浴室有熱水供應

備註：不設 4 樓、13 樓、14 樓及 24 樓。



## 4. Miscellaneous

Item		Description					
(a)	Lifts		Lift Number	Number of lifts	Brand name	Model Number	Floors served by the lifts
		Tower 3	L10	1	Schindler	55MMR	G/F, 1/F, P/F, 3/F, 5/F - 12/F, 15/F - 23/F, 25/F and 26/F
			L11	1	Schindler		G/F, 1/F, P/F, 3/F, 5/F - 12/F, 15/F - 23/F, 25/F and 26/F
			L12	1	Schindler		G/F, 1/F, P/F, 3/F, 5/F - 12/F, 15/F - 23/F, 25/F and 26/F
		Tower 5 (5A)	L13	1	Schindler	55MMR	G/F, 1/F, P/F, 3/F, 5/F - 12/F, 15/F - 23/F, 25/F and 26/F
			L14	1	Schindler		P/F, 3/F, 5/F - 12/F, 15/F - 23/F, 25/F and 26/F
			L15	1	Schindler		P/F, 3/F, 5/F - 12/F, 15/F - 23/F, 25/F and 26/F
		Tower 5 (5B)	L16	1	Schindler	55MMR	P/F, 3/F, 5/F - 12/F, 15/F - 23/F, 25/F and 26/F
			L17	1	Schindler		P/F, 7/F - 12/F, 15/F - 23/F, 25/F and 26/F
			L18	1	Schindler		P/F, 7/F - 12/F, 15/F - 23/F, 25/F and 26/F
		Podium	L19	1	Schindler	55MRL	G/F and P/F
			L20	1	Schindler		G/F and P/F
		Clubhouse	L24	1	Schindler		G/F, 1/F, UPPER 1/F, P/F and 3/F
(b)	Letter Box	Material	Plastic laminate finish				
(c)	Refuse Collection	(i) Means of refuse collection	Collected by cleaners from refuse storage and material recovery room				
		(ii) Location of refuse room	Refuse storage and material recovery room is provided in the common area of each residential floor. Refuse storage and material recovery chamber is provided on G/F				
(d)	Water Meter, Electricity Meter and Gas Meter		Water meter	Electricity meter		Gas Meter	
		(i) Location	Water meter cabinet on each residential floor	Electrical meter room on each residential floor		Please refer to the "Schedule of Electrical & Mechanical Provisions of Residential Units"	
		(ii) Whether they are separate or communal meters for residential properties	Separate meter	Separate meter		Separate meter	

The Vendor undertakes that if lifts or appliances of the specified brand name or model number are not installed in the Phase, lifts or appliances of comparable quality will be installed.

Note: 4/F, 13/F, 14/F and 24/F are omitted.

## 4. 雜項

細項		描述					
(a)	升降機		升降機號碼	升降機的數目	品牌名稱	產品型號	升降機到達的樓層
		第3座	L10	1	迅達	55MMR	地下、1樓、平台層、3樓、5樓至12樓、15樓至23樓、25樓及26樓
			L11	1	迅達		地下、1樓、平台層、3樓、5樓至12樓、15樓至23樓、25樓及26樓
			L12	1	迅達		地下、1樓、平台層、3樓、5樓至12樓、15樓至23樓、25樓及26樓
		第5座(5A)	L13	1	迅達	55MMR	地下、1樓、平台層、3樓、5樓至12樓、15樓至23樓、25樓及26樓
			L14	1	迅達		平台層、3樓、5樓至12樓、15樓至23樓、25樓及26樓
			L15	1	迅達		平台層、3樓、5樓至12樓、15樓至23樓、25樓及26樓
		第5座(5B)	L16	1	迅達	55MMR	平台層、3樓、5樓至12樓、15樓至23樓、25樓及26樓
			L17	1	迅達		平台層、7樓至12樓、15樓至23樓、25樓及26樓
			L18	1	迅達		平台層、7樓至12樓、15樓至23樓、25樓及26樓
		大廈基座	L19	1	迅達	55MRL	地下及平台層
			L20	1	迅達		地下及平台層
		會所	L24	1	迅達		地下、1樓、1樓上層、平台層及3樓
		(b)	信箱	用料	膠板飾面		
(c)	垃圾收集	(i) 垃圾收集方法	由清潔工人於垃圾及物料回收室收集				
		(ii) 垃圾房的位置	各住宅樓層之公用地方均設有垃圾及物料回收室；另中央垃圾及物料收集房設於地下				
(d)	水錶，電錶及氣體錶		水錶	電錶	氣體錶		
		(i) 位置	每層住宅樓層之水錶櫃	每層住宅樓層之電錶房	請參考「住宅單位機電裝置數量說明表」		
		(ii) 就住宅單位而言是獨立抑或公用的錶	獨立錶	獨立錶	獨立錶		

賣方承諾如期數中沒有安裝指明的品牌名稱或產品型號的升降機或設備，便會安裝品質相若的升降機或設備。

備註：不設4樓、13樓、14樓及24樓。

**5. Security facilities**

Item	Description	
Security System and Equipment (including details of built-in provisions and their locations)	(i) Access control and security system:	Each residential unit is equipped with a video door phone system and connected to caretaker counter at the P/F respective entrance lobbies (Please refer to the “Appliances Schedule” for location of video door phone in residential unit)
		Smart card readers are installed at each lift lobby of residential entrance at G/F and P/F
		Carpark control system is provided. Carpark barrier gate is provided at G/F vehicle entrance
	(ii) CCTV	CCTV cameras are provided at main entrance lobbies, lifts and common area and connected to the management office

**6. Appliances**

Item	Description
Brand name and model number	For Brand name and model number, please refer to “Appliances Schedule”

The Vendor undertakes that if lifts or appliances of the specified brand name or model number are not installed in the Phase, lifts or appliances of comparable quality will be installed.

Note: 4/F, 13/F, 14/F and 24/F are omitted.

## 5. 保安設施

細項	描述	
保安系統及設備 (包括嵌入式的裝備的細節及其位置)	(i) 入口通道控制及保安系統	每戶單位設有門口視像對講機並連接各大廈位於平台層入口大堂服務員櫃台 (有關住宅單位視像對講機位置，請參閱「設備說明表」)
		地下及平台層住宅大樓之入口升降機大堂均設有智能卡系統
		設有停車場管理系統，車閘設於地下車輛入口
	(ii) 閉路電視	閉路電視設於主要入口大堂、升降機內及公用地方並連接至管理處

## 6. 設備

細項	描述
品牌名稱及產品型號	有關設備的品牌名稱及產品型號，請參閱「設備說明表」

賣方承諾如期數中沒有安裝指明的品牌名稱或產品型號的升降機或設備，便會安裝品質相若的升降機或設備。

備註：不設4樓、13樓、14樓及24樓。

Appliances Schedule 設備說明表

Location 位置	Appliances 設備	Brand Name 品牌名稱	Model Number 產品型號	Tower 3 第3座 Floor and Unit 樓層及單位 3/F 3樓									
				B	C	D	E	F	G	H	J	K	
Living Room and Dining Room 客廳及飯廳	Video Door Phone 視像對講機	SUPERTECH	ST-C315	✓	✓	✓	✓	✓	✓	✓	✓	✓	✓
	Air-conditioning Indoor Unit 空調室內機	Mitsubishi Heavy Industries 三菱重工	SRK50ZSX-WF	-	-	-	-	-	-	-	✓	✓	✓
	Air-conditioning Indoor Unit 空調室內機	Mitsubishi Heavy Industries 三菱重工	SRK60ZSX-WF	✓	✓	✓	✓	✓	✓	✓	✓	✓	✓
	7 in 1 Steam Oven with Microwave 7合1微波蒸烤焗爐	Siemens 西門子	CP269AGS0K	-	-	-	-	-	-	-	-	✓	✓
	Refrigerator 雪櫃	Whirlpool 惠而浦	ARG8627A	-	-	-	-	-	-	-	-	✓	✓
	Refrigerator 雪櫃	Whirlpool 惠而浦	WHC18T311HK	✓	-	✓	✓	✓	✓	✓	-	-	-
Kitchen or Open Kitchen 廚房或開放式廚房	Gas Hob (1 Burner Gas Hob) 煤氣煮食爐(單頭)	Siemens 西門子	ER3A6AB70X	✓	✓	✓	✓	✓	✓	✓	-	-	-
	Gas Hob (2 Burners Gas Hob) 煤氣煮食爐(雙頭)	Siemens 西門子	ER3A6BB70X	✓	✓	✓	✓	✓	✓	✓	✓	✓	✓
	Cooker Hood 抽油煙機	Siemens 西門子	LI67SA531B	-	-	-	-	-	-	-	✓	✓	✓
	Cooker Hood 抽油煙機	Siemens 西門子	LI97SA531B	✓	✓	✓	✓	✓	✓	✓	-	-	-
	Refrigerator 雪櫃	Whirlpool 惠而浦	ARG8627A	-	-	-	-	-	-	-	✓	-	-
	Refrigerator 雪櫃	Whirlpool 惠而浦	WHC18T311HK	-	✓	-	-	-	-	-	-	-	-

The Vendor undertakes that if lifts or appliances of the specified brand name or model number are not installed in the Phase, lifts or appliances of comparable quality will be installed.

賣方承諾如期數中沒有安裝指明的品牌名稱或產品型號的升降機或設備，便會安裝品質相若的升降機或設備。

## Notes:

1. The symbol "✓" as shown in the above table denotes "Provided".
2. The symbol "-" as shown in the above table denotes "Not Provided".
3. The symbol "/" as shown in the above table denotes "Not Applicable".
4. 4/F, 13/F, 14/F and 24/F are omitted.

## 備註:

1. 上表 "✓" 代表「提供」。
2. 上表 "-" 代表「不提供」。
3. 上表 "/" 代表「不適用」。
4. 不設4樓、13樓、14樓及24樓。

Appliances Schedule 設備說明表

Location 位置	Appliances 設備	Brand Name 品牌名稱	Model Number 產品型號	Tower 3 第3座 Floor and Unit 樓層及單位 3/F 3樓								
				B	C	D	E	F	G	H	J	K
Kitchen or Open Kitchen 廚房或開放式廚房	7 in 1 Steam Oven with Microwave 7合1微波蒸烤焗爐	Siemens 西門子	CP269AGS0K	✓	✓	✓	✓	✓	✓	✓	-	-
	Washer/Dryer 洗衣 / 乾衣機	Whirlpool 惠而浦	WFCI75430	✓	✓	✓	✓	✓	✓	✓	✓	✓
	Electric Water Heater 電熱水爐	Stiebel Eltron 斯寶亞創	DHM6	✓	✓	✓	✓	✓	✓	✓	✓	✓
Bedroom 睡房	Air-conditioning Indoor Unit 空調室內機	Mitsubishi Heavy Industries 三菱重工	SRK25ZSX-WF	✓	-	✓	-	-	✓	/	/	/
	Air-conditioning Indoor Unit 空調室內機	Mitsubishi Heavy Industries 三菱重工	SRK35ZSX-WF	-	✓	-	✓	✓	-	/	/	/
Master Bedroom 主人睡房	Air-conditioning Indoor Unit 空調室內機	Mitsubishi Heavy Industries 三菱重工	SRK35ZSX-WF	-	✓	-	✓	✓	-	/	/	/
	Air-conditioning Indoor Unit 空調室內機	Mitsubishi Heavy Industries 三菱重工	SRK50ZSX-WF	✓	-	✓	-	-	✓	/	/	/
Bathroom 浴室	Thermo Ventilator 浴室寶	Panasonic 樂聲牌	FV40BEN4H	✓	✓	✓	✓	✓	✓	✓	✓	✓
	Electric Water Heater 電熱水爐	Stiebel Eltron 斯寶亞創	DHB 21 ST Trend	✓	✓	✓	✓	✓	✓	✓	✓	✓
	Exhaust Fan 抽氣扇	Ostberg	RFE140 AKU	✓	✓	✓	✓	✓	-	-	✓	✓
Store Room 2 儲物室 2	Air-conditioning Indoor Unit 空調室內機	Mitsubishi Heavy Industries 三菱重工	SRK20ZSX-WF	/	/	/	/	/	✓	/	/	/

The Vendor undertakes that if lifts or appliances of the specified brand name or model number are not installed in the Phase, lifts or appliances of comparable quality will be installed.

賣方承諾如期數中沒有安裝指明的品牌名稱或產品型號的升降機或設備，便會安裝品質相若的升降機或設備。

## Notes:

1. The symbol "✓" as shown in the above table denotes "Provided".
2. The symbol "-" as shown in the above table denotes "Not Provided".
3. The symbol "/" as shown in the above table denotes "Not Applicable".
4. 4/F, 13/F, 14/F and 24/F are omitted.

## 備註:

1. 上表 "✓" 代表「提供」。
2. 上表 "-" 代表「不提供」。
3. 上表 "/" 代表「不適用」。
4. 不設4樓、13樓、14樓及24樓。

Appliances Schedule 設備說明表

Location 位置	Appliances 設備	Brand Name 品牌名稱	Model Number 產品型號	Tower 3 第3座 Floor and Unit 樓層及單位 3/F 3樓									
				B	C	D	E	F	G	H	J	K	
Flat Roof 平台	Air-conditioning Outdoor Unit 空調室外機	Mitsubishi Heavy Industries 三菱重工	SCM125ZM-S	✓	✓	-	✓	✓	✓	-	-	-	
Inaccessible Common Flat Roof 維修平台	Air-conditioning Outdoor Unit 空調室外機	Mitsubishi Heavy Industries 三菱重工	SCM125ZM-S	/	/	✓	/	/	/	✓	✓	/	
Common Planter 公用花槽	Air-conditioning Outdoor Unit 空調室外機	Mitsubishi Heavy Industries 三菱重工	SCM125ZM-S	/	/	/	/	/	/	/	/	✓	

The Vendor undertakes that if lifts or appliances of the specified brand name or model number are not installed in the Phase, lifts or appliances of comparable quality will be installed.  
賣方承諾如期數中沒有安裝指明的品牌名稱或產品型號的升降機或設備，便會安裝品質相若的升降機或設備。

## Notes:

1. The symbol "✓" as shown in the above table denotes "Provided".
2. The symbol "-" as shown in the above table denotes "Not Provided".
3. The symbol "/" as shown in the above table denotes "Not Applicable".
4. 4/F, 13/F, 14/F and 24/F are omitted.

## 備註：

1. 上表“✓”代表「提供」。
2. 上表“-”代表「不提供」。
3. 上表“/”代表「不適用」。
4. 不設4樓、13樓、14樓及24樓。

Appliances Schedule 設備說明表

Location 位置	Appliances 設備	Brand Name 品牌名稱	Model Number 產品型號	Tower 3 第3座 Floor and Unit 樓層及單位 5/F 5樓												
				A	B	C	D	E	F	G	H	J	K	M	N	
Living Room and Dining Room 客廳及飯廳	Video Door Phone 視像對講機	SUPERTECH	ST-C315	✓	✓	✓	✓	✓	✓	✓	✓	✓	✓	✓	✓	
	Air-conditioning Indoor Unit 空調室內機	Mitsubishi Heavy Industries 三菱重工	SRK50ZSX-WF	-	-	-	-	-	-	-	-	✓	✓	✓	✓	
	Air-conditioning Indoor Unit 空調室內機	Mitsubishi Heavy Industries 三菱重工	SRK60ZSX-WF	✓	✓	✓	✓	✓	✓	✓	✓	✓	✓	✓	✓	
	7 in 1 Steam Oven with Microwave 7合1微波蒸烤焗爐	Siemens 西門子	CP269AGS0K	-	-	-	-	-	-	-	-	-	✓	✓	✓	✓
	Refrigerator 雪櫃	Whirlpool 惠而浦	ARG8627A	-	-	-	-	-	-	-	-	-	✓	✓	✓	✓
	Refrigerator 雪櫃	Whirlpool 惠而浦	WHC18T311HK	-	✓	-	✓	✓	✓	✓	✓	-	-	-	-	-
Kitchen or Open Kitchen 廚房或開放式廚房	Gas Hob (1 Burner Gas Hob) 煤氣煮食爐(單頭)	Siemens 西門子	ER3A6AB70X	✓	✓	✓	✓	✓	✓	✓	✓	-	-	-	-	
	Gas Hob (2 Burners Gas Hob) 煤氣煮食爐(雙頭)	Siemens 西門子	ER3A6BB70X	✓	✓	✓	✓	✓	✓	✓	✓	✓	✓	✓	✓	
	Cooker Hood 抽油煙機	Siemens 西門子	LI67SA531B	-	-	-	-	-	-	-	-	✓	✓	✓	✓	
	Cooker Hood 抽油煙機	Siemens 西門子	LI97SA531B	✓	✓	✓	✓	✓	✓	✓	✓	-	-	-	-	
	Refrigerator 雪櫃	Whirlpool 惠而浦	ARG8627A	-	-	-	-	-	-	-	-	✓	-	-	-	
	Refrigerator 雪櫃	Whirlpool 惠而浦	WHC18T311HK	✓	-	✓	-	-	-	-	-	-	-	-	-	

The Vendor undertakes that if lifts or appliances of the specified brand name or model number are not installed in the Phase, lifts or appliances of comparable quality will be installed.

賣方承諾如期數中沒有安裝指明的品牌名稱或產品型號的升降機或設備，便會安裝品質相若的升降機或設備。

## Notes:

1. The symbol "✓" as shown in the above table denotes "Provided".
2. The symbol "-" as shown in the above table denotes "Not Provided".
3. The symbol "/" as shown in the above table denotes "Not Applicable".
4. 4/F, 13/F, 14/F and 24/F are omitted.

## 備註:

1. 上表 "✓" 代表「提供」。
2. 上表 "-" 代表「不提供」。
3. 上表 "/" 代表「不適用」。
4. 不設4樓、13樓、14樓及24樓。



Appliances Schedule 設備說明表

Location 位置	Appliances 設備	Brand Name 品牌名稱	Model Number 產品型號	Tower 3 第3座 Floor and Unit 樓層及單位 5/F 5樓												
				A	B	C	D	E	F	G	H	J	K	M	N	
Kitchen or Open Kitchen 廚房或開放式廚房	7 in 1 Steam Oven with Microwave 7合1微波蒸烤焗爐	Siemens 西門子	CP269AGS0K	✓	✓	✓	✓	✓	✓	✓	✓	✓	-	-	-	-
	Microwave Oven with Grill 微波燒烤爐	Siemens 西門子	BE732L1B1B	✓	-	-	-	-	-	-	-	-	-	-	-	-
	Washer/Dryer 洗衣 / 乾衣機	Whirlpool 惠而浦	WFCI75430	✓	✓	✓	✓	✓	✓	✓	✓	✓	✓	✓	✓	✓
	Wine Cellar 酒櫃	Vinvautz	VZ07SSUG	✓	-	-	-	-	-	-	-	-	-	-	-	-
	Electric Water Heater 電熱水爐	Stiebel Eltron 斯寶亞創	DHM6	✓	✓	✓	✓	✓	✓	✓	✓	✓	✓	✓	✓	✓
	Exhaust Fan 抽氣扇	Ostberg	RFE140 BKU	✓	-	-	-	-	-	-	-	-	-	-	-	-
Bedroom 睡房	Air-conditioning Indoor Unit 空調室內機	Mitsubishi Heavy Industries 三菱重工	SRK25ZSX-WF	/	✓	-	✓	-	-	✓	/	/	/	/	/	
	Air-conditioning Indoor Unit 空調室內機	Mitsubishi Heavy Industries 三菱重工	SRK35ZSX-WF	/	-	✓	-	✓	✓	-	/	/	/	/	/	
Bedroom 1 睡房 1	Air-conditioning Indoor Unit 空調室內機	Mitsubishi Heavy Industries 三菱重工	SRK25ZSX-WF	✓	/	/	/	/	/	/	/	/	/	/	/	
Bedroom 2 睡房 2	Air-conditioning Indoor Unit 空調室內機	Mitsubishi Heavy Industries 三菱重工	SRK25ZSX-WF	✓	/	/	/	/	/	/	/	/	/	/	/	

The Vendor undertakes that if lifts or appliances of the specified brand name or model number are not installed in the Phase, lifts or appliances of comparable quality will be installed.

賣方承諾如期數中沒有安裝指明的品牌名稱或產品型號的升降機或設備，便會安裝品質相若的升降機或設備。

## Notes:

1. The symbol "✓" as shown in the above table denotes "Provided".
2. The symbol "-" as shown in the above table denotes "Not Provided".
3. The symbol "/" as shown in the above table denotes "Not Applicable".
4. 4/F, 13/F, 14/F and 24/F are omitted.

## 備註:

1. 上表 "✓" 代表「提供」。
2. 上表 "-" 代表「不提供」。
3. 上表 "/" 代表「不適用」。
4. 不設4樓、13樓、14樓及24樓。

Appliances Schedule 設備說明表

Location 位置	Appliances 設備	Brand Name 品牌名稱	Model Number 產品型號	Tower 3 第3座 Floor and Unit 樓層及單位 5/F 5樓											
				A	B	C	D	E	F	G	H	J	K	M	N
Master Bedroom 主人睡房	Air-conditioning Indoor Unit 空調室內機	Mitsubishi Heavy Industries 三菱重工	SRK35ZSX-WF	-	-	✓	-	✓	✓	-	/	/	/	/	/
	Air-conditioning Indoor Unit 空調室內機	Mitsubishi Heavy Industries 三菱重工	SRK50ZSX-WF	-	✓	-	✓	-	-	✓	/	/	/	/	/
	Air-conditioning Indoor Unit 空調室內機	Mitsubishi Heavy Industries 三菱重工	SRK60ZSX-WF	✓	-	-	-	-	-	-	/	/	/	/	/
Bathroom 浴室	Thermo Ventilator 浴室寶	Panasonic 樂聲牌	FV40BEN4H	✓	✓	✓	✓	✓	✓	✓	✓	✓	✓	✓	✓
	Electric Water Heater 電熱水爐	Stiebel Eltron 斯寶亞創	DHB 21 ST Trend	✓	✓	✓	✓	✓	✓	✓	✓	✓	✓	✓	✓
	Exhaust Fan 抽氣扇	Ostberg	RFE140 AKU	✓	✓	✓	✓	✓	✓	-	-	✓	✓	✓	-
Master Bathroom 主人浴室	Thermo Ventilator 浴室寶	Panasonic 樂聲牌	FV40BEN4H	✓	/	/	/	/	/	/	/	/	/	/	/
	Electric Water Heater 電熱水爐	Stiebel Eltron 斯寶亞創	DHB 21 ST Trend	✓	/	/	/	/	/	/	/	/	/	/	/
	Exhaust Fan 抽氣扇	Ostberg	RFE140 AKU	✓	/	/	/	/	/	/	/	/	/	/	/
Store Room 2 儲物室2	Air-conditioning Indoor Unit 空調室內機	Mitsubishi Heavy Industries 三菱重工	SRK20ZSX-WF	/	/	/	/	/	/	✓	/	/	/	/	/
Air Conditioner Platform 冷氣機平台	Air-conditioning Outdoor Unit 空調室外機	Mitsubishi Heavy Industries 三菱重工	SCM125ZM-S	/	✓	✓	✓	✓	✓	✓	✓	✓	✓	✓	✓

The Vendor undertakes that if lifts or appliances of the specified brand name or model number are not installed in the Phase, lifts or appliances of comparable quality will be installed.

賣方承諾如期數中沒有安裝指明的品牌名稱或產品型號的升降機或設備，便會安裝品質相若的升降機或設備。

## Notes:

1. The symbol "✓" as shown in the above table denotes "Provided".
2. The symbol "-" as shown in the above table denotes "Not Provided".
3. The symbol "/" as shown in the above table denotes "Not Applicable".
4. 4/F, 13/F, 14/F and 24/F are omitted.

## 備註:

1. 上表 "✓" 代表「提供」。
2. 上表 "-" 代表「不提供」。
3. 上表 "/" 代表「不適用」。
4. 不設4樓、13樓、14樓及24樓。

Appliances Schedule 設備說明表

Location 位置	Appliances 設備	Brand Name 品牌名稱	Model Number 產品型號	Tower 3 第3座 Floor and Unit 樓層及單位 5/F 5樓											
				A	B	C	D	E	F	G	H	J	K	M	N
Flat Roof 平台	Air-conditioning Outdoor Unit 空調室外機	Mitsubishi Heavy Industries 三菱重工	SRC60ZSXH-S	✓	/	/	/	/	/	/	/	/	/	-	-
	Air-conditioning Outdoor Unit 空調室外機	Mitsubishi Heavy Industries 三菱重工	SCM125ZM-S	✓	/	/	/	/	/	/	/	/	/	-	-

The Vendor undertakes that if lifts or appliances of the specified brand name or model number are not installed in the Phase, lifts or appliances of comparable quality will be installed.  
賣方承諾如期數中沒有安裝指明的品牌名稱或產品型號的升降機或設備，便會安裝品質相若的升降機或設備。

## Notes:

1. The symbol "✓" as shown in the above table denotes "Provided".
2. The symbol "-" as shown in the above table denotes "Not Provided".
3. The symbol "/" as shown in the above table denotes "Not Applicable".
4. 4/F, 13/F, 14/F and 24/F are omitted.

## 備註：

1. 上表“✓”代表「提供」。
2. 上表“-”代表「不提供」。
3. 上表“/”代表「不適用」。
4. 不設4樓、13樓、14樓及24樓。

Appliances Schedule 設備說明表

Location 位置	Appliances 設備	Brand Name 品牌名稱	Model Number 產品型號	Tower 3 第3座 Floor and Unit 樓層及單位 6/F - 12/F, 15/F - 23/F & 25/F - 26/F 6樓至12樓、15樓至23樓及25樓至26樓												
				A	B	C	D	E	F	G	H	J	K	M	N	
Living Room and Dining Room 客廳及飯廳	Video Door Phone 視像對講機	SUPERTECH	ST-C315	✓	✓	✓	✓	✓	✓	✓	✓	✓	✓	✓	✓	
	Air-conditioning Indoor Unit 空調室內機	Mitsubishi Heavy Industries 三菱重工	SRK50ZSX-WF	-	-	-	-	-	-	-	-	✓	✓	✓	✓	
	Air-conditioning Indoor Unit 空調室內機	Mitsubishi Heavy Industries 三菱重工	SRK60ZSX-WF	✓	✓	✓	✓	✓	✓	✓	✓	✓	✓	✓	✓	
	7 in 1 Steam Oven with Microwave 7合1微波蒸烤焗爐	Siemens 西門子	CP269AGS0K	-	-	-	-	-	-	-	-	-	✓	✓	✓	✓
	Refrigerator 雪櫃	Whirlpool 惠而浦	ARG8627A	-	-	-	-	-	-	-	-	-	✓	✓	✓	✓
	Refrigerator 雪櫃	Whirlpool 惠而浦	WHC18T311HK	-	✓	-	✓	✓	✓	✓	✓	-	-	-	-	-
Kitchen or Open Kitchen 廚房或開放式廚房	Gas Hob (1 Burner Gas Hob) 煤氣煮食爐(單頭)	Siemens 西門子	ER3A6AB70X	✓	✓	✓	✓	✓	✓	✓	✓	-	-	-	-	
	Gas Hob (2 Burners Gas Hob) 煤氣煮食爐(雙頭)	Siemens 西門子	ER3A6BB70X	✓	✓	✓	✓	✓	✓	✓	✓	✓	✓	✓	✓	
	Cooker Hood 抽油煙機	Siemens 西門子	LI67SA531B	-	-	-	-	-	-	-	-	✓	✓	✓	✓	
	Cooker Hood 抽油煙機	Siemens 西門子	LI97SA531B	✓	✓	✓	✓	✓	✓	✓	✓	-	-	-	-	
	Refrigerator 雪櫃	Whirlpool 惠而浦	ARG8627A	-	-	-	-	-	-	-	-	✓	-	-	-	
	Refrigerator 雪櫃	Whirlpool 惠而浦	WHC18T311HK	✓	-	✓	-	-	-	-	-	-	-	-	-	

The Vendor undertakes that if lifts or appliances of the specified brand name or model number are not installed in the Phase, lifts or appliances of comparable quality will be installed.

賣方承諾如期數中沒有安裝指明的品牌名稱或產品型號的升降機或設備，便會安裝品質相若的升降機或設備。

## Notes:

1. The symbol "✓" as shown in the above table denotes "Provided".
2. The symbol "-" as shown in the above table denotes "Not Provided".
3. The symbol "/" as shown in the above table denotes "Not Applicable".
4. 4/F, 13/F, 14/F and 24/F are omitted.

## 備註:

1. 上表 "✓" 代表「提供」。
2. 上表 "-" 代表「不提供」。
3. 上表 "/" 代表「不適用」。
4. 不設4樓、13樓、14樓及24樓。

Appliances Schedule 設備說明表

Location 位置	Appliances 設備	Brand Name 品牌名稱	Model Number 產品型號	Tower 3 第3座 Floor and Unit 樓層及單位 6/F - 12/F, 15/F - 23/F & 25/F - 26/F 6樓至12樓、15樓至23樓及25樓至26樓											
				A	B	C	D	E	F	G	H	J	K	M	N
Kitchen or Open Kitchen 廚房或開放式廚房	7 in 1 Steam Oven with Microwave 7合1微波蒸烤焗爐	Siemens 西門子	CP269AGS0K	✓	✓	✓	✓	✓	✓	✓	✓	-	-	-	-
	Microwave Oven with Grill 微波燒烤爐	Siemens 西門子	BE732L1B1B	✓	-	-	-	-	-	-	-	-	-	-	-
	Washer/Dryer 洗衣 / 乾衣機	Whirlpool 惠而浦	WFCI75430	✓	✓	✓	✓	✓	✓	✓	✓	✓	✓	✓	✓
	Wine Cellar 酒櫃	Vinvautz	VZ07SSUG	✓	-	-	-	-	-	-	-	-	-	-	-
	Electric Water Heater 電熱水爐	Stiebel Eltron 斯寶亞創	DHM6	✓	✓	✓	✓	✓	✓	✓	✓	✓	✓	✓	✓
	Exhaust Fan 抽氣扇	Ostberg	RFE140 BKU	✓	-	-	-	-	-	-	-	-	-	-	-
Bedroom 睡房	Air-conditioning Indoor Unit 空調室內機	Mitsubishi Heavy Industries 三菱重工	SRK25ZSX-WF	/	✓	-	✓	-	-	✓	/	/	/	/	/
	Air-conditioning Indoor Unit 空調室內機	Mitsubishi Heavy Industries 三菱重工	SRK35ZSX-WF	/	-	✓	-	✓	✓	-	/	/	/	/	/
Bedroom 1 睡房1	Air-conditioning Indoor Unit 空調室內機	Mitsubishi Heavy Industries 三菱重工	SRK25ZSX-WF	✓	/	/	/	/	/	/	/	/	/	/	/
Bedroom 2 睡房2	Air-conditioning Indoor Unit 空調室內機	Mitsubishi Heavy Industries 三菱重工	SRK25ZSX-WF	✓	/	/	/	/	/	/	/	/	/	/	/

The Vendor undertakes that if lifts or appliances of the specified brand name or model number are not installed in the Phase, lifts or appliances of comparable quality will be installed.

賣方承諾如期數中沒有安裝指明的品牌名稱或產品型號的升降機或設備，便會安裝品質相若的升降機或設備。

## Notes:

1. The symbol "✓" as shown in the above table denotes "Provided".
2. The symbol "-" as shown in the above table denotes "Not Provided".
3. The symbol "/" as shown in the above table denotes "Not Applicable".
4. 4/F, 13/F, 14/F and 24/F are omitted.

## 備註:

1. 上表 "✓" 代表「提供」。
2. 上表 "-" 代表「不提供」。
3. 上表 "/" 代表「不適用」。
4. 不設4樓、13樓、14樓及24樓。

Appliances Schedule 設備說明表

Location 位置	Appliances 設備	Brand Name 品牌名稱	Model Number 產品型號	Tower 3 第3座 Floor and Unit 樓層及單位 6/F - 12/F, 15/F - 23/F & 25/F - 26/F 6樓至12樓、15樓至23樓及25樓至26樓											
				A	B	C	D	E	F	G	H	J	K	M	N
Master Bedroom 主人睡房	Air-conditioning Indoor Unit 空調室內機	Mitsubishi Heavy Industries 三菱重工	SRK35ZSX-WF	-	-	✓	-	✓	✓	-	/	/	/	/	/
	Air-conditioning Indoor Unit 空調室內機	Mitsubishi Heavy Industries 三菱重工	SRK50ZSX-WF	-	✓	-	✓	-	-	✓	/	/	/	/	/
	Air-conditioning Indoor Unit 空調室內機	Mitsubishi Heavy Industries 三菱重工	SRK60ZSX-WF	✓	-	-	-	-	-	-	/	/	/	/	/
Bathroom 浴室	Thermo Ventilator 浴室寶	Panasonic 樂聲牌	FV40BEN4H	✓	✓	✓	✓	✓	✓	✓	✓	✓	✓	✓	✓
	Electric Water Heater 電熱水爐	Stiebel Eltron 斯寶亞創	DHB 21 ST Trend	✓	✓	✓	✓	✓	✓	✓	✓	✓	✓	✓	✓
	Exhaust Fan 抽氣扇	Ostberg	RFE140 AKU	✓	✓	✓	✓	✓	✓	-	-	✓	✓	✓	-
Master Bathroom 主人浴室	Thermo Ventilator 浴室寶	Panasonic 樂聲牌	FV40BEN4H	✓	/	/	/	/	/	/	/	/	/	/	/
	Electric Water Heater 電熱水爐	Stiebel Eltron 斯寶亞創	DHB 21 ST Trend	✓	/	/	/	/	/	/	/	/	/	/	/
	Exhaust Fan 抽氣扇	Ostberg	RFE140 AKU	✓	/	/	/	/	/	/	/	/	/	/	/
Store Room 2 儲物室 2	Air-conditioning Indoor Unit 空調室內機	Mitsubishi Heavy Industries 三菱重工	SRK20ZSX-WF	/	/	/	/	/	/	✓	/	/	/	/	/
Air Conditioner Platform 冷氣機平台	Air-conditioning Outdoor Unit 空調室外機	Mitsubishi Heavy Industries 三菱重工	SRC60ZSXH-S	✓	-	-	-	-	-	-	-	-	-	-	-
	Air-conditioning Outdoor Unit 空調室外機	Mitsubishi Heavy Industries 三菱重工	SCM125ZM-S	✓	✓	✓	✓	✓	✓	✓	✓	✓	✓	✓	✓

The Vendor undertakes that if lifts or appliances of the specified brand name or model number are not installed in the Phase, lifts or appliances of comparable quality will be installed.

賣方承諾如期數中沒有安裝指明的品牌名稱或產品型號的升降機或設備，便會安裝品質相若的升降機或設備。

## Notes:

1. The symbol "✓" as shown in the above table denotes "Provided".
2. The symbol "-" as shown in the above table denotes "Not Provided".
3. The symbol "/" as shown in the above table denotes "Not Applicable".
4. 4/F, 13/F, 14/F and 24/F are omitted.

## 備註:

1. 上表 "✓" 代表「提供」。
2. 上表 "-" 代表「不提供」。
3. 上表 "/" 代表「不適用」。
4. 不設4樓、13樓、14樓及24樓。

Appliances Schedule 設備說明表

Location 位置	Appliances 設備	Brand Name 品牌名稱	Model Number 產品型號	Tower 5 (5A) 第5座 (5A) Floor and Unit 樓層及單位 3/F 3樓											
				A	B	C	D	E	F	G	M	N	P	Q	
Living Room and Dining Room 客廳及飯廳	Video Door Phone 視像對講機	SUPERTECH	ST-C315	✓	✓	✓	✓	✓	✓	✓	✓	✓	✓	✓	✓
	Air-conditioning Indoor Unit 空調室內機	Mitsubishi Heavy Industries 三菱重工	SRK50ZSX-WF	-	-	-	-	-	-	✓	✓	-	-	✓	✓
	Air-conditioning Indoor Unit 空調室內機	Mitsubishi Heavy Industries 三菱重工	SRK60ZSX-WF	✓	✓	✓	✓	✓	-	-	-	✓	✓	-	-
	Refrigerator 雪櫃	Whirlpool 惠而浦	ARG8627A	-	-	-	-	-	-	-	-	-	-	✓	✓
	Refrigerator 雪櫃	Whirlpool 惠而浦	WHC18T311HK	✓	-	-	✓	-	-	-	-	-	-	-	-
	7 in 1 Steam Oven with Microwave 7合1微波蒸烤焗爐	Siemens 西門子	CP269AGS0K	-	-	-	-	-	-	-	-	-	-	✓	✓
	Washer / Dryer 洗衣 / 乾衣機	Whirlpool 惠而浦	WFCI75430	✓	-	-	-	-	-	-	-	-	-	-	-
Kitchen or Open Kitchen 廚房或開放式廚房	Gas Hob (1 Burner Gas Hob) 煤氣煮食爐 (單頭)	Siemens 西門子	ER3A6AB70X	✓	✓	✓	✓	✓	-	-	-	-	-	-	-
	Gas Hob (2 Burners Gas Hob) 煤氣煮食爐 (雙頭)	Siemens 西門子	ER3A6BB70X	✓	✓	✓	✓	✓	✓	✓	-	-	✓	✓	
	Induction Hob 電磁煮食爐	Siemens 西門子	EX375FXB1E	-	-	-	-	-	-	-	✓	✓	-	-	
	Cooker Hood 抽油煙機	Siemens 西門子	LI67SA531B	-	-	-	-	-	✓	✓	✓	✓	✓	✓	
	Cooker Hood 抽油煙機	Siemens 西門子	LI97SA531B	✓	✓	✓	✓	✓	-	-	-	-	-	-	

The Vendor undertakes that if lifts or appliances of the specified brand name or model number are not installed in the Phase, lifts or appliances of comparable quality will be installed.

賣方承諾如期數中沒有安裝指明的品牌名稱或產品型號的升降機或設備，便會安裝品質相若的升降機或設備。

## Notes:

1. The symbol "✓" as shown in the above table denotes "Provided".
2. The symbol "-" as shown in the above table denotes "Not Provided".
3. The symbol "/" as shown in the above table denotes "Not Applicable".
4. 4/F, 13/F, 14/F and 24/F are omitted.

## 備註:

1. 上表 "✓" 代表「提供」。
2. 上表 "-" 代表「不提供」。
3. 上表 "/" 代表「不適用」。
4. 不設4樓、13樓、14樓及24樓。

Appliances Schedule 設備說明表

Location 位置	Appliances 設備	Brand Name 品牌名稱	Model Number 產品型號	Tower 5 (5A) 第5座(5A) Floor and Unit 樓層及單位 3/F 3樓										
				A	B	C	D	E	F	G	M	N	P	Q
Kitchen or Open Kitchen 廚房或開放式廚房	Refrigerator 雪櫃	Whirlpool 惠而浦	ARG8627A	-	-	-	-	-	✓	✓	✓	✓	-	-
	Refrigerator 雪櫃	Whirlpool 惠而浦	WHC18T311HK	-	✓	✓	-	✓	-	-	-	-	-	-
	7 in 1 Steam Oven with Microwave 7合1微波蒸烤焗爐	Siemens 西門子	CP269AGS0K	✓	✓	✓	✓	✓	✓	✓	✓	✓	✓	-
	Microwave Oven with Grill 微波燒烤爐	Siemens 西門子	BE732L1B1B	-	-	✓	-	-	-	-	-	-	-	-
	Washer / Dryer 洗衣 / 乾衣機	Whirlpool 惠而浦	WFCI75430	-	✓	✓	✓	✓	✓	✓	✓	✓	✓	✓
	Wine Cellar 酒櫃	Vinvautz	VZ07SSUG	-	-	✓	-	-	-	-	-	-	-	-
	Electric Water Heater 電熱水爐	Stiebel Eltron 斯寶亞創	DHM6	✓	✓	✓	✓	✓	✓	✓	✓	✓	✓	✓
	Exhaust Fan 抽氣扇	Ostberg	RFE140 BKU	-	-	✓	-	-	-	-	-	-	-	-
Bedroom 睡房	Air-conditioning Indoor Unit 空調室內機	Mitsubishi Heavy Industries 三菱重工	SRK25ZSX-WF	✓	-	/	✓	✓	✓	✓	/	/	✓	✓
	Air-conditioning Indoor Unit 空調室內機	Mitsubishi Heavy Industries 三菱重工	SRK35ZSX-WF	-	✓	/	-	-	-	-	/	/	-	-
Bedroom 1 睡房1	Air-conditioning Indoor Unit 空調室內機	Mitsubishi Heavy Industries 三菱重工	SRK25ZSX-WF	/	/	✓	/	/	/	/	/	/	/	/
Bedroom 2 睡房2	Air-conditioning Indoor Unit 空調室內機	Mitsubishi Heavy Industries 三菱重工	SRK25ZSX-WF	/	/	✓	/	/	/	/	/	/	/	/

The Vendor undertakes that if lifts or appliances of the specified brand name or model number are not installed in the Phase, lifts or appliances of comparable quality will be installed.

賣方承諾如期數中沒有安裝指明的品牌名稱或產品型號的升降機或設備，便會安裝品質相若的升降機或設備。

## Notes:

1. The symbol "✓" as shown in the above table denotes "Provided".
2. The symbol "-" as shown in the above table denotes "Not Provided".
3. The symbol "/" as shown in the above table denotes "Not Applicable".
4. 4/F, 13/F, 14/F and 24/F are omitted.

## 備註:

1. 上表 "✓" 代表「提供」。
2. 上表 "-" 代表「不提供」。
3. 上表 "/" 代表「不適用」。
4. 不設4樓、13樓、14樓及24樓。



Appliances Schedule 設備說明表

Location 位置	Appliances 設備	Brand Name 品牌名稱	Model Number 產品型號	Tower 5 (5A) 第5座(5A) Floor and Unit 樓層及單位 3/F 3樓										
				A	B	C	D	E	F	G	M	N	P	Q
Master Bedroom 主人睡房	Air-conditioning Indoor Unit 空調室內機	Mitsubishi Heavy Industries 三菱重工	SRK35ZSX-WF	-	✓	-	✓	✓	/	/	/	/	/	/
	Air-conditioning Indoor Unit 空調室內機	Mitsubishi Heavy Industries 三菱重工	SRK50ZSX-WF	✓	-	-	-	-	/	/	/	/	/	/
	Air-conditioning Indoor Unit 空調室內機	Mitsubishi Heavy Industries 三菱重工	SRK60ZSX-WF	-	-	✓	-	-	/	/	/	/	/	/
Bathroom 浴室	Thermo Ventilator 浴室寶	Panasonic 樂聲牌	FV40BEN4H	✓	✓	✓	✓	✓	✓	✓	✓	✓	✓	✓
	Electric Water Heater 電熱水爐	Stiebel Eltron 斯寶亞創	DHB 21 ST Trend	✓	✓	✓	✓	✓	✓	✓	✓	✓	✓	✓
	Exhaust Fan 抽氣扇	Ostberg	RFE140 AKU	-	✓	✓	✓	✓	✓	✓	✓	✓	✓	✓
Master Bathroom 主人浴室	Thermo Ventilator 浴室寶	Panasonic 樂聲牌	FV40BEN4H	/	/	✓	/	/	/	/	/	/	/	/
	Electric Water Heater 電熱水爐	Stiebel Eltron 斯寶亞創	DHB 21 ST Trend	/	/	✓	/	/	/	/	/	/	/	/
Store Room 2 儲物室 2	Air-conditioning Indoor Unit 空調室內機	Mitsubishi Heavy Industries 三菱重工	SRK20ZSX-WF	✓	/	✓	/	/	/	/	/	/	/	/
Wall-In Closet 衣帽間	Air-conditioning Indoor Unit 空調室內機	Mitsubishi Heavy Industries 三菱重工	SRK25ZSX-WF	/	/	/	/	/	✓	✓	/	/	/	/

The Vendor undertakes that if lifts or appliances of the specified brand name or model number are not installed in the Phase, lifts or appliances of comparable quality will be installed.

賣方承諾如期數中沒有安裝指明的品牌名稱或產品型號的升降機或設備，便會安裝品質相若的升降機或設備。

## Notes:

1. The symbol "✓" as shown in the above table denotes "Provided".
2. The symbol "-" as shown in the above table denotes "Not Provided".
3. The symbol "/" as shown in the above table denotes "Not Applicable".
4. 4/F, 13/F, 14/F and 24/F are omitted.

## 備註:

1. 上表 "✓" 代表「提供」。
2. 上表 "-" 代表「不提供」。
3. 上表 "/" 代表「不適用」。
4. 不設4樓、13樓、14樓及24樓。

Appliances Schedule 設備說明表

Location 位置	Appliances 設備	Brand Name 品牌名稱	Model Number 產品型號	Tower 5 (5A) 第5座(5A) Floor and Unit 樓層及單位 3/F 3樓											
				A	B	C	D	E	F	G	M	N	P	Q	
Flat Roof 平台	Air-conditioning Outdoor Unit 空調室外機	Mitsubishi Heavy Industries 三菱重工	SCM80ZM-S1	✓	-	-	-	-	-	-	-	-	-	✓	✓
	Air-conditioning Outdoor Unit 空調室外機	Mitsubishi Heavy Industries 三菱重工	SCM100ZM-S	✓	-	-	-	-	✓	✓	-	-	-	-	-
	Air-conditioning Outdoor Unit 空調室外機	Mitsubishi Heavy Industries 三菱重工	SCM125ZM-S	-	-	-	✓	✓	-	-	-	-	-	-	-
Inaccessible Common Flat Roof 維修平台	Air-conditioning Outdoor Unit 空調室外機	Mitsubishi Heavy Industries 三菱重工	SRC60ZSXH-S	/	-	-	/	/	/	/	✓	✓	/	/	
	Air-conditioning Outdoor Unit 空調室外機	Mitsubishi Heavy Industries 三菱重工	SCM100ZM-S	/	-	✓	/	/	/	/	-	-	/	/	
	Air-conditioning Outdoor Unit 空調室外機	Mitsubishi Heavy Industries 三菱重工	SCM125ZM-S	/	✓	✓	/	/	/	/	-	-	/	/	

The Vendor undertakes that if lifts or appliances of the specified brand name or model number are not installed in the Phase, lifts or appliances of comparable quality will be installed.

賣方承諾如期數中沒有安裝指明的品牌名稱或產品型號的升降機或設備，便會安裝品質相若的升降機或設備。

## Notes:

1. The symbol "✓" as shown in the above table denotes "Provided".
2. The symbol "-" as shown in the above table denotes "Not Provided".
3. The symbol "/" as shown in the above table denotes "Not Applicable".
4. 4/F, 13/F, 14/F and 24/F are omitted.

## 備註:

1. 上表 "✓" 代表「提供」。
2. 上表 "-" 代表「不提供」。
3. 上表 "/" 代表「不適用」。
4. 不設4樓、13樓、14樓及24樓。

Appliances Schedule 設備說明表

Location 位置	Appliances 設備	Brand Name 品牌名稱	Model Number 產品型號	Tower 5 (5A) 第5座 (5A) Floor and Unit 樓層及單位 5/F 5樓													
				A	B	C	D	E	F	G	J	K	M	N	P	Q	R
Living Room and Dining Room 客廳及飯廳	Video Door Phone 視像對講機	SUPERTECH	ST-C315	✓	✓	✓	✓	✓	✓	✓	✓	✓	✓	✓	✓	✓	✓
	Air-conditioning Indoor Unit 空調室內機	Mitsubishi Heavy Industries 三菱重工	SRK50ZSX-WF	-	-	-	-	-	✓	✓	✓	-	-	-	✓	✓	✓
	Air-conditioning Indoor Unit 空調室內機	Mitsubishi Heavy Industries 三菱重工	SRK60ZSX-WF	✓	✓	✓	✓	✓	-	-	-	✓	✓	✓	-	-	-
	Refrigerator 雪櫃	Whirlpool 惠而浦	ARG8627A	-	-	-	-	-	-	-	-	-	-	-	✓	✓	✓
	Refrigerator 雪櫃	Whirlpool 惠而浦	WHC18T311HK	✓	-	-	✓	-	-	-	-	-	-	-	-	-	-
	7 in 1 Steam Oven with Microwave 7合1微波蒸烤焗爐	Siemens 西門子	CP269AGS0K	-	-	-	-	-	-	-	-	-	-	-	✓	✓	✓
	Washer / Dryer 洗衣 / 乾衣機	Whirlpool 惠而浦	WFCI75430	✓	-	-	-	-	-	-	-	-	-	-	-	-	-
Kitchen or Open Kitchen 廚房或開放式廚房	Gas Hob (1 Burner Gas Hob) 煤氣煮食爐 (單頭)	Siemens 西門子	ER3A6AB70X	✓	✓	✓	✓	✓	-	-	-	-	-	-	-	-	-
	Gas Hob (2 Burners Gas Hob) 煤氣煮食爐 (雙頭)	Siemens 西門子	ER3A6BB70X	✓	✓	✓	✓	✓	✓	✓	✓	-	-	-	✓	✓	✓
	Induction Hob 電磁煮食爐	Siemens 西門子	EX375FXB1E	-	-	-	-	-	-	-	-	✓	✓	✓	-	-	-
	Cooker Hood 抽油煙機	Siemens 西門子	LI67SA531B	-	-	-	-	-	✓	✓	✓	✓	✓	✓	✓	✓	✓
	Cooker Hood 抽油煙機	Siemens 西門子	LI97SA531B	✓	✓	✓	✓	✓	-	-	-	-	-	-	-	-	-

The Vendor undertakes that if lifts or appliances of the specified brand name or model number are not installed in the Phase, lifts or appliances of comparable quality will be installed.

賣方承諾如期數中沒有安裝指明的品牌名稱或產品型號的升降機或設備，便會安裝品質相若的升降機或設備。

## Notes:

1. The symbol "✓" as shown in the above table denotes "Provided".
2. The symbol "-" as shown in the above table denotes "Not Provided".
3. The symbol "/" as shown in the above table denotes "Not Applicable".
4. 4/F, 13/F, 14/F and 24/F are omitted.

## 備註:

1. 上表 "✓" 代表「提供」。
2. 上表 "-" 代表「不提供」。
3. 上表 "/" 代表「不適用」。
4. 不設4樓、13樓、14樓及24樓。

Appliances Schedule 設備說明表

Location 位置	Appliances 設備	Brand Name 品牌名稱	Model Number 產品型號	Tower 5 (5A) 第5座(5A) Floor and Unit 樓層及單位 5/F 5樓													
				A	B	C	D	E	F	G	J	K	M	N	P	Q	R
Kitchen or Open Kitchen 廚房或開放式廚房	Refrigerator 雪櫃	Whirlpool 惠而浦	ARG8627A	-	-	-	-	-	✓	✓	✓	✓	✓	✓	-	-	-
	Refrigerator 雪櫃	Whirlpool 惠而浦	WHC18T311HK	-	✓	✓	-	✓	-	-	-	-	-	-	-	-	-
	7 in 1 Steam Oven with Microwave 7合1微波蒸烤焗爐	Siemens 西門子	CP269AGS0K	✓	✓	-	✓	✓	✓	✓	✓	✓	✓	✓	-	-	-
	Microwave Oven with Grill 微波燒烤爐	Siemens 西門子	BE732L1B1B	-	-	✓	-	-	-	-	-	-	-	-	-	-	-
	Washer / Dryer 洗衣 / 乾衣機	Whirlpool 惠而浦	WFCI75430	-	✓	✓	✓	✓	✓	✓	✓	✓	✓	✓	✓	✓	✓
	Wine Cellar 酒櫃	Vinvautz	VZ07SSUG	-	-	✓	-	-	-	-	-	-	-	-	-	-	-
	Electric Water Heater 電熱水爐	Stiebel Eltron 斯寶亞創	DHM6	✓	✓	✓	✓	✓	✓	✓	✓	✓	✓	✓	✓	✓	✓
	Exhaust Fan 抽氣扇	Ostberg	RFE140 BKU	-	-	✓	-	-	-	-	-	-	-	-	-	-	-
Bedroom 睡房	Air-conditioning Indoor Unit 空調室內機	Mitsubishi Heavy Industries 三菱重工	SRK25ZSX-WF	✓	-	/	✓	✓	✓	✓	✓	/	/	/	✓	✓	✓
	Air-conditioning Indoor Unit 空調室內機	Mitsubishi Heavy Industries 三菱重工	SRK35ZSX-WF	-	✓	/	-	-	-	-	-	/	/	/	-	-	-
Bedroom 1 睡房1	Air-conditioning Indoor Unit 空調室內機	Mitsubishi Heavy Industries 三菱重工	SRK25ZSX-WF	/	/	✓	/	/	/	/	/	/	/	/	/	/	/
Bedroom 2 睡房2	Air-conditioning Indoor Unit 空調室內機	Mitsubishi Heavy Industries 三菱重工	SRK25ZSX-WF	/	/	✓	/	/	/	/	/	/	/	/	/	/	/

The Vendor undertakes that if lifts or appliances of the specified brand name or model number are not installed in the Phase, lifts or appliances of comparable quality will be installed.

賣方承諾如期數中沒有安裝指明的品牌名稱或產品型號的升降機或設備，便會安裝品質相若的升降機或設備。

## Notes:

1. The symbol "✓" as shown in the above table denotes "Provided".
2. The symbol "-" as shown in the above table denotes "Not Provided".
3. The symbol "/" as shown in the above table denotes "Not Applicable".
4. 4/F, 13/F, 14/F and 24/F are omitted.

## 備註:

1. 上表 "✓" 代表「提供」。
2. 上表 "-" 代表「不提供」。
3. 上表 "/" 代表「不適用」。
4. 不設4樓、13樓、14樓及24樓。

Appliances Schedule 設備說明表

Location 位置	Appliances 設備	Brand Name 品牌名稱	Model Number 產品型號	Tower 5 (5A) 第5座(5A) Floor and Unit 樓層及單位 5/F 5樓													
				A	B	C	D	E	F	G	J	K	M	N	P	Q	R
Master Bedroom 主人睡房	Air-conditioning Indoor Unit 空調室內機	Mitsubishi Heavy Industries 三菱重工	SRK35ZSX-WF	-	✓	-	✓	✓	/	/	/	/	/	/	/	/	/
	Air-conditioning Indoor Unit 空調室內機	Mitsubishi Heavy Industries 三菱重工	SRK50ZSX-WF	✓	-	-	-	-	/	/	/	/	/	/	/	/	/
	Air-conditioning Indoor Unit 空調室內機	Mitsubishi Heavy Industries 三菱重工	SRK60ZSX-WF	-	-	✓	-	-	/	/	/	/	/	/	/	/	/
Bathroom 浴室	Thermo Ventilator 浴室寶	Panasonic 樂聲牌	FV40BEN4H	✓	✓	✓	✓	✓	✓	✓	✓	✓	✓	✓	✓	✓	✓
	Electric Water Heater 電熱水爐	Stiebel Eltron 斯寶亞創	DHB 21 ST Trend	✓	✓	✓	✓	✓	✓	✓	✓	✓	✓	✓	✓	✓	✓
	Exhaust Fan 抽氣扇	Ostberg	RFE140 AKU	-	✓	✓	✓	✓	✓	✓	✓	✓	✓	✓	✓	✓	✓
Master Bathroom 主人浴室	Thermo Ventilator 浴室寶	Panasonic 樂聲牌	FV40BEN4H	/	/	✓	/	/	/	/	/	/	/	/	/	/	/
	Electric Water Heater 電熱水爐	Stiebel Eltron 斯寶亞創	DHB 21 ST Trend	/	/	✓	/	/	/	/	/	/	/	/	/	/	/
Store Room 2 儲物室 2	Air-conditioning Indoor Unit 空調室內機	Mitsubishi Heavy Industries 三菱重工	SRK20ZSX-WF	✓	/	✓	/	/	/	/	/	/	/	/	/	/	/
Wall-In Closet 衣帽間	Air-conditioning Indoor Unit 空調室內機	Mitsubishi Heavy Industries 三菱重工	SRK25ZSX-WF	/	/	/	/	/	✓	✓	/	/	/	/	/	/	/

The Vendor undertakes that if lifts or appliances of the specified brand name or model number are not installed in the Phase, lifts or appliances of comparable quality will be installed.

賣方承諾如期數中沒有安裝指明的品牌名稱或產品型號的升降機或設備，便會安裝品質相若的升降機或設備。

## Notes:

1. The symbol "✓" as shown in the above table denotes "Provided".
2. The symbol "-" as shown in the above table denotes "Not Provided".
3. The symbol "/" as shown in the above table denotes "Not Applicable".
4. 4/F, 13/F, 14/F and 24/F are omitted.

## 備註:

1. 上表 "✓" 代表「提供」。
2. 上表 "-" 代表「不提供」。
3. 上表 "/" 代表「不適用」。
4. 不設4樓、13樓、14樓及24樓。

Appliances Schedule 設備說明表

Location 位置	Appliances 設備	Brand Name 品牌名稱	Model Number 產品型號	Tower 5 (5A) 第5座(5A) Floor and Unit 樓層及單位 5/F 5樓														
				A	B	C	D	E	F	G	J	K	M	N	P	Q	R	
Flat Roof 平台	Air-conditioning Outdoor Unit 空調室外機	Mitsubishi Heavy Industries 三菱重工	SRC60ZSXH-S	/	/	/	/	/	/	/	/	-	✓	/	/	/	/	/
	Air-conditioning Outdoor Unit 空調室外機	Mitsubishi Heavy Industries 三菱重工	SCM80ZM-S1	/	/	/	/	/	/	/	/	✓	-	/	/	/	/	/
Air Conditioner Platform 冷氣機平台	Air-conditioning Outdoor Unit 空調室外機	Mitsubishi Heavy Industries 三菱重工	SRC60ZSXH-S	-	-	-	-	-	-	-	-	/	/	✓	✓	-	-	-
	Air-conditioning Outdoor Unit 空調室外機	Mitsubishi Heavy Industries 三菱重工	SCM80ZM-S1	✓	-	-	-	-	-	-	-	/	/	-	-	✓	✓	✓
	Air-conditioning Outdoor Unit 空調室外機	Mitsubishi Heavy Industries 三菱重工	SCM100ZM-S	✓	-	✓	-	-	✓	✓	/	/	-	-	-	-	-	-
	Air-conditioning Outdoor Unit 空調室外機	Mitsubishi Heavy Industries 三菱重工	SCM125ZM-S	-	✓	✓	✓	✓	-	-	/	/	-	-	-	-	-	-

The Vendor undertakes that if lifts or appliances of the specified brand name or model number are not installed in the Phase, lifts or appliances of comparable quality will be installed.

賣方承諾如期數中沒有安裝指明的品牌名稱或產品型號的升降機或設備，便會安裝品質相若的升降機或設備。

## Notes:

1. The symbol "✓" as shown in the above table denotes "Provided".
2. The symbol "-" as shown in the above table denotes "Not Provided".
3. The symbol "/" as shown in the above table denotes "Not Applicable".
4. 4/F, 13/F, 14/F and 24/F are omitted.

## 備註:

1. 上表 "✓" 代表「提供」。
2. 上表 "-" 代表「不提供」。
3. 上表 "/" 代表「不適用」。
4. 不設4樓、13樓、14樓及24樓。

Appliances Schedule 設備說明表

Location 位置	Appliances 設備	Brand Name 品牌名稱	Model Number 產品型號	Tower 5 (5A) 第5座(5A) Floor and Unit 樓層及單位 6/F 6樓														
				A	B	C	D	E	F	G	H	J	K	M	N	P	Q	R
Living Room and Dining Room 客廳及飯廳	Video Door Phone 視像對講機	SUPERTECH	ST-C315	✓	✓	✓	✓	✓	✓	✓	✓	✓	✓	✓	✓	✓	✓	✓
	Air-conditioning Indoor Unit 空調室內機	Mitsubishi Heavy Industries 三菱重工	SRK50ZSX-WF	-	-	-	-	-	✓	✓	✓	✓	-	-	-	✓	✓	✓
	Air-conditioning Indoor Unit 空調室內機	Mitsubishi Heavy Industries 三菱重工	SRK60ZSX-WF	✓	✓	✓	✓	✓	-	-	-	-	✓	✓	✓	-	-	-
	Refrigerator 雪櫃	Whirlpool 惠而浦	ARG8627A	-	-	-	-	-	-	-	-	-	-	-	-	✓	✓	✓
	Refrigerator 雪櫃	Whirlpool 惠而浦	WHC18T311HK	✓	-	-	✓	-	-	-	-	-	-	-	-	-	-	-
	7 in 1 Steam Oven with Microwave 7合1微波蒸烤焗爐	Siemens 西門子	CP269AGS0K	-	-	-	-	-	-	-	-	-	-	-	-	✓	✓	✓
	Washer / Dryer 洗衣 / 乾衣機	Whirlpool 惠而浦	WFCI75430	✓	-	-	-	-	-	-	-	-	-	-	-	-	-	-
Kitchen or Open Kitchen 廚房或開放式廚房	Gas Hob (1 Burner Gas Hob) 煤氣煮食爐(單頭)	Siemens 西門子	ER3A6AB70X	✓	✓	✓	✓	✓	-	-	-	-	-	-	-	-	-	-
	Gas Hob (2 Burners Gas Hob) 煤氣煮食爐(雙頭)	Siemens 西門子	ER3A6BB70X	✓	✓	✓	✓	✓	✓	✓	✓	✓	-	-	-	✓	✓	✓
	Induction Hob 電磁煮食爐	Siemens 西門子	EX375FXB1E	-	-	-	-	-	-	-	-	-	✓	✓	✓	-	-	-
	Cooker Hood 抽油煙機	Siemens 西門子	LI67SA531B	-	-	-	-	-	✓	✓	✓	✓	✓	✓	✓	✓	✓	✓
	Cooker Hood 抽油煙機	Siemens 西門子	LI97SA531B	✓	✓	✓	✓	✓	-	-	-	-	-	-	-	-	-	-

The Vendor undertakes that if lifts or appliances of the specified brand name or model number are not installed in the Phase, lifts or appliances of comparable quality will be installed.

賣方承諾如期數中沒有安裝指明的品牌名稱或產品型號的升降機或設備，便會安裝品質相若的升降機或設備。

## Notes:

1. The symbol "✓" as shown in the above table denotes "Provided".
2. The symbol "-" as shown in the above table denotes "Not Provided".
3. The symbol "/" as shown in the above table denotes "Not Applicable".
4. 4/F, 13/F, 14/F and 24/F are omitted.

## 備註:

1. 上表 "✓" 代表「提供」。
2. 上表 "-" 代表「不提供」。
3. 上表 "/" 代表「不適用」。
4. 不設4樓、13樓、14樓及24樓。

Appliances Schedule 設備說明表

Location 位置	Appliances 設備	Brand Name 品牌名稱	Model Number 產品型號	Tower 5 (5A) 第5座(5A) Floor and Unit 樓層及單位 6/F 6樓														
				A	B	C	D	E	F	G	H	J	K	M	N	P	Q	R
Kitchen or Open Kitchen 廚房或開放式廚房	Refrigerator 雪櫃	Whirlpool 惠而浦	ARG8627A	-	-	-	-	-	✓	✓	✓	✓	✓	✓	✓	-	-	-
	Refrigerator 雪櫃	Whirlpool 惠而浦	WHC18T311HK	-	✓	✓	-	✓	-	-	-	-	-	-	-	-	-	-
	7 in 1 Steam Oven with Microwave 7合1微波蒸烤焗爐	Siemens 西門子	CP269AGS0K	✓	✓	✓	✓	✓	✓	✓	✓	✓	✓	✓	✓	-	-	-
	Microwave Oven with Grill 微波燒烤爐	Siemens 西門子	BE732L1B1B	-	-	✓	-	-	-	-	-	-	-	-	-	-	-	-
	Washer / Dryer 洗衣 / 乾衣機	Whirlpool 惠而浦	WFCI75430	-	✓	✓	✓	✓	✓	✓	✓	✓	✓	✓	✓	✓	✓	✓
	Wine Cellar 酒櫃	Vinvautz	VZ07SSUG	-	-	✓	-	-	-	-	-	-	-	-	-	-	-	-
	Electric Water Heater 電熱水爐	Stiebel Eltron 斯寶亞創	DHM6	✓	✓	✓	✓	✓	✓	✓	✓	✓	✓	✓	✓	✓	✓	✓
	Exhaust Fan 抽氣扇	Ostberg	RFE140 BKU	-	-	✓	-	-	-	-	-	-	-	-	-	-	-	-
Bedroom 睡房	Air-conditioning Indoor Unit 空調室內機	Mitsubishi Heavy Industries 三菱重工	SRK25ZSX-WF	✓	-	/	✓	✓	✓	✓	✓	✓	/	/	/	✓	✓	✓
	Air-conditioning Indoor Unit 空調室內機	Mitsubishi Heavy Industries 三菱重工	SRK35ZSX-WF	-	✓	/	-	-	-	-	-	-	/	/	/	-	-	-
Bedroom 1 睡房1	Air-conditioning Indoor Unit 空調室內機	Mitsubishi Heavy Industries 三菱重工	SRK25ZSX-WF	/	/	✓	/	/	/	/	/	/	/	/	/	/	/	/
Bedroom 2 睡房2	Air-conditioning Indoor Unit 空調室內機	Mitsubishi Heavy Industries 三菱重工	SRK25ZSX-WF	/	/	✓	/	/	/	/	/	/	/	/	/	/	/	/

The Vendor undertakes that if lifts or appliances of the specified brand name or model number are not installed in the Phase, lifts or appliances of comparable quality will be installed.

賣方承諾如期數中沒有安裝指明的品牌名稱或產品型號的升降機或設備，便會安裝品質相若的升降機或設備。

## Notes:

1. The symbol "✓" as shown in the above table denotes "Provided".
2. The symbol "-" as shown in the above table denotes "Not Provided".
3. The symbol "/" as shown in the above table denotes "Not Applicable".
4. 4/F, 13/F, 14/F and 24/F are omitted.

## 備註:

1. 上表 "✓" 代表「提供」。
2. 上表 "-" 代表「不提供」。
3. 上表 "/" 代表「不適用」。
4. 不設4樓、13樓、14樓及24樓。



Appliances Schedule 設備說明表

Location 位置	Appliances 設備	Brand Name 品牌名稱	Model Number 產品型號	Tower 5 (5A) 第5座(5A) Floor and Unit 樓層及單位 6/F 6樓															
				A	B	C	D	E	F	G	H	J	K	M	N	P	Q	R	
Master Bedroom 主人睡房	Air-conditioning Indoor Unit 空調室內機	Mitsubishi Heavy Industries 三菱重工	SRK35ZSX-WF	-	✓	-	✓	✓	/	/	/	/	/	/	/	/	/	/	
	Air-conditioning Indoor Unit 空調室內機	Mitsubishi Heavy Industries 三菱重工	SRK50ZSX-WF	✓	-	-	-	-	/	/	/	/	/	/	/	/	/	/	
	Air-conditioning Indoor Unit 空調室內機	Mitsubishi Heavy Industries 三菱重工	SRK60ZSX-WF	-	-	✓	-	-	/	/	/	/	/	/	/	/	/	/	
Bathroom 浴室	Thermo Ventilator 浴室寶	Panasonic 樂聲牌	FV40BEN4H	✓	✓	✓	✓	✓	✓	✓	✓	✓	✓	✓	✓	✓	✓	✓	
	Electric Water Heater 電熱水爐	Stiebel Eltron 斯寶亞創	DHB 21 ST Trend	✓	✓	✓	✓	✓	✓	✓	✓	✓	✓	✓	✓	✓	✓	✓	
	Exhaust Fan 抽氣扇	Ostberg	RFE140 AKU	-	✓	✓	✓	✓	✓	✓	✓	✓	✓	✓	✓	✓	✓	✓	
Master Bathroom 主人浴室	Thermo Ventilator 浴室寶	Panasonic 樂聲牌	FV40BEN4H	/	/	✓	/	/	/	/	/	/	/	/	/	/	/	/	
	Electric Water Heater 電熱水爐	Stiebel Eltron 斯寶亞創	DHB 21 ST Trend	/	/	✓	/	/	/	/	/	/	/	/	/	/	/	/	
Store Room 2 儲物室 2	Air-conditioning Indoor Unit 空調室內機	Mitsubishi Heavy Industries 三菱重工	SRK20ZSX-WF	✓	/	✓	/	/	/	/	/	/	/	/	/	/	/	/	
Wall-In Closet 衣帽間	Air-conditioning Indoor Unit 空調室內機	Mitsubishi Heavy Industries 三菱重工	SRK25ZSX-WF	/	/	/	/	/	✓	✓	/	/	/	/	/	/	/	/	

The Vendor undertakes that if lifts or appliances of the specified brand name or model number are not installed in the Phase, lifts or appliances of comparable quality will be installed.

賣方承諾如期數中沒有安裝指明的品牌名稱或產品型號的升降機或設備，便會安裝品質相若的升降機或設備。

## Notes:

1. The symbol "✓" as shown in the above table denotes "Provided".
2. The symbol "-" as shown in the above table denotes "Not Provided".
3. The symbol "/" as shown in the above table denotes "Not Applicable".
4. 4/F, 13/F, 14/F and 24/F are omitted.

## 備註:

1. 上表 "✓" 代表「提供」。
2. 上表 "-" 代表「不提供」。
3. 上表 "/" 代表「不適用」。
4. 不設4樓、13樓、14樓及24樓。

Appliances Schedule 設備說明表

Location 位置	Appliances 設備	Brand Name 品牌名稱	Model Number 產品型號	Tower 5 (5A) 第5座(5A) Floor and Unit 樓層及單位 6/F 6樓														
				A	B	C	D	E	F	G	H	J	K	M	N	P	Q	R
Flat Roof 平台	Air-conditioning Outdoor Unit 空調室外機	Mitsubishi Heavy Industries 三菱重工	SCM80ZM-S1	/	/	/	/	/	/	/	/	✓	/	/	/	/	/	/
Air Conditioner Platform 冷氣機平台	Air-conditioning Outdoor Unit 空調室外機	Mitsubishi Heavy Industries 三菱重工	SRC60ZSXH-S	-	-	-	-	-	-	-	-	/	-	✓	✓	✓	-	-
	Air-conditioning Outdoor Unit 空調室外機	Mitsubishi Heavy Industries 三菱重工	SCM80ZM-S1	✓	-	-	-	-	-	-	-	/	✓	-	-	-	✓	✓
	Air-conditioning Outdoor Unit 空調室外機	Mitsubishi Heavy Industries 三菱重工	SCM100ZM-S	✓	-	✓	-	-	✓	✓	/	-	-	-	-	-	-	-
	Air-conditioning Outdoor Unit 空調室外機	Mitsubishi Heavy Industries 三菱重工	SCM125ZM-S	-	✓	✓	✓	✓	-	-	/	-	-	-	-	-	-	-

The Vendor undertakes that if lifts or appliances of the specified brand name or model number are not installed in the Phase, lifts or appliances of comparable quality will be installed.

賣方承諾如期數中沒有安裝指明的品牌名稱或產品型號的升降機或設備，便會安裝品質相若的升降機或設備。

## Notes:

1. The symbol "✓" as shown in the above table denotes "Provided".
2. The symbol "-" as shown in the above table denotes "Not Provided".
3. The symbol "/" as shown in the above table denotes "Not Applicable".
4. 4/F, 13/F, 14/F and 24/F are omitted.

## 備註:

1. 上表 "✓" 代表「提供」。
2. 上表 "-" 代表「不提供」。
3. 上表 "/" 代表「不適用」。
4. 不設4樓、13樓、14樓及24樓。

Appliances Schedule 設備說明表

Location 位置	Appliances 設備	Brand Name 品牌名稱	Model Number 產品型號	Tower 5 (5A) 第5座 (5A) Floor and Unit 樓層及單位 7/F 7樓												
				A	B	C	D	E	F	G	H	J	K	M	N	P
Living Room and Dining Room 客廳及飯廳	Video Door Phone 視像對講機	SUPERTECH	ST-C315	✓	✓	✓	✓	✓	✓	✓	✓	✓	✓	✓	✓	✓
	Air-conditioning Indoor Unit 空調室內機	Mitsubishi Heavy Industries 三菱重工	SRK50ZSX-WF	-	-	-	-	-	✓	✓	✓	✓	-	-	-	✓
	Air-conditioning Indoor Unit 空調室內機	Mitsubishi Heavy Industries 三菱重工	SRK60ZSX-WF	✓	✓	✓	✓	✓	-	-	-	-	✓	✓	✓	-
	Refrigerator 雪櫃	Whirlpool 惠而浦	ARG8627A	-	-	-	-	-	-	-	-	-	-	-	-	✓
	Refrigerator 雪櫃	Whirlpool 惠而浦	WHC18T311HK	✓	-	-	✓	-	-	-	-	-	-	-	-	-
	7 in 1 Steam Oven with Microwave 7合1微波蒸烤焗爐	Siemens 西門子	CP269AGS0K	-	-	-	-	-	-	-	-	-	-	-	-	✓
	Washer / Dryer 洗衣 / 乾衣機	Whirlpool 惠而浦	WFCI75430	✓	-	-	-	-	-	-	-	-	-	-	-	-
Kitchen or Open Kitchen 廚房或開放式廚房	Gas Hob (1 Burner Gas Hob) 煤氣煮食爐 (單頭)	Siemens 西門子	ER3A6AB70X	✓	✓	✓	✓	✓	-	-	-	-	-	-	-	-
	Gas Hob (2 Burners Gas Hob) 煤氣煮食爐 (雙頭)	Siemens 西門子	ER3A6BB70X	✓	✓	✓	✓	✓	✓	✓	✓	✓	-	-	-	✓
	Induction Hob 電磁煮食爐	Siemens 西門子	EX375FXB1E	-	-	-	-	-	-	-	-	-	✓	✓	✓	-
	Cooker Hood 抽油煙機	Siemens 西門子	LI67SA531B	-	-	-	-	-	✓	✓	✓	✓	✓	✓	✓	✓
	Cooker Hood 抽油煙機	Siemens 西門子	LI97SA531B	✓	✓	✓	✓	✓	-	-	-	-	-	-	-	-

The Vendor undertakes that if lifts or appliances of the specified brand name or model number are not installed in the Phase, lifts or appliances of comparable quality will be installed.

賣方承諾如期數中沒有安裝指明的品牌名稱或產品型號的升降機或設備，便會安裝品質相若的升降機或設備。

## Notes:

1. The symbol "✓" as shown in the above table denotes "Provided".
2. The symbol "-" as shown in the above table denotes "Not Provided".
3. The symbol "/" as shown in the above table denotes "Not Applicable".
4. 4/F, 13/F, 14/F and 24/F are omitted.

## 備註:

1. 上表 "✓" 代表「提供」。
2. 上表 "-" 代表「不提供」。
3. 上表 "/" 代表「不適用」。
4. 不設4樓、13樓、14樓及24樓。

Appliances Schedule 設備說明表

Location 位置	Appliances 設備	Brand Name 品牌名稱	Model Number 產品型號	Tower 5 (5A) 第5座(5A) Floor and Unit 樓層及單位 7/F 7樓													
				A	B	C	D	E	F	G	H	J	K	M	N	P	
Kitchen or Open Kitchen 廚房或開放式廚房	Refrigerator 雪櫃	Whirlpool 惠而浦	ARG8627A	-	-	-	-	-	✓	✓	✓	✓	✓	✓	✓	-	
	Refrigerator 雪櫃	Whirlpool 惠而浦	WHC18T311HK	-	✓	✓	-	✓	-	-	-	-	-	-	-	-	
	7 in 1 Steam Oven with Microwave 7合1微波蒸烤焗爐	Siemens 西門子	CP269AGS0K	✓	✓	✓	✓	✓	✓	✓	✓	✓	✓	✓	✓	✓	-
	Microwave Oven with Grill 微波燒烤爐	Siemens 西門子	BE732L1B1B	-	-	✓	-	-	-	-	-	-	-	-	-	-	-
	Washer / Dryer 洗衣 / 乾衣機	Whirlpool 惠而浦	WFCI75430	-	✓	✓	✓	✓	✓	✓	✓	✓	✓	✓	✓	✓	✓
	Wine Cellar 酒櫃	Vinvautz	VZ07SSUG	-	-	✓	-	-	-	-	-	-	-	-	-	-	-
	Electric Water Heater 電熱水爐	Stiebel Eltron 斯寶亞創	DHM6	✓	✓	✓	✓	✓	✓	✓	✓	✓	✓	✓	✓	✓	✓
	Exhaust Fan 抽氣扇	Ostberg	RFE140 BKU	-	-	✓	-	-	-	-	-	-	-	-	-	-	-
Bedroom 睡房	Air-conditioning Indoor Unit 空調室內機	Mitsubishi Heavy Industries 三菱重工	SRK25ZSX-WF	✓	-	/	✓	✓	✓	✓	✓	✓	/	/	/	✓	
	Air-conditioning Indoor Unit 空調室內機	Mitsubishi Heavy Industries 三菱重工	SRK35ZSX-WF	-	✓	/	-	-	-	-	-	-	/	/	/	-	
Bedroom 1 睡房1	Air-conditioning Indoor Unit 空調室內機	Mitsubishi Heavy Industries 三菱重工	SRK25ZSX-WF	/	/	✓	/	/	/	/	/	/	/	/	/	/	
Bedroom 2 睡房2	Air-conditioning Indoor Unit 空調室內機	Mitsubishi Heavy Industries 三菱重工	SRK25ZSX-WF	/	/	✓	/	/	/	/	/	/	/	/	/	/	

The Vendor undertakes that if lifts or appliances of the specified brand name or model number are not installed in the Phase, lifts or appliances of comparable quality will be installed.

賣方承諾如期數中沒有安裝指明的品牌名稱或產品型號的升降機或設備，便會安裝品質相若的升降機或設備。

## Notes:

1. The symbol "✓" as shown in the above table denotes "Provided".
2. The symbol "-" as shown in the above table denotes "Not Provided".
3. The symbol "/" as shown in the above table denotes "Not Applicable".
4. 4/F, 13/F, 14/F and 24/F are omitted.

## 備註:

1. 上表 "✓" 代表「提供」。
2. 上表 "-" 代表「不提供」。
3. 上表 "/" 代表「不適用」。
4. 不設4樓、13樓、14樓及24樓。

Appliances Schedule 設備說明表

Location 位置	Appliances 設備	Brand Name 品牌名稱	Model Number 產品型號	Tower 5 (5A) 第5座(5A) Floor and Unit 樓層及單位 7/F 7樓												
				A	B	C	D	E	F	G	H	J	K	M	N	P
Master Bedroom 主人睡房	Air-conditioning Indoor Unit 空調室內機	Mitsubishi Heavy Industries 三菱重工	SRK35ZSX-WF	-	✓	-	✓	✓	/	/	/	/	/	/	/	/
	Air-conditioning Indoor Unit 空調室內機	Mitsubishi Heavy Industries 三菱重工	SRK50ZSX-WF	✓	-	-	-	-	/	/	/	/	/	/	/	/
	Air-conditioning Indoor Unit 空調室內機	Mitsubishi Heavy Industries 三菱重工	SRK60ZSX-WF	-	-	✓	-	-	/	/	/	/	/	/	/	/
Bathroom 浴室	Thermo Ventilator 浴室寶	Panasonic 樂聲牌	FV40BEN4H	✓	✓	✓	✓	✓	✓	✓	✓	✓	✓	✓	✓	✓
	Electric Water Heater 電熱水爐	Stiebel Eltron 斯寶亞創	DHB 21 ST Trend	✓	✓	✓	✓	✓	✓	✓	✓	✓	✓	✓	✓	✓
	Exhaust Fan 抽氣扇	Ostberg	RFE140 AKU	-	✓	✓	✓	✓	✓	✓	✓	✓	✓	✓	✓	✓
Master Bathroom 主人浴室	Thermo Ventilator 浴室寶	Panasonic 樂聲牌	FV40BEN4H	/	/	✓	/	/	/	/	/	/	/	/	/	/
	Electric Water Heater 電熱水爐	Stiebel Eltron 斯寶亞創	DHB 21 ST Trend	/	/	✓	/	/	/	/	/	/	/	/	/	/
	Exhaust Fan 抽氣扇	Ostberg	RFE140 AKU	/	/	✓	/	/	/	/	/	/	/	/	/	/
Store Room 2 儲物室 2	Air-conditioning Indoor Unit 空調室內機	Mitsubishi Heavy Industries 三菱重工	SRK20ZSX-WF	✓	/	✓	/	/	/	/	/	/	/	/	/	/
Wall-In Closet 衣帽間	Air-conditioning Indoor Unit 空調室內機	Mitsubishi Heavy Industries 三菱重工	SRK25ZSX-WF	/	/	/	/	/	✓	✓	/	/	/	/	/	/

The Vendor undertakes that if lifts or appliances of the specified brand name or model number are not installed in the Phase, lifts or appliances of comparable quality will be installed.

賣方承諾如期數中沒有安裝指明的品牌名稱或產品型號的升降機或設備，便會安裝品質相若的升降機或設備。

## Notes:

1. The symbol "✓" as shown in the above table denotes "Provided".
2. The symbol "-" as shown in the above table denotes "Not Provided".
3. The symbol "/" as shown in the above table denotes "Not Applicable".
4. 4/F, 13/F, 14/F and 24/F are omitted.

## 備註:

1. 上表 "✓" 代表「提供」。
2. 上表 "-" 代表「不提供」。
3. 上表 "/" 代表「不適用」。
4. 不設4樓、13樓、14樓及24樓。

Appliances Schedule 設備說明表

Location 位置	Appliances 設備	Brand Name 品牌名稱	Model Number 產品型號	Tower 5 (5A) 第5座(5A) Floor and Unit 樓層及單位 7/F 7樓												
				A	B	C	D	E	F	G	H	J	K	M	N	P
Air Conditioner Platform 冷氣機平台	Air-conditioning Outdoor Unit 空調室外機	Mitsubishi Heavy Industries 三菱重工	SRC60ZSXH-S	-	-	-	-	-	-	-	-	-	✓	✓	✓	-
	Air-conditioning Outdoor Unit 空調室外機	Mitsubishi Heavy Industries 三菱重工	SCM80ZM-S1	✓	-	-	-	-	-	-	✓	✓	-	-	-	✓
	Air-conditioning Outdoor Unit 空調室外機	Mitsubishi Heavy Industries 三菱重工	SCM100ZM-S	✓	-	✓	-	-	✓	✓	-	-	-	-	-	-
	Air-conditioning Outdoor Unit 空調室外機	Mitsubishi Heavy Industries 三菱重工	SCM125ZM-S	-	✓	✓	✓	✓	-	-	-	-	-	-	-	-

The Vendor undertakes that if lifts or appliances of the specified brand name or model number are not installed in the Phase, lifts or appliances of comparable quality will be installed.  
賣方承諾如期數中沒有安裝指明的品牌名稱或產品型號的升降機或設備，便會安裝品質相若的升降機或設備。

## Notes:

1. The symbol "✓" as shown in the above table denotes "Provided".
2. The symbol "-" as shown in the above table denotes "Not Provided".
3. The symbol "/" as shown in the above table denotes "Not Applicable".
4. 4/F, 13/F, 14/F and 24/F are omitted.

## 備註:

1. 上表 "✓" 代表「提供」。
2. 上表 "-" 代表「不提供」。
3. 上表 "/" 代表「不適用」。
4. 不設4樓、13樓、14樓及24樓。

Appliances Schedule 設備說明表

Location 位置	Appliances 設備	Brand Name 品牌名稱	Model Number 產品型號	Tower 5 (5A) 第5座(5A) Floor and Unit 樓層及單位 8/F 8樓												
				A	B	C	D	E	F	G	H	J	K	M	N	P
Living Room and Dining Room 客廳及飯廳	Video Door Phone 視像對講機	SUPERTECH	ST-C315	✓	✓	✓	✓	✓	✓	✓	✓	✓	✓	✓	✓	✓
	Air-conditioning Indoor Unit 空調室內機	Mitsubishi Heavy Industries 三菱重工	SRK50ZSX-WF	-	-	-	-	-	✓	✓	✓	✓	-	-	-	✓
	Air-conditioning Indoor Unit 空調室內機	Mitsubishi Heavy Industries 三菱重工	SRK60ZSX-WF	✓	✓	✓	✓	✓	-	-	-	-	✓	✓	✓	-
	Refrigerator 雪櫃	Whirlpool 惠而浦	ARG8627A	-	-	-	-	-	-	-	-	-	-	-	-	✓
	Refrigerator 雪櫃	Whirlpool 惠而浦	WHC18T311HK	✓	-	-	✓	-	-	-	-	-	-	-	-	-
	7 in 1 Steam Oven with Microwave 7合1微波蒸烤焗爐	Siemens 西門子	CP269AGS0K	-	-	-	-	-	-	-	-	-	-	-	-	✓
	Washer / Dryer 洗衣 / 乾衣機	Whirlpool 惠而浦	WFCI75430	✓	-	-	-	-	-	-	-	-	-	-	-	-
Kitchen or Open Kitchen 廚房或開放式廚房	Gas Hob (1 Burner Gas Hob) 煤氣煮食爐(單頭)	Siemens 西門子	ER3A6AB70X	✓	✓	✓	✓	✓	-	-	-	-	-	-	-	-
	Gas Hob (2 Burners Gas Hob) 煤氣煮食爐(雙頭)	Siemens 西門子	ER3A6BB70X	✓	✓	✓	✓	✓	✓	✓	✓	✓	-	-	-	✓
	Induction Hob 電磁煮食爐	Siemens 西門子	EX375FXB1E	-	-	-	-	-	-	-	-	-	✓	✓	✓	-
	Cooker Hood 抽油煙機	Siemens 西門子	LI67SA531B	-	-	-	-	-	✓	✓	✓	✓	✓	✓	✓	✓
	Cooker Hood 抽油煙機	Siemens 西門子	LI97SA531B	✓	✓	✓	✓	✓	-	-	-	-	-	-	-	-

The Vendor undertakes that if lifts or appliances of the specified brand name or model number are not installed in the Phase, lifts or appliances of comparable quality will be installed.

賣方承諾如期數中沒有安裝指明的品牌名稱或產品型號的升降機或設備，便會安裝品質相若的升降機或設備。

## Notes:

1. The symbol "✓" as shown in the above table denotes "Provided".
2. The symbol "-" as shown in the above table denotes "Not Provided".
3. The symbol "/" as shown in the above table denotes "Not Applicable".
4. 4/F, 13/F, 14/F and 24/F are omitted.

## 備註:

1. 上表 "✓" 代表「提供」。
2. 上表 "-" 代表「不提供」。
3. 上表 "/" 代表「不適用」。
4. 不設4樓、13樓、14樓及24樓。

Appliances Schedule 設備說明表

Location 位置	Appliances 設備	Brand Name 品牌名稱	Model Number 產品型號	Tower 5 (5A) 第5座(5A) Floor and Unit 樓層及單位 8/F 8樓												
				A	B	C	D	E	F	G	H	J	K	M	N	P
Kitchen or Open Kitchen 廚房或開放式廚房	Refrigerator 雪櫃	Whirlpool 惠而浦	ARG8627A	-	-	-	-	-	✓	✓	✓	✓	✓	✓	✓	-
	Refrigerator 雪櫃	Whirlpool 惠而浦	WHC18T311HK	-	✓	✓	-	✓	-	-	-	-	-	-	-	-
	7 in 1 Steam Oven with Microwave 7合1微波蒸烤焗爐	Siemens 西門子	CP269AGS0K	✓	✓	✓	✓	✓	✓	✓	✓	✓	✓	✓	✓	-
	Microwave Oven with Grill 微波燒烤爐	Siemens 西門子	BE732L1B1B	-	-	✓	-	-	-	-	-	-	-	-	-	-
	Washer / Dryer 洗衣 / 乾衣機	Whirlpool 惠而浦	WFCI75430	-	✓	✓	✓	✓	✓	✓	✓	✓	✓	✓	✓	✓
	Wine Cellar 酒櫃	Vinvautz	VZ07SSUG	-	-	✓	-	-	-	-	-	-	-	-	-	-
	Electric Water Heater 電熱水爐	Stiebel Eltron 斯寶亞創	DHM6	✓	✓	✓	✓	✓	✓	✓	✓	✓	✓	✓	✓	✓
	Exhaust Fan 抽氣扇	Ostberg	RFE140 BKU	-	-	✓	-	-	-	-	-	-	-	-	-	-
Bedroom 睡房	Air-conditioning Indoor Unit 空調室內機	Mitsubishi Heavy Industries 三菱重工	SRK25ZSX-WF	✓	-	/	✓	✓	✓	✓	✓	✓	/	/	/	✓
	Air-conditioning Indoor Unit 空調室內機	Mitsubishi Heavy Industries 三菱重工	SRK35ZSX-WF	-	✓	/	-	-	-	-	-	-	/	/	/	-
Bedroom 1 睡房 1	Air-conditioning Indoor Unit 空調室內機	Mitsubishi Heavy Industries 三菱重工	SRK25ZSX-WF	/	/	✓	/	/	/	/	/	/	/	/	/	/
Bedroom 2 睡房 2	Air-conditioning Indoor Unit 空調室內機	Mitsubishi Heavy Industries 三菱重工	SRK25ZSX-WF	/	/	✓	/	/	/	/	/	/	/	/	/	/

The Vendor undertakes that if lifts or appliances of the specified brand name or model number are not installed in the Phase, lifts or appliances of comparable quality will be installed.

賣方承諾如期數中沒有安裝指明的品牌名稱或產品型號的升降機或設備，便會安裝品質相若的升降機或設備。

## Notes:

1. The symbol "✓" as shown in the above table denotes "Provided".
2. The symbol "-" as shown in the above table denotes "Not Provided".
3. The symbol "/" as shown in the above table denotes "Not Applicable".
4. 4/F, 13/F, 14/F and 24/F are omitted.

## 備註:

1. 上表 "✓" 代表「提供」。
2. 上表 "-" 代表「不提供」。
3. 上表 "/" 代表「不適用」。
4. 不設4樓、13樓、14樓及24樓。



Appliances Schedule 設備說明表

Location 位置	Appliances 設備	Brand Name 品牌名稱	Model Number 產品型號	Tower 5 (5A) 第5座(5A) Floor and Unit 樓層及單位 8/F 8樓												
				A	B	C	D	E	F	G	H	J	K	M	N	P
Master Bedroom 主人睡房	Air-conditioning Indoor Unit 空調室內機	Mitsubishi Heavy Industries 三菱重工	SRK35ZSX-WF	-	✓	-	✓	✓	/	/	/	/	/	/	/	/
	Air-conditioning Indoor Unit 空調室內機	Mitsubishi Heavy Industries 三菱重工	SRK50ZSX-WF	✓	-	-	-	-	/	/	/	/	/	/	/	/
	Air-conditioning Indoor Unit 空調室內機	Mitsubishi Heavy Industries 三菱重工	SRK60ZSX-WF	-	-	✓	-	-	/	/	/	/	/	/	/	/
Bathroom 浴室	Thermo Ventilator 浴室寶	Panasonic 樂聲牌	FV40BEN4H	✓	✓	✓	✓	✓	✓	✓	✓	✓	✓	✓	✓	✓
	Electric Water Heater 電熱水爐	Stiebel Eltron 斯寶亞創	DHB 21 ST Trend	✓	✓	✓	✓	✓	✓	✓	✓	✓	✓	✓	✓	✓
	Exhaust Fan 抽氣扇	Ostberg	RFE140 AKU	-	✓	✓	✓	✓	✓	✓	✓	✓	✓	✓	✓	✓
Master Bathroom 主人浴室	Thermo Ventilator 浴室寶	Panasonic 樂聲牌	FV40BEN4H	/	/	✓	/	/	/	/	/	/	/	/	/	/
	Electric Water Heater 電熱水爐	Stiebel Eltron 斯寶亞創	DHB 21 ST Trend	/	/	✓	/	/	/	/	/	/	/	/	/	/
	Exhaust Fan 抽氣扇	Ostberg	RFE140 AKU	/	/	✓	/	/	/	/	/	/	/	/	/	/
Store Room 2 儲物室 2	Air-conditioning Indoor Unit 空調室內機	Mitsubishi Heavy Industries 三菱重工	SRK20ZSX-WF	✓	/	✓	/	/	/	/	/	/	/	/	/	/
Wall-In Closet 衣帽間	Air-conditioning Indoor Unit 空調室內機	Mitsubishi Heavy Industries 三菱重工	SRK25ZSX-WF	/	/	/	/	/	✓	✓	/	/	/	/	/	/

The Vendor undertakes that if lifts or appliances of the specified brand name or model number are not installed in the Phase, lifts or appliances of comparable quality will be installed.

賣方承諾如期數中沒有安裝指明的品牌名稱或產品型號的升降機或設備，便會安裝品質相若的升降機或設備。

## Notes:

1. The symbol "✓" as shown in the above table denotes "Provided".
2. The symbol "-" as shown in the above table denotes "Not Provided".
3. The symbol "/" as shown in the above table denotes "Not Applicable".
4. 4/F, 13/F, 14/F and 24/F are omitted.

## 備註:

1. 上表 "✓" 代表「提供」。
2. 上表 "-" 代表「不提供」。
3. 上表 "/" 代表「不適用」。
4. 不設4樓、13樓、14樓及24樓。

Appliances Schedule 設備說明表

Location 位置	Appliances 設備	Brand Name 品牌名稱	Model Number 產品型號	Tower 5 (5A) 第5座(5A) Floor and Unit 樓層及單位 8/F 8樓												
				A	B	C	D	E	F	G	H	J	K	M	N	P
Air Conditioner Platform 冷氣機平台	Air-conditioning Outdoor Unit 空調室外機	Mitsubishi Heavy Industries 三菱重工	SRC60ZSXH-S	-	-	-	-	-	-	-	-	-	✓	✓	✓	-
	Air-conditioning Outdoor Unit 空調室外機	Mitsubishi Heavy Industries 三菱重工	SCM80ZM-S1	✓	-	-	-	-	-	-	✓	✓	-	-	-	✓
	Air-conditioning Outdoor Unit 空調室外機	Mitsubishi Heavy Industries 三菱重工	SCM100ZM-S	✓	-	✓	-	-	✓	✓	-	-	-	-	-	-
	Air-conditioning Outdoor Unit 空調室外機	Mitsubishi Heavy Industries 三菱重工	SCM125ZM-S	-	✓	✓	✓	✓	-	-	-	-	-	-	-	-

The Vendor undertakes that if lifts or appliances of the specified brand name or model number are not installed in the Phase, lifts or appliances of comparable quality will be installed.  
賣方承諾如期數中沒有安裝指明的品牌名稱或產品型號的升降機或設備，便會安裝品質相若的升降機或設備。

## Notes:

1. The symbol "✓" as shown in the above table denotes "Provided".
2. The symbol "-" as shown in the above table denotes "Not Provided".
3. The symbol "/" as shown in the above table denotes "Not Applicable".
4. 4/F, 13/F, 14/F and 24/F are omitted.

## 備註:

1. 上表 "✓" 代表「提供」。
2. 上表 "-" 代表「不提供」。
3. 上表 "/" 代表「不適用」。
4. 不設4樓、13樓、14樓及24樓。

Appliances Schedule 設備說明表

Location 位置	Appliances 設備	Brand Name 品牌名稱	Model Number 產品型號	Tower 5 (5A) 第5座 (5A) Floor and Unit 樓層及單位 9/F 9樓													
				A	B	C	D	E	F	G	H	J	K	M	N	P	
Living Room and Dining Room 客廳及飯廳	Video Door Phone 視像對講機	SUPERTECH	ST-C315	✓	✓	✓	✓	✓	✓	✓	✓	✓	✓	✓	✓	✓	
	Air-conditioning Indoor Unit 空調室內機	Mitsubishi Heavy Industries 三菱重工	SRK50ZSX-WF	-	-	-	-	-	✓	✓	✓	✓	-	-	-	✓	
	Air-conditioning Indoor Unit 空調室內機	Mitsubishi Heavy Industries 三菱重工	SRK60ZSX-WF	✓	✓	✓	✓	✓	-	-	-	-	✓	✓	✓	-	
	Refrigerator 雪櫃	Whirlpool 惠而浦	ARG8627A	-	-	-	-	-	-	-	-	-	-	-	-	-	✓
	Refrigerator 雪櫃	Whirlpool 惠而浦	WHC18T311HK	✓	-	-	✓	-	-	-	-	-	-	-	-	-	-
	7 in 1 Steam Oven with Microwave 7合1微波蒸烤焗爐	Siemens 西門子	CP269AGS0K	-	-	-	-	-	-	-	-	-	-	-	-	-	✓
	Washer / Dryer 洗衣 / 乾衣機	Whirlpool 惠而浦	WFCI75430	✓	-	-	-	-	-	-	-	-	-	-	-	-	-
Kitchen or Open Kitchen 廚房或開放式廚房	Gas Hob (1 Burner Gas Hob) 煤氣煮食爐 (單頭)	Siemens 西門子	ER3A6AB70X	✓	✓	✓	✓	✓	-	-	-	-	-	-	-	-	
	Gas Hob (2 Burners Gas Hob) 煤氣煮食爐 (雙頭)	Siemens 西門子	ER3A6BB70X	✓	✓	✓	✓	✓	✓	✓	✓	✓	-	-	-	✓	
	Induction Hob 電磁煮食爐	Siemens 西門子	EX375FXB1E	-	-	-	-	-	-	-	-	-	✓	✓	✓	-	
	Cooker Hood 抽油煙機	Siemens 西門子	LI67SA531B	-	-	-	-	-	✓	✓	✓	✓	✓	✓	✓	✓	
	Cooker Hood 抽油煙機	Siemens 西門子	LI97SA531B	✓	✓	✓	✓	✓	-	-	-	-	-	-	-	-	

The Vendor undertakes that if lifts or appliances of the specified brand name or model number are not installed in the Phase, lifts or appliances of comparable quality will be installed.

賣方承諾如期數中沒有安裝指明的品牌名稱或產品型號的升降機或設備，便會安裝品質相若的升降機或設備。

## Notes:

1. The symbol "✓" as shown in the above table denotes "Provided".
2. The symbol "-" as shown in the above table denotes "Not Provided".
3. The symbol "/" as shown in the above table denotes "Not Applicable".
4. 4/F, 13/F, 14/F and 24/F are omitted.

## 備註:

1. 上表 "✓" 代表「提供」。
2. 上表 "-" 代表「不提供」。
3. 上表 "/" 代表「不適用」。
4. 不設4樓、13樓、14樓及24樓。

Appliances Schedule 設備說明表

Location 位置	Appliances 設備	Brand Name 品牌名稱	Model Number 產品型號	Tower 5 (5A) 第5座(5A) Floor and Unit 樓層及單位 9/F 9樓												
				A	B	C	D	E	F	G	H	J	K	M	N	P
Kitchen or Open Kitchen 廚房或開放式廚房	Refrigerator 雪櫃	Whirlpool 惠而浦	ARG8627A	-	-	-	-	-	✓	✓	✓	✓	✓	✓	✓	-
	Refrigerator 雪櫃	Whirlpool 惠而浦	WHC18T311HK	-	✓	✓	-	✓	-	-	-	-	-	-	-	-
	7 in 1 Steam Oven with Microwave 7合1微波蒸烤焗爐	Siemens 西門子	CP269AGS0K	✓	✓	✓	✓	✓	✓	✓	✓	✓	✓	✓	✓	-
	Microwave Oven with Grill 微波燒烤爐	Siemens 西門子	BE732L1B1B	-	-	✓	-	-	-	-	-	-	-	-	-	-
	Washer / Dryer 洗衣 / 乾衣機	Whirlpool 惠而浦	WFCI75430	-	✓	✓	✓	✓	✓	✓	✓	✓	✓	✓	✓	✓
	Wine Cellar 酒櫃	Vinvautz	VZ07SSUG	-	-	✓	-	-	-	-	-	-	-	-	-	-
	Electric Water Heater 電熱水爐	Stiebel Eltron 斯寶亞創	DHM6	✓	✓	✓	✓	✓	✓	✓	✓	✓	✓	✓	✓	✓
	Exhaust Fan 抽氣扇	Ostberg	RFE140 BKU	-	-	✓	-	-	-	-	-	-	-	-	-	-
Bedroom 睡房	Air-conditioning Indoor Unit 空調室內機	Mitsubishi Heavy Industries 三菱重工	SRK25ZSX-WF	✓	-	/	✓	✓	✓	✓	✓	✓	/	/	/	✓
	Air-conditioning Indoor Unit 空調室內機	Mitsubishi Heavy Industries 三菱重工	SRK35ZSX-WF	-	✓	/	-	-	-	-	-	-	/	/	/	-
Bedroom 1 睡房1	Air-conditioning Indoor Unit 空調室內機	Mitsubishi Heavy Industries 三菱重工	SRK25ZSX-WF	/	/	✓	/	/	/	/	/	/	/	/	/	/
Bedroom 2 睡房2	Air-conditioning Indoor Unit 空調室內機	Mitsubishi Heavy Industries 三菱重工	SRK25ZSX-WF	/	/	✓	/	/	/	/	/	/	/	/	/	/

The Vendor undertakes that if lifts or appliances of the specified brand name or model number are not installed in the Phase, lifts or appliances of comparable quality will be installed.

賣方承諾如期數中沒有安裝指明的品牌名稱或產品型號的升降機或設備，便會安裝品質相若的升降機或設備。

## Notes:

1. The symbol "✓" as shown in the above table denotes "Provided".
2. The symbol "-" as shown in the above table denotes "Not Provided".
3. The symbol "/" as shown in the above table denotes "Not Applicable".
4. 4/F, 13/F, 14/F and 24/F are omitted.

## 備註:

1. 上表 "✓" 代表「提供」。
2. 上表 "-" 代表「不提供」。
3. 上表 "/" 代表「不適用」。
4. 不設4樓、13樓、14樓及24樓。

Appliances Schedule 設備說明表

Location 位置	Appliances 設備	Brand Name 品牌名稱	Model Number 產品型號	Tower 5 (5A) 第5座(5A) Floor and Unit 樓層及單位 9/F 9樓												
				A	B	C	D	E	F	G	H	J	K	M	N	P
Master Bedroom 主人睡房	Air-conditioning Indoor Unit 空調室內機	Mitsubishi Heavy Industries 三菱重工	SRK35ZSX-WF	-	✓	-	✓	✓	/	/	/	/	/	/	/	/
	Air-conditioning Indoor Unit 空調室內機	Mitsubishi Heavy Industries 三菱重工	SRK50ZSX-WF	✓	-	-	-	-	/	/	/	/	/	/	/	/
	Air-conditioning Indoor Unit 空調室內機	Mitsubishi Heavy Industries 三菱重工	SRK60ZSX-WF	-	-	✓	-	-	/	/	/	/	/	/	/	/
Bathroom 浴室	Thermo Ventilator 浴室寶	Panasonic 樂聲牌	FV40BEN4H	✓	✓	✓	✓	✓	✓	✓	✓	✓	✓	✓	✓	✓
	Electric Water Heater 電熱水爐	Stiebel Eltron 斯寶亞創	DHB 21 ST Trend	✓	✓	✓	✓	✓	✓	✓	✓	✓	✓	✓	✓	✓
	Exhaust Fan 抽氣扇	Ostberg	RFE140 AKU	-	✓	✓	✓	✓	✓	✓	✓	✓	✓	✓	✓	✓
Master Bathroom 主人浴室	Thermo Ventilator 浴室寶	Panasonic 樂聲牌	FV40BEN4H	/	/	✓	/	/	/	/	/	/	/	/	/	/
	Electric Water Heater 電熱水爐	Stiebel Eltron 斯寶亞創	DHB 21 ST Trend	/	/	✓	/	/	/	/	/	/	/	/	/	/
	Exhaust Fan 抽氣扇	Ostberg	RFE140 AKU	/	/	✓	/	/	/	/	/	/	/	/	/	/
Store Room 2 儲物室 2	Air-conditioning Indoor Unit 空調室內機	Mitsubishi Heavy Industries 三菱重工	SRK20ZSX-WF	✓	/	✓	/	/	/	/	/	/	/	/	/	/
Wall-In Closet 衣帽間	Air-conditioning Indoor Unit 空調室內機	Mitsubishi Heavy Industries 三菱重工	SRK25ZSX-WF	/	/	/	/	/	✓	✓	/	/	/	/	/	/

The Vendor undertakes that if lifts or appliances of the specified brand name or model number are not installed in the Phase, lifts or appliances of comparable quality will be installed.

賣方承諾如期數中沒有安裝指明的品牌名稱或產品型號的升降機或設備，便會安裝品質相若的升降機或設備。

## Notes:

1. The symbol "✓" as shown in the above table denotes "Provided".
2. The symbol "-" as shown in the above table denotes "Not Provided".
3. The symbol "/" as shown in the above table denotes "Not Applicable".
4. 4/F, 13/F, 14/F and 24/F are omitted.

## 備註:

1. 上表 "✓" 代表「提供」。
2. 上表 "-" 代表「不提供」。
3. 上表 "/" 代表「不適用」。
4. 不設4樓、13樓、14樓及24樓。

Appliances Schedule 設備說明表

Location 位置	Appliances 設備	Brand Name 品牌名稱	Model Number 產品型號	Tower 5 (5A) 第5座(5A) Floor and Unit 樓層及單位 9/F 9樓												
				A	B	C	D	E	F	G	H	J	K	M	N	P
Air Conditioner Platform 冷氣機平台	Air-conditioning Outdoor Unit 空調室外機	Mitsubishi Heavy Industries 三菱重工	SRC60ZSXH-S	-	-	-	-	-	-	-	-	-	✓	✓	✓	-
	Air-conditioning Outdoor Unit 空調室外機	Mitsubishi Heavy Industries 三菱重工	SCM80ZM-S1	✓	-	-	-	-	-	-	✓	✓	-	-	-	✓
	Air-conditioning Outdoor Unit 空調室外機	Mitsubishi Heavy Industries 三菱重工	SCM100ZM-S	✓	-	✓	-	-	✓	✓	-	-	-	-	-	-
	Air-conditioning Outdoor Unit 空調室外機	Mitsubishi Heavy Industries 三菱重工	SCM125ZM-S	-	✓	✓	✓	✓	-	-	-	-	-	-	-	-

The Vendor undertakes that if lifts or appliances of the specified brand name or model number are not installed in the Phase, lifts or appliances of comparable quality will be installed.  
賣方承諾如期數中沒有安裝指明的品牌名稱或產品型號的升降機或設備，便會安裝品質相若的升降機或設備。

## Notes:

1. The symbol "✓" as shown in the above table denotes "Provided".
2. The symbol "-" as shown in the above table denotes "Not Provided".
3. The symbol "/" as shown in the above table denotes "Not Applicable".
4. 4/F, 13/F, 14/F and 24/F are omitted.

## 備註:

1. 上表 "✓" 代表「提供」。
2. 上表 "-" 代表「不提供」。
3. 上表 "/" 代表「不適用」。
4. 不設4樓、13樓、14樓及24樓。

Appliances Schedule 設備說明表

Location 位置	Appliances 設備	Brand Name 品牌名稱	Model Number 產品型號	Tower 5 (5A) 第5座(5A) Floor and Unit 樓層及單位 10/F - 12/F, 15/F - 23/F & 25/F - 26/F 10樓至12樓、15樓至23樓及25樓至26樓													
				A	B	C	D	E	F	G	H	J	K	M	N	P	
Living Room and Dining Room 客廳及飯廳	Video Door Phone 視像對講機	SUPERTECH	ST-C315	✓	✓	✓	✓	✓	✓	✓	✓	✓	✓	✓	✓	✓	
	Air-conditioning Indoor Unit 空調室內機	Mitsubishi Heavy Industries 三菱重工	SRK50ZSX-WF	-	-	-	-	-	✓	✓	✓	✓	-	-	-	✓	
	Air-conditioning Indoor Unit 空調室內機	Mitsubishi Heavy Industries 三菱重工	SRK60ZSX-WF	✓	✓	✓	✓	✓	-	-	-	-	✓	✓	✓	-	
	Refrigerator 雪櫃	Whirlpool 惠而浦	ARG8627A	-	-	-	-	-	-	-	-	-	-	-	-	-	✓
	Refrigerator 雪櫃	Whirlpool 惠而浦	WHC18T311HK	✓	-	-	✓	-	-	-	-	-	-	-	-	-	-
	7 in 1 Steam Oven with Microwave 7合1微波蒸烤焗爐	Siemens 西門子	CP269AGS0K	-	-	-	-	-	-	-	-	-	-	-	-	-	✓
	Washer / Dryer 洗衣 / 乾衣機	Whirlpool 惠而浦	WFCI75430	✓	-	-	-	-	-	-	-	-	-	-	-	-	-
Kitchen or Open Kitchen 廚房或開放式廚房	Gas Hob (1 Burner Gas Hob) 煤氣煮食爐(單頭)	Siemens 西門子	ER3A6AB70X	✓	✓	✓	✓	✓	-	-	-	-	-	-	-	-	
	Gas Hob (2 Burners Gas Hob) 煤氣煮食爐(雙頭)	Siemens 西門子	ER3A6BB70X	✓	✓	✓	✓	✓	✓	✓	✓	✓	-	-	-	✓	
	Induction Hob 電磁煮食爐	Siemens 西門子	EX375FXB1E	-	-	-	-	-	-	-	-	-	✓	✓	✓	-	
	Cooker Hood 抽油煙機	Siemens 西門子	LI67SA531B	-	-	-	-	-	✓	✓	✓	✓	✓	✓	✓	✓	
	Cooker Hood 抽油煙機	Siemens 西門子	LI97SA531B	✓	✓	✓	✓	✓	-	-	-	-	-	-	-	-	

The Vendor undertakes that if lifts or appliances of the specified brand name or model number are not installed in the Phase, lifts or appliances of comparable quality will be installed.

賣方承諾如期數中沒有安裝指明的品牌名稱或產品型號的升降機或設備，便會安裝品質相若的升降機或設備。

## Notes:

1. The symbol "✓" as shown in the above table denotes "Provided".
2. The symbol "-" as shown in the above table denotes "Not Provided".
3. The symbol "/" as shown in the above table denotes "Not Applicable".
4. 4/F, 13/F, 14/F and 24/F are omitted.

## 備註:

1. 上表 "✓" 代表「提供」。
2. 上表 "-" 代表「不提供」。
3. 上表 "/" 代表「不適用」。
4. 不設4樓、13樓、14樓及24樓。

Appliances Schedule 設備說明表

Location 位置	Appliances 設備	Brand Name 品牌名稱	Model Number 產品型號	Tower 5 (5A) 第5座(5A) Floor and Unit 樓層及單位 10/F - 12/F, 15/F - 23/F & 25/F - 26/F 10樓至12樓、15樓至23樓及25樓至26樓													
				A	B	C	D	E	F	G	H	J	K	M	N	P	
Kitchen or Open Kitchen 廚房或開放式廚房	Refrigerator 雪櫃	Whirlpool 惠而浦	ARG8627A	-	-	-	-	-	✓	✓	✓	✓	✓	✓	✓	-	
	Refrigerator 雪櫃	Whirlpool 惠而浦	WHC18T311HK	-	✓	✓	-	✓	-	-	-	-	-	-	-	-	
	7 in 1 Steam Oven with Microwave 7合1微波蒸烤焗爐	Siemens 西門子	CP269AGS0K	✓	✓	✓	✓	✓	✓	✓	✓	✓	✓	✓	✓	✓	-
	Microwave Oven with Grill 微波燒烤爐	Siemens 西門子	BE732L1B1B	-	-	✓	-	-	-	-	-	-	-	-	-	-	-
	Washer / Dryer 洗衣 / 乾衣機	Whirlpool 惠而浦	WFCI75430	-	✓	✓	✓	✓	✓	✓	✓	✓	✓	✓	✓	✓	✓
	Wine Cellar 酒櫃	Vinvautz	VZ07SSUG	-	-	✓	-	-	-	-	-	-	-	-	-	-	-
	Electric Water Heater 電熱水爐	Stiebel Eltron 斯寶亞創	DHM6	✓	✓	✓	✓	✓	✓	✓	✓	✓	✓	✓	✓	✓	✓
	Exhaust Fan 抽氣扇	Ostberg	RFE140 BKU	-	-	✓	-	-	-	-	-	-	-	-	-	-	-
Bedroom 睡房	Air-conditioning Indoor Unit 空調室內機	Mitsubishi Heavy Industries 三菱重工	SRK25ZSX-WF	✓	-	/	✓	✓	✓	✓	✓	✓	/	/	/	✓	
	Air-conditioning Indoor Unit 空調室內機	Mitsubishi Heavy Industries 三菱重工	SRK35ZSX-WF	-	✓	/	-	-	-	-	-	-	/	/	/	-	
Bedroom 1 睡房1	Air-conditioning Indoor Unit 空調室內機	Mitsubishi Heavy Industries 三菱重工	SRK25ZSX-WF	/	/	✓	/	/	/	/	/	/	/	/	/	/	
Bedroom 2 睡房2	Air-conditioning Indoor Unit 空調室內機	Mitsubishi Heavy Industries 三菱重工	SRK25ZSX-WF	/	/	✓	/	/	/	/	/	/	/	/	/	/	

The Vendor undertakes that if lifts or appliances of the specified brand name or model number are not installed in the Phase, lifts or appliances of comparable quality will be installed.

賣方承諾如期數中沒有安裝指明的品牌名稱或產品型號的升降機或設備，便會安裝品質相若的升降機或設備。

## Notes:

1. The symbol "✓" as shown in the above table denotes "Provided".
2. The symbol "-" as shown in the above table denotes "Not Provided".
3. The symbol "/" as shown in the above table denotes "Not Applicable".
4. 4/F, 13/F, 14/F and 24/F are omitted.

## 備註:

1. 上表 "✓" 代表「提供」。
2. 上表 "-" 代表「不提供」。
3. 上表 "/" 代表「不適用」。
4. 不設4樓、13樓、14樓及24樓。



Appliances Schedule 設備說明表

Location 位置	Appliances 設備	Brand Name 品牌名稱	Model Number 產品型號	Tower 5 (5A) 第5座(5A) Floor and Unit 樓層及單位 10/F - 12/F, 15/F - 23/F & 25/F - 26/F 10樓至12樓、15樓至23樓及25樓至26樓												
				A	B	C	D	E	F	G	H	J	K	M	N	P
Master Bedroom 主人睡房	Air-conditioning Indoor Unit 空調室內機	Mitsubishi Heavy Industries 三菱重工	SRK35ZSX-WF	-	✓	-	✓	✓	/	/	/	/	/	/	/	/
	Air-conditioning Indoor Unit 空調室內機	Mitsubishi Heavy Industries 三菱重工	SRK50ZSX-WF	✓	-	-	-	-	/	/	/	/	/	/	/	/
	Air-conditioning Indoor Unit 空調室內機	Mitsubishi Heavy Industries 三菱重工	SRK60ZSX-WF	-	-	✓	-	-	/	/	/	/	/	/	/	/
Bathroom 浴室	Thermo Ventilator 浴室寶	Panasonic 樂聲牌	FV40BEN4H	✓	✓	✓	✓	✓	✓	✓	✓	✓	✓	✓	✓	✓
	Electric Water Heater 電熱水爐	Stiebel Eltron 斯寶亞創	DHB 21 ST Trend	✓	✓	✓	✓	✓	✓	✓	✓	✓	✓	✓	✓	✓
	Exhaust Fan 抽氣扇	Ostberg	RFE140 AKU	-	✓	✓	✓	✓	✓	✓	✓	✓	✓	✓	✓	✓
Master Bathroom 主人浴室	Thermo Ventilator 浴室寶	Panasonic 樂聲牌	FV40BEN4H	/	/	✓	/	/	/	/	/	/	/	/	/	/
	Electric Water Heater 電熱水爐	Stiebel Eltron 斯寶亞創	DHB 21 ST Trend	/	/	✓	/	/	/	/	/	/	/	/	/	/
	Exhaust Fan 抽氣扇	Ostberg	RFE140 AKU	/	/	✓	/	/	/	/	/	/	/	/	/	/
Store Room 2 儲物室 2	Air-conditioning Indoor Unit 空調室內機	Mitsubishi Heavy Industries 三菱重工	SRK20ZSX-WF	✓	/	✓	/	/	/	/	/	/	/	/	/	/
Wall-In Closet 衣帽間	Air-conditioning Indoor Unit 空調室內機	Mitsubishi Heavy Industries 三菱重工	SRK25ZSX-WF	/	/	/	/	/	✓	✓	/	/	/	/	/	/

The Vendor undertakes that if lifts or appliances of the specified brand name or model number are not installed in the Phase, lifts or appliances of comparable quality will be installed.

賣方承諾如期數中沒有安裝指明的品牌名稱或產品型號的升降機或設備，便會安裝品質相若的升降機或設備。

## Notes:

1. The symbol "✓" as shown in the above table denotes "Provided".
2. The symbol "-" as shown in the above table denotes "Not Provided".
3. The symbol "/" as shown in the above table denotes "Not Applicable".
4. 4/F, 13/F, 14/F and 24/F are omitted.

## 備註:

1. 上表 "✓" 代表「提供」。
2. 上表 "-" 代表「不提供」。
3. 上表 "/" 代表「不適用」。
4. 不設4樓、13樓、14樓及24樓。

Appliances Schedule 設備說明表

Location 位置	Appliances 設備	Brand Name 品牌名稱	Model Number 產品型號	Tower 5 (5A) 第5座(5A) Floor and Unit 樓層及單位 10/F - 12/F, 15/F - 23/F & 25/F - 26/F 10樓至12樓、15樓至23樓及25樓至26樓												
				A	B	C	D	E	F	G	H	J	K	M	N	P
Air Conditioner Platform 冷氣機平台	Air-conditioning Outdoor Unit 空調室外機	Mitsubishi Heavy Industries 三菱重工	SRC60ZSXH-S	-	-	-	-	-	-	-	-	-	✓	✓	✓	-
	Air-conditioning Outdoor Unit 空調室外機	Mitsubishi Heavy Industries 三菱重工	SCM80ZM-S1	✓	-	-	-	-	-	-	✓	✓	-	-	-	✓
	Air-conditioning Outdoor Unit 空調室外機	Mitsubishi Heavy Industries 三菱重工	SCM100ZM-S	✓	-	✓	-	-	✓	✓	-	-	-	-	-	-
	Air-conditioning Outdoor Unit 空調室外機	Mitsubishi Heavy Industries 三菱重工	SCM125ZM-S	-	✓	✓	✓	✓	-	-	-	-	-	-	-	-

The Vendor undertakes that if lifts or appliances of the specified brand name or model number are not installed in the Phase, lifts or appliances of comparable quality will be installed.  
賣方承諾如期數中沒有安裝指明的品牌名稱或產品型號的升降機或設備，便會安裝品質相若的升降機或設備。

## Notes:

1. The symbol "✓" as shown in the above table denotes "Provided".
2. The symbol "-" as shown in the above table denotes "Not Provided".
3. The symbol "/" as shown in the above table denotes "Not Applicable".
4. 4/F, 13/F, 14/F and 24/F are omitted.

## 備註:

1. 上表"✓"代表「提供」。
2. 上表"-"代表「不提供」。
3. 上表"/"代表「不適用」。
4. 不設4樓、13樓、14樓及24樓。

Appliances Schedule 設備說明表

Location 位置	Appliances 設備	Brand Name 品牌名稱	Model Number 產品型號	Tower 5 (5B) 第5座(5B) Floor and Unit 樓層及單位 7/F 7樓						
				A	B	C	J	K	M	N
Living Room and Dining Room 客廳及飯廳	Video Door Phone 視像對講機	SUPERTECH	ST-C315	✓	✓	✓	✓	✓	✓	✓
	Air-conditioning Indoor Unit 空調室內機	Mitsubishi Heavy Industries 三菱重工	SRK50ZSX-WF	✓	✓	-	-	-	✓	✓
	Air-conditioning Indoor Unit 空調室內機	Mitsubishi Heavy Industries 三菱重工	SRK60ZSX-WF	-	-	✓	✓	✓	-	-
	Refrigerator 雪櫃	Whirlpool 惠而浦	ARG8627A	✓	✓	-	-	-	-	-
	7 in 1 Steam Oven with Microwave 7合1微波蒸烤焗爐	Siemens 西門子	CP269AGS0K	✓	✓	-	-	-	-	-
Kitchen or Open Kitchen 廚房或開放式廚房	Gas Hob (2 Burners Gas Hob) 煤氣煮食爐(雙頭)	Siemens 西門子	ER3A6BB70X	✓	✓	-	-	-	✓	✓
	Induction Hob 電磁煮食爐	Siemens 西門子	EX375FXB1E	-	-	✓	✓	✓	-	-
	Cooker Hood 抽油煙機	Siemens 西門子	LI67SA531B	✓	✓	✓	✓	✓	✓	✓
	Refrigerator 雪櫃	Whirlpool 惠而浦	ARG8627A	-	-	✓	✓	✓	✓	✓
	Built-In Steam Oven with Microwave 7合1微波蒸烤焗爐	Siemens 西門子	CP269AGS0K	-	-	✓	✓	✓	✓	✓
	Washer / Dryer 洗衣 / 乾衣機	Whirlpool 惠而浦	WFCI75430	✓	✓	✓	✓	✓	✓	✓
	Electric Water Heater 電熱水爐	Stiebel Eltron 斯寶亞創	DHM6	✓	✓	✓	✓	✓	✓	✓

The Vendor undertakes that if lifts or appliances of the specified brand name or model number are not installed in the Phase, lifts or appliances of comparable quality will be installed.

賣方承諾如期數中沒有安裝指明的品牌名稱或產品型號的升降機或設備，便會安裝品質相若的升降機或設備。

## Notes:

1. The symbol "✓" as shown in the above table denotes "Provided".
2. The symbol "-" as shown in the above table denotes "Not Provided".
3. The symbol "/" as shown in the above table denotes "Not Applicable".
4. 4/F, 13/F, 14/F and 24/F are omitted.

## 備註:

1. 上表 "✓" 代表「提供」。
2. 上表 "-" 代表「不提供」。
3. 上表 "/" 代表「不適用」。
4. 不設4樓、13樓、14樓及24樓。

Appliances Schedule 設備說明表

Location 位置	Appliances 設備	Brand Name 品牌名稱	Model Number 產品型號	Tower 5 (5B) 第5座(5B) Floor and Unit 樓層及單位 7/F 7樓						
				A	B	C	J	K	M	N
Bedroom 睡房	Air-conditioning Indoor Unit 空調室內機	Mitsubishi Heavy Industries 三菱重工	SRK25ZSX-WF	✓	✓	/	/	/	✓	✓
Bathroom 浴室	Thermo Ventilator 浴室寶	Panasonic 樂聲牌	FV40BEN4H	✓	✓	✓	✓	✓	✓	✓
	Electric Water Heater 電熱水爐	Stiebel Eltron 斯寶亞創	DHB 21 ST Trend	✓	✓	✓	✓	✓	✓	✓
	Exhaust Fan 抽氣扇	Ostberg	RFE140 AKU	✓	✓	✓	✓	✓	✓	✓
Air Conditioner Platform 冷氣機平台	Air-conditioning Outdoor Unit 空調室外機	Mitsubishi Heavy Industries 三菱重工	SRC60ZSXH-S	-	-	✓	/	/	-	/
	Air-conditioning Outdoor Unit 空調室外機	Mitsubishi Heavy Industries 三菱重工	SCM80ZM-S1	✓	✓	-	/	/	✓	/
Flat Roof 平台	Air-conditioning Outdoor Unit 空調室外機	Mitsubishi Heavy Industries 三菱重工	SRC60ZSXH-S	/	/	/	✓	✓	/	/
			SCM80ZM-S1	/	/	/	/	/	/	✓

The Vendor undertakes that if lifts or appliances of the specified brand name or model number are not installed in the Phase, lifts or appliances of comparable quality will be installed.

賣方承諾如期數中沒有安裝指明的品牌名稱或產品型號的升降機或設備，便會安裝品質相若的升降機或設備。

## Notes:

1. The symbol "✓" as shown in the above table denotes "Provided".
2. The symbol "-" as shown in the above table denotes "Not Provided".
3. The symbol "/" as shown in the above table denotes "Not Applicable".
4. 4/F, 13/F, 14/F and 24/F are omitted.

## 備註:

1. 上表 "✓" 代表「提供」。
2. 上表 "-" 代表「不提供」。
3. 上表 "/" 代表「不適用」。
4. 不設4樓、13樓、14樓及24樓。

Appliances Schedule 設備說明表

Location 位置	Appliances 設備	Brand Name 品牌名稱	Model Number 產品型號	Tower 5 (5B) 第5座(5B) Floor and Unit 樓層及單位 8/F 8樓						
				A	B	C	J	K	M	N
Living Room and Dining Room 客廳及飯廳	Video Door Phone 視像對講機	SUPERTECH	ST-C315	✓	✓	✓	✓	✓	✓	✓
	Air-conditioning Indoor Unit 空調室內機	Mitsubishi Heavy Industries 三菱重工	SRK50ZSX-WF	✓	✓	-	-	-	✓	✓
	Air-conditioning Indoor Unit 空調室內機	Mitsubishi Heavy Industries 三菱重工	SRK60ZSX-WF	-	-	✓	✓	✓	-	-
	Refrigerator 雪櫃	Whirlpool 惠而浦	ARG8627A	✓	✓	-	-	-	-	-
	7 in 1 Steam Oven with Microwave 7合1微波蒸烤焗爐	Siemens 西門子	CP269AGS0K	✓	✓	-	-	-	-	-
Kitchen or Open Kitchen 廚房或開放式廚房	Gas Hob (2 Burners Gas Hob) 煤氣煮食爐(雙頭)	Siemens 西門子	ER3A6BB70X	✓	✓	-	-	-	✓	✓
	Induction Hob 電磁煮食爐	Siemens 西門子	EX375FXB1E	-	-	✓	✓	✓	-	-
	Cooker Hood 抽油煙機	Siemens 西門子	LI67SA531B	✓	✓	✓	✓	✓	✓	✓
	Refrigerator 雪櫃	Whirlpool 惠而浦	ARG8627A	-	-	✓	✓	✓	✓	✓
	Built-In Steam Oven with Microwave 7合1微波蒸烤焗爐	Siemens 西門子	CP269AGS0K	-	-	✓	✓	✓	✓	✓
	Washer / Dryer 洗衣 / 乾衣機	Whirlpool 惠而浦	WFCI75430	✓	✓	✓	✓	✓	✓	✓
	Electric Water Heater 電熱水爐	Stiebel Eltron 斯寶亞創	DHM6	✓	✓	✓	✓	✓	✓	✓

The Vendor undertakes that if lifts or appliances of the specified brand name or model number are not installed in the Phase, lifts or appliances of comparable quality will be installed.

賣方承諾如期數中沒有安裝指明的品牌名稱或產品型號的升降機或設備，便會安裝品質相若的升降機或設備。

## Notes:

1. The symbol "✓" as shown in the above table denotes "Provided".
2. The symbol "-" as shown in the above table denotes "Not Provided".
3. The symbol "/" as shown in the above table denotes "Not Applicable".
4. 4/F, 13/F, 14/F and 24/F are omitted.

## 備註:

1. 上表 "✓" 代表「提供」。
2. 上表 "-" 代表「不提供」。
3. 上表 "/" 代表「不適用」。
4. 不設4樓、13樓、14樓及24樓。

Appliances Schedule 設備說明表

Location 位置	Appliances 設備	Brand Name 品牌名稱	Model Number 產品型號	Tower 5 (5B) 第5座(5B) Floor and Unit 樓層及單位 8/F 8樓						
				A	B	C	J	K	M	N
Bedroom 睡房	Air-conditioning Indoor Unit 空調室內機	Mitsubishi Heavy Industries 三菱重工	SRK25ZSX-WF	✓	✓	/	/	/	✓	✓
Bathroom 浴室	Thermo Ventilator 浴室寶	Panasonic 樂聲牌	FV40BEN4H	✓	✓	✓	✓	✓	✓	✓
	Electric Water Heater 電熱水爐	Stiebel Eltron 斯寶亞創	DHB 21 ST Trend	✓	✓	✓	✓	✓	✓	✓
	Exhaust Fan 抽氣扇	Ostberg	RFE140 AKU	✓	✓	✓	✓	✓	✓	✓
Air Conditioner Platform 冷氣機平台	Air-conditioning Outdoor Unit 空調室外機	Mitsubishi Heavy Industries 三菱重工	SRC60ZSXH-S	-	-	✓	✓	✓	-	-
	Air-conditioning Outdoor Unit 空調室外機	Mitsubishi Heavy Industries 三菱重工	SCM80ZM-S1	✓	✓	-	-	-	✓	✓

The Vendor undertakes that if lifts or appliances of the specified brand name or model number are not installed in the Phase, lifts or appliances of comparable quality will be installed.

賣方承諾如期數中沒有安裝指明的品牌名稱或產品型號的升降機或設備，便會安裝品質相若的升降機或設備。

## Notes:

1. The symbol "✓" as shown in the above table denotes "Provided".
2. The symbol "-" as shown in the above table denotes "Not Provided".
3. The symbol "/" as shown in the above table denotes "Not Applicable".
4. 4/F, 13/F, 14/F and 24/F are omitted.

## 備註：

1. 上表“✓”代表「提供」。
2. 上表“-”代表「不提供」。
3. 上表“/”代表「不適用」。
4. 不設4樓、13樓、14樓及24樓。

Appliances Schedule 設備說明表

Location 位置	Appliances 設備	Brand Name 品牌名稱	Model Number 產品型號	Tower 5 (5B) 第5座(5B) Floor and Unit 樓層及單位 9/F 9樓											
				A	B	C	D	E	F	G	H	J	K	M	N
Living Room and Dining Room 客廳及飯廳	Video Door Phone 視像對講機	SUPERTECH	ST-C315	✓	✓	✓	✓	✓	✓	✓	✓	✓	✓	✓	✓
	Air-conditioning Indoor Unit 空調室內機	Mitsubishi Heavy Industries 三菱重工	SRK35ZSX-WF	-	-	-	-	-	-	-	✓	-	-	-	-
	Air-conditioning Indoor Unit 空調室內機	Mitsubishi Heavy Industries 三菱重工	SRK50ZSX-WF	✓	✓	-	-	-	✓	✓	✓	-	-	-	✓
	Air-conditioning Indoor Unit 空調室內機	Mitsubishi Heavy Industries 三菱重工	SRK60ZSX-WF	-	-	✓	✓	✓	✓	✓	-	✓	✓	✓	-
	Refrigerator 雪櫃	Whirlpool 惠而浦	ARG8627A	✓	✓	-	-	-	✓	✓	-	-	-	-	-
	7 in 1 Steam Oven with Microwave 7合1微波蒸烤焗爐	Siemens 西門子	CP269AGS0K	✓	✓	-	-	-	✓	✓	-	-	-	-	-
Kitchen or Open Kitchen 廚房或開放式廚房	Gas Hob (2 Burners Gas Hob) 煤氣煮食爐(雙頭)	Siemens 西門子	ER3A6BB70X	✓	✓	-	-	-	✓	✓	-	-	-	✓	✓
	Induction Hob 電磁煮食爐	Siemens 西門子	EX375FXB1E	-	-	✓	✓	✓	-	-	✓	✓	✓	-	-
	Cooker Hood 抽油煙機	Siemens 西門子	LI67SA531B	✓	✓	✓	✓	✓	✓	✓	✓	✓	✓	✓	✓
	Refrigerator 雪櫃	Whirlpool 惠而浦	ARG8627A	-	-	✓	✓	✓	-	✓	✓	✓	✓	✓	✓
	Built-In Steam Oven with Microwave 7合1微波蒸烤焗爐	Siemens 西門子	CP269AGS0K	-	-	✓	✓	✓	-	✓	✓	✓	✓	✓	✓

The Vendor undertakes that if lifts or appliances of the specified brand name or model number are not installed in the Phase, lifts or appliances of comparable quality will be installed.

賣方承諾如期數中沒有安裝指明的品牌名稱或產品型號的升降機或設備，便會安裝品質相若的升降機或設備。

## Notes:

1. The symbol "✓" as shown in the above table denotes "Provided".
2. The symbol "-" as shown in the above table denotes "Not Provided".
3. The symbol "/" as shown in the above table denotes "Not Applicable".
4. 4/F, 13/F, 14/F and 24/F are omitted.

## 備註:

1. 上表 "✓" 代表「提供」。
2. 上表 "-" 代表「不提供」。
3. 上表 "/" 代表「不適用」。
4. 不設4樓、13樓、14樓及24樓。

Appliances Schedule 設備說明表

Location 位置	Appliances 設備	Brand Name 品牌名稱	Model Number 產品型號	Tower 5 (5B) 第5座(5B) Floor and Unit 樓層及單位 9/F 9樓											
				A	B	C	D	E	F	G	H	J	K	M	N
Kitchen or Open Kitchen 廚房或開放式廚房	Washer / Dryer 洗衣 / 乾衣機	Whirlpool 惠而浦	WFCI75430	✓	✓	✓	✓	✓	✓	✓	✓	✓	✓	✓	✓
	Electric Water Heater 電熱水爐	Stiebel Eltron 斯寶亞創	DHM6	✓	✓	✓	✓	✓	✓	✓	✓	✓	✓	✓	✓
Bedroom 睡房	Air-conditioning Indoor Unit 空調室內機	Mitsubishi Heavy Industries 三菱重工	SRK25ZSX-WF	✓	✓	/	/	/	/	/	/	/	/	✓	✓
Bathroom 浴室	Thermo Ventilator 浴室寶	Panasonic 樂聲牌	FV40BEN4H	✓	✓	✓	✓	✓	✓	✓	✓	✓	✓	✓	✓
	Electric Water Heater 電熱水爐	Stiebel Eltron 斯寶亞創	DHB 21 ST Trend	✓	✓	✓	✓	✓	✓	✓	✓	✓	✓	✓	✓
	Exhaust Fan 抽氣扇	Ostberg	RFE140 AKU	✓	✓	✓	✓	✓	-	✓	✓	✓	✓	✓	✓
Flat Roof 平台	Air-conditioning Outdoor Unit 空調室外機	Mitsubishi Heavy Industries 三菱重工	SCM100ZM-S	/	/	/	-	-	-	✓	-	/	/	/	/
Inaccessible Common Flat Roof 維修平台	Air-conditioning Outdoor Unit 空調室外機	Mitsubishi Heavy Industries 三菱重工	SRC60ZSXH-S	/	/	/	✓	✓	/	/	✓	/	/	/	/
Air Conditioner Platform 冷氣機平台	Air-conditioning Outdoor Unit 空調室外機	Mitsubishi Heavy Industries 三菱重工	SRC60ZSXH-S	-	-	✓	/	/	-	/	/	✓	✓	-	-
	Air-conditioning Outdoor Unit 空調室外機	Mitsubishi Heavy Industries 三菱重工	SCM80ZM-S1	✓	✓	-	/	/	-	/	/	-	-	✓	✓
	Air-conditioning Outdoor Unit 空調室外機	Mitsubishi Heavy Industries 三菱重工	SCM125ZM-S	-	-	-	/	/	✓	/	/	-	-	-	-

The Vendor undertakes that if lifts or appliances of the specified brand name or model number are not installed in the Phase, lifts or appliances of comparable quality will be installed.

賣方承諾如期數中沒有安裝指明的品牌名稱或產品型號的升降機或設備，便會安裝品質相若的升降機或設備。

## Notes:

1. The symbol "✓" as shown in the above table denotes "Provided".
2. The symbol "-" as shown in the above table denotes "Not Provided".
3. The symbol "/" as shown in the above table denotes "Not Applicable".
4. 4/F, 13/F, 14/F and 24/F are omitted.

## 備註:

1. 上表 "✓" 代表「提供」。
2. 上表 "-" 代表「不提供」。
3. 上表 "/" 代表「不適用」。
4. 不設4樓、13樓、14樓及24樓。



Appliances Schedule 設備說明表

Location 位置	Appliances 設備	Brand Name 品牌名稱	Model Number 產品型號	Tower 5 (5B) 第5座(5B) Floor and Unit 樓層及單位 10/F - 12/F, 15/F - 23/F & 25/F - 26/F 10樓至12樓、15樓至23樓及25樓至26樓											
				A	B	C	D	E	F	G	H	J	K	M	N
Living Room and Dining Room 客廳及飯廳	Video Door Phone 視像對講機	SUPERTECH	ST-C315	✓	✓	✓	✓	✓	✓	✓	✓	✓	✓	✓	✓
	Air-conditioning Indoor Unit 空調室內機	Mitsubishi Heavy Industries 三菱重工	SRK35ZSX-WF	-	-	-	-	-	-	✓	-	-	-	-	-
	Air-conditioning Indoor Unit 空調室內機	Mitsubishi Heavy Industries 三菱重工	SRK50ZSX-WF	✓	✓	-	-	-	✓	✓	-	-	-	✓	✓
	Air-conditioning Indoor Unit 空調室內機	Mitsubishi Heavy Industries 三菱重工	SRK60ZSX-WF	-	-	✓	✓	✓	✓	-	✓	✓	✓	-	-
	Refrigerator 雪櫃	Whirlpool 惠而浦	ARG8627A	✓	✓	-	-	-	✓	-	-	-	-	-	-
	7 in 1 Steam Oven with Microwave 7合1微波蒸烤焗爐	Siemens 西門子	CP269AGS0K	✓	✓	-	-	-	✓	-	-	-	-	-	-
Kitchen or Open Kitchen 廚房或開放式廚房	Gas Hob (2 Burners Gas Hob) 煤氣煮食爐(雙頭)	Siemens 西門子	ER3A6BB70X	✓	✓	-	-	-	✓	✓	-	-	-	✓	✓
	Induction Hob 電磁煮食爐	Siemens 西門子	EX375FXB1E	-	-	✓	✓	✓	-	-	✓	✓	✓	-	-
	Cooker Hood 抽油煙機	Siemens 西門子	LI67SA531B	✓	✓	✓	✓	✓	✓	✓	✓	✓	✓	✓	✓
	Refrigerator 雪櫃	Whirlpool 惠而浦	ARG8627A	-	-	✓	✓	✓	-	✓	✓	✓	✓	✓	✓
	Built-In Steam Oven with Microwave 7合1微波蒸烤焗爐	Siemens 西門子	CP269AGS0K	-	-	✓	✓	✓	-	✓	✓	✓	✓	✓	✓

The Vendor undertakes that if lifts or appliances of the specified brand name or model number are not installed in the Phase, lifts or appliances of comparable quality will be installed.

賣方承諾如期數中沒有安裝指明的品牌名稱或產品型號的升降機或設備，便會安裝品質相若的升降機或設備。

## Notes:

1. The symbol "✓" as shown in the above table denotes "Provided".
2. The symbol "-" as shown in the above table denotes "Not Provided".
3. The symbol "/" as shown in the above table denotes "Not Applicable".
4. 4/F, 13/F, 14/F and 24/F are omitted.

## 備註:

1. 上表 "✓" 代表「提供」。
2. 上表 "-" 代表「不提供」。
3. 上表 "/" 代表「不適用」。
4. 不設4樓、13樓、14樓及24樓。

Appliances Schedule 設備說明表

Location 位置	Appliances 設備	Brand Name 品牌名稱	Model Number 產品型號	Tower 5 (5B) 第5座(5B) Floor and Unit 樓層及單位 10/F - 12/F, 15/F - 23/F & 25/F - 26/F 10樓至12樓、15樓至23樓及25樓至26樓											
				A	B	C	D	E	F	G	H	J	K	M	N
Kitchen or Open Kitchen 廚房或開放式廚房	Washer / Dryer 洗衣 / 乾衣機	Whirlpool 惠而浦	WFCI75430	✓	✓	✓	✓	✓	✓	✓	✓	✓	✓	✓	✓
	Electric Water Heater 電熱水爐	Stiebel Eltron 斯寶亞創	DHM6	✓	✓	✓	✓	✓	✓	✓	✓	✓	✓	✓	✓
Bedroom 睡房	Air-conditioning Indoor Unit 空調室內機	Mitsubishi Heavy Industries 三菱重工	SRK25ZSX-WF	✓	✓	/	/	/	/	/	/	/	/	✓	✓
Bathroom 浴室	Thermo Ventilator 浴室寶	Panasonic 樂聲牌	FV40BEN4H	✓	✓	✓	✓	✓	✓	✓	✓	✓	✓	✓	✓
	Electric Water Heater 電熱水爐	Stiebel Eltron 斯寶亞創	DHB 21 ST Trend	✓	✓	✓	✓	✓	✓	✓	✓	✓	✓	✓	✓
	Exhaust Fan 抽氣扇	Ostberg	RFE140 AKU	✓	✓	✓	✓	✓	-	✓	✓	✓	✓	✓	✓
Air Conditioner Platform 冷氣機平台	Air-conditioning Outdoor Unit 空調室外機	Mitsubishi Heavy Industries 三菱重工	SRC60ZSXH-S	-	-	✓	✓	✓	-	-	✓	✓	✓	-	-
	Air-conditioning Outdoor Unit 空調室外機	Mitsubishi Heavy Industries 三菱重工	SCM80ZM-S1	✓	✓	-	-	-	-	-	-	-	-	✓	✓
	Air-conditioning Outdoor Unit 空調室外機	Mitsubishi Heavy Industries 三菱重工	SCM100ZM-S	-	-	-	-	-	-	✓	-	-	-	-	-
	Air-conditioning Outdoor Unit 空調室外機	Mitsubishi Heavy Industries 三菱重工	SCM125ZM-S	-	-	-	-	-	✓	-	-	-	-	-	-

The Vendor undertakes that if lifts or appliances of the specified brand name or model number are not installed in the Phase, lifts or appliances of comparable quality will be installed.

賣方承諾如期數中沒有安裝指明的品牌名稱或產品型號的升降機或設備，便會安裝品質相若的升降機或設備。

## Notes:

1. The symbol "✓" as shown in the above table denotes "Provided".
2. The symbol "-" as shown in the above table denotes "Not Provided".
3. The symbol "/" as shown in the above table denotes "Not Applicable".
4. 4/F, 13/F, 14/F and 24/F are omitted.

## 備註:

1. 上表 "✓" 代表「提供」。
2. 上表 "-" 代表「不提供」。
3. 上表 "/" 代表「不適用」。
4. 不設4樓、13樓、14樓及24樓。

Schedule of Electrical &amp; Mechanical Provisions of Residential Units 住宅單位機電裝置數量說明表

Location 位置	Appliances 設備	Tower 3 第3座 Floor and Unit 樓層及單位 3/F 3樓										Tower 3 第3座 Floor and Unit 樓層及單位 5/F 5樓										
		B	C	D	E	F	G	H	J	K	A	B	C	D	E	F	G	H	J	K	M	N
Main Entrance 大門入口	Door Bell Button 門鈴按鈕	1	1	1	1	1	1	1	1	1	1	1	1	1	1	1	1	1	1	1	1	
Living Room and Dining Room 客廳及飯廳	Lighting Point 燈位	3	3	3	3	3	4	3	3	3	5	3	3	3	3	4	3	3	3	3	3	
	Lighting Switch 燈掣	4	4	4	4	4	4	4	4	4	5	4	4	4	4	4	4	4	4	4	4	4
	13A Single Socket Outlet 13安培單位電插座	1	-	1	1	1	1	-	1	1	1	1	-	1	1	1	-	1	1	1	1	
	13A Twin Socket Outlet 13安培雙位電插座	2	2	2	2	2	2	1	1	1	2	2	2	2	2	2	2	1	1	1	1	1
	Telephone Outlet 電話插座	1	1	1	1	1	1	1	1	1	2	1	1	1	1	1	1	1	1	1	1	1
	TV/FM Outlet 電視 / 電台天線插座	1	1	1	1	1	1	2	2	2	2	1	1	1	1	1	1	2	2	2	2	2
	Incoming Data Box With Blank Cover 總數據插座連蓋板	1	1	1	1	1	1	1	1	1	1	1	1	1	1	1	1	1	1	1	1	1
	Standby Data Box With Blank Cover 後備數據盒連蓋板	-	-	-	-	-	-	1	1	1	1	-	-	-	-	-	-	1	1	1	1	1
	Switch for Air-conditioner Indoor Unit 冷氣機室內機開關掣	1	1	1	1	1	1	2	2	2	1	1	1	1	1	1	1	2	2	2	2	2
	Video Door Phone 視像對講機	1	1	1	1	1	1	1	1	1	1	1	1	1	1	1	1	1	1	1	1	1
	13A Single Socket Outlet With USB 13安培單位電插座連 USB	1	1	1	1	1	1	1	1	1	1	1	1	1	1	1	1	1	1	1	1	1
	13A Twin Socket Outlet With USB 13安培雙位電插座連 USB	-	-	-	-	-	-	1	1	1	1	-	-	-	-	-	-	1	1	1	1	1
	Miniature Circuit Breakers Board 總電掣箱	1	-	1	-	1	1	1	1	1	1	1	-	1	-	1	1	1	1	1	1	1
	Door Bell With Connection Unit 門鈴連接線位	1	1	1	1	1	1	1	1	1	1	1	1	1	1	1	1	1	1	1	1	1
	Switch with Connection Unit for Steam Oven with Microwave 微波蒸烤焗爐開關掣連接線位	-	-	-	-	-	-	-	1	1	-	-	-	-	-	-	-	-	1	1	1	1
	Switch with Connection Unit for Exhaust Fan 抽氣扇開關掣連接線位	-	-	-	-	-	-	-	-	-	1	-	-	-	-	-	-	-	-	-	-	-
Double Pole Switch 雙極開關掣	3	3	3	3	3	3	3	3	3	4	3	3	3	3	3	3	3	3	3	3	3	
Smoke Detector 煙霧探測器	1	1	1	1	1	1	1	1	1	-	1	1	1	1	1	1	1	1	1	1	1	

## Notes:

- “1, 2, ……” as shown in the above table denotes the quantity of such provision(s) provided in the residential property.
- The symbol “-” as shown in the above table denotes “Not Provided”.
- The symbol “/” as shown in the above table denotes “Not Applicable”.
- 4/F, 13/F, 14/F and 24/F are omitted.

## 備註:

- 上表「1, 2, ……」表示提供於該住宅物業內的裝置數量。
- 上表“-”代表「不提供」。
- 上表“/”代表「不適用」。
- 不設4樓、13樓、14樓及24樓。

Schedule of Electrical &amp; Mechanical Provisions of Residential Units 住宅單位機電裝置數量說明表

Location 位置	Appliances 設備	Tower 3 第3座 Floor and Unit 樓層及單位 3/F 3樓										Tower 3 第3座 Floor and Unit 樓層及單位 5/F 5樓									
		B	C	D	E	F	G	H	J	K	A	B	C	D	E	F	G	H	J	K	M
Kitchen or Open Kitchen 廚房或開放式廚房	Lighting Point 燈位	-	-	-	-	-	-	-	-	-	3	-	-	-	-	-	-	-	-	-	-
	13A Single Socket Outlet 13安培單位電插座	2	3	2	2	2	3	4	3	3	6	2	3	2	2	2	3	4	3	3	3
	13A Twin Socket Outlet 13安培雙位電插座	1	1	1	1	1	1	-	-	-	1	1	1	1	1	1	-	-	-	-	-
	Connection Unit for Electric Water Heater 電熱水爐接線位	1	1	1	1	1	1	1	1	1	1	1	1	1	1	1	1	1	1	1	1
	Switch with Connection Unit for Exhaust Fan 抽氣扇開關掣連接線位	-	-	-	-	-	-	-	-	-	1	-	-	-	-	-	-	-	-	-	-
	13A Twin Socket Outlet With USB 13安培雙位電插座連 USB	1	1	1	1	1	1	1	1	1	1	1	1	1	1	1	1	1	1	1	1
	Switch with Connection Unit for Steam Oven with Microwave 微波蒸烤焗爐開關掣連接線位	1	1	1	1	1	1	1	-	-	1	1	1	1	1	1	1	1	-	-	-
	Towngas Connection Point 煤氣接駁點	1	1	1	1	1	1	1	1	1	1	1	1	1	1	1	1	1	1	1	1
	Washing Machine Water Supply 洗衣機來水位	1	1	1	1	1	1	1	1	1	1	1	1	1	1	1	1	1	1	1	1
	Washing Machine Drain 洗衣機去水位	1	1	1	1	1	1	1	1	1	1	1	1	1	1	1	1	1	1	1	1
	Fire Service Sprinkler Head 消防花灑頭	3	3	3	3	3	3	3	2	2	-	3	3	3	3	3	3	3	2	2	2
Miniature Circuit Breakers Board 總電掣箱	-	1	-	1	-	-	-	-	-	-	-	1	-	1	-	-	-	-	-	-	
Bathroom 浴室	Lighting Point 燈位	3	3	3	3	3	3	3	3	3	3	3	3	3	3	3	3	3	3	3	
	Switch with Connection Unit for Exhaust Fan 抽氣扇開關掣連接線位	1	1	1	1	1	-	-	1	1	-	1	1	1	1	-	-	1	1	1	
	Switch with Connection Unit for Thermo Ventilator 浴室寶開關掣連接線位	1	1	1	1	1	1	1	1	1	1	1	1	1	1	1	1	1	1	1	
	32A TPN Weatherproof Switch with Connection Unit for Electric Water Heater 防水32A 三相電熱水爐開關掣連接線位	1	1	1	1	1	1	1	1	1	1	1	1	1	1	1	1	1	1	1	
Store Room 2 儲物室2	13A Twin Socket Outlet With USB 13安培雙位電插座連 USB	1	1	1	1	1	1	1	1	1	1	1	1	1	1	1	1	1	1	1	
	Lighting Point 燈位	/	/	/	/	/	1	/	/	/	/	/	/	/	/	1	/	/	/	/	
	Lighting Switch 燈掣	/	/	/	/	/	1	/	/	/	/	/	/	/	/	1	/	/	/	/	
Switch for Air-conditioner Indoor Unit 冷氣機室內機開關掣	/	/	/	/	/	1	/	/	/	/	/	/	/	/	1	/	/	/	/		

## Notes:

- "1, 2, ....." as shown in the above table denotes the quantity of such provision(s) provided in the residential property.
- The symbol "-" as shown in the above table denotes "Not Provided".
- The symbol "/" as shown in the above table denotes "Not Applicable".
- 4/F, 13/F, 14/F and 24/F are omitted.

## 備註:

- 上表「1, 2, ....."表示提供於該住宅物業內的裝置數量。
- 上表“-”代表「不提供」。
- 上表“/”代表「不適用」。
- 不設4樓、13樓、14樓及24樓。

Schedule of Electrical &amp; Mechanical Provisions of Residential Units 住宅單位機電裝置數量說明表

Location 位置	Appliances 設備	Tower 3 第3座 Floor and Unit 樓層及單位 3/F 3樓									Tower 3 第3座 Floor and Unit 樓層及單位 5/F 5樓											
		B	C	D	E	F	G	H	J	K	A	B	C	D	E	F	G	H	J	K	M	N
Bedroom or Bedroom 1 睡房或睡房 1	Lighting Point 燈位	1	1	1	1	1	1	/	/	/	1	1	1	1	1	1	1	/	/	/	/	/
	Lighting Switch 燈掣	1	1	1	1	1	1	/	/	/	1	1	1	1	1	1	1	/	/	/	/	/
	13A Single Socket Outlet 13安培單位電插座	1	1	1	1	1	1	/	/	/	1	1	1	1	1	1	1	/	/	/	/	/
	TV / FM Outlet 電視 / 電台天線插座	1	1	1	1	1	1	/	/	/	1	1	1	1	1	1	1	/	/	/	/	/
	Standby Data Box With Blank Cover 後備數據盒連蓋板	1	1	1	1	1	1	/	/	/	1	1	1	1	1	1	1	/	/	/	/	/
	Switch for Air-conditioner Indoor Unit 冷氣機室內機開關掣	1	1	1	1	1	1	/	/	/	1	1	1	1	1	1	1	/	/	/	/	/
	13A Twin Socket Outlet With USB 13安培雙位電插座連 USB	1	1	1	1	1	1	/	/	/	1	1	1	1	1	1	1	/	/	/	/	/
Bedroom 2 睡房 2	Lighting Point 燈位	/	/	/	/	/	/	/	/	/	1	/	/	/	/	/	/	/	/	/	/	/
	Lighting Switch 燈掣	/	/	/	/	/	/	/	/	/	1	/	/	/	/	/	/	/	/	/	/	/
	13A Single Socket Outlet 13安培單位電插座	/	/	/	/	/	/	/	/	/	1	/	/	/	/	/	/	/	/	/	/	/
	TV / FM Outlet 電視 / 電台天線插座	/	/	/	/	/	/	/	/	/	1	/	/	/	/	/	/	/	/	/	/	/
	Standby Data Box With Blank Cover 後備數據盒連蓋板	/	/	/	/	/	/	/	/	/	1	/	/	/	/	/	/	/	/	/	/	/
	Switch for Air-conditioner Indoor Unit 冷氣機室內機開關掣	/	/	/	/	/	/	/	/	/	1	/	/	/	/	/	/	/	/	/	/	/
	13A Twin Socket Outlet With USB 13安培雙位電插座連 USB	/	/	/	/	/	/	/	/	/	1	/	/	/	/	/	/	/	/	/	/	/
Master Bedroom 主人睡房	Lighting Point 燈位	2	1	2	1	1	1	/	/	/	1	2	1	2	1	1	1	/	/	/	/	/
	Lighting Switch 燈掣	1	1	1	1	1	1	/	/	/	3	1	1	1	1	1	1	/	/	/	/	/
	13A Single Socket Outlet 13安培單位電插座	1	1	1	1	1	1	/	/	/	1	1	1	1	1	1	1	/	/	/	/	/
	TV / FM Outlet 電視 / 電台天線插座	1	1	1	1	1	1	/	/	/	1	1	1	1	1	1	1	/	/	/	/	/
	Standby Data Box With Blank Cover 後備數據盒連蓋板	1	1	1	1	1	1	/	/	/	1	1	1	1	1	1	1	/	/	/	/	/
	Switch for Air-conditioner Indoor Unit 冷氣機室內機開關掣	1	1	1	1	1	1	/	/	/	1	1	1	1	1	1	1	/	/	/	/	/
	13A Twin Socket Outlet With USB 13安培雙位電插座連 USB	1	1	1	1	1	1	/	/	/	1	1	1	1	1	1	1	/	/	/	/	/
	Switch with Connection Unit for Exhaust Fan 抽氣扇開關掣連接線位	-	-	-	-	-	-	/	/	/	1	-	-	-	-	-	-	/	/	/	/	/
	Double Pole Switch 雙極開關掣	-	-	-	-	-	-	-	-	-	2	-	-	-	-	-	-	-	-	-	-	-

## Notes:

- "1, 2, ....." as shown in the above table denotes the quantity of such provision(s) provided in the residential property.
- The symbol "-" as shown in the above table denotes "Not Provided".
- The symbol "/" as shown in the above table denotes "Not Applicable".
- 4/F, 13/F, 14/F and 24/F are omitted.

## 備註:

- 上表「1, 2, .....
- 上表“-”代表「不提供」。
- 上表“/”代表「不適用」。
- 不設4樓、13樓、14樓及24樓。

Schedule of Electrical &amp; Mechanical Provisions of Residential Units 住宅單位機電裝置數量說明表

Location 位置	Appliances 設備	Tower 3 第3座 Floor and Unit 樓層及單位 3/F 3樓									Tower 3 第3座 Floor and Unit 樓層及單位 5/F 5樓										
		B	C	D	E	F	G	H	J	K	A	B	C	D	E	F	G	H	J	K	M
Master Bathroom 主人浴室	Connection Unit for Thermo Ventilator 浴室竇接線位	/	/	/	/	/	/	/	/	/	1	/	/	/	/	/	/	/	/	/	/
	32A TPN Weatherproof Switch with Connection Unit for Electric Water Heater 防水32A 三相電熱水爐開關掣連接線位	/	/	/	/	/	/	/	/	/	1	/	/	/	/	/	/	/	/	/	/
	13A Twin Socket Outlet With USB 13安培雙位電插座連 USB	/	/	/	/	/	/	/	/	/	1	/	/	/	/	/	/	/	/	/	/
	Lighting Point 燈位	/	/	/	/	/	/	/	/	/	3	/	/	/	/	/	/	/	/	/	/
Balcony and Utility Room 露台及工作平台	Lighting Point 燈位	/	/	/	/	/	/	/	/	/	1	1	1	1	1	1	1	1	1	1	
	Gas Meter 煤氣錶	/	/	/	/	/	/	/	/	/	1	1	1	1	1	1	1	1	1	1	
Air-conditioner Platform 冷氣機平台	Switch for Air-conditioner Outdoor Unit 冷氣機室外機開關掣	/	/	/	/	/	/	/	/	/	1	1	1	1	1	1	1	1	1	1	
Flat Roof 平台	Lighting Point 燈位	3	3	3	3	3	2	2	2	3	6	/	/	/	/	/	/	/	/	1	3
	13A Waterproof Single Socket Outlet 13安培單位防水電插座	1	1	1	1	1	1	1	1	1	2	/	/	/	/	/	/	/	/	1	1
	Switch for Air-conditioner Outdoor Unit 冷氣機室外機開關掣	1	1	-	1	1	1	-	-	-	2	/	/	/	/	/	/	/	/	-	-
	Gas Meter 煤氣錶	1	1	1	1	1	1	1	1	1	1	/	/	/	/	/	/	/	/	-	-
Common Planter 公用花槽	Switch for Air-conditioner Outdoor Unit 冷氣機室外機開關掣	/	/	/	/	/	/	/	/	1	/	/	/	/	/	/	/	/	/	/	
Inaccessible Common Flat Roof 維修平台	Switch for Air-conditioner Outdoor Unit 冷氣機室外機開關掣	/	/	1	/	/	/	1	1	/	/	/	/	/	/	/	/	/	/	/	

## Notes:

- "1, 2, ....." as shown in the above table denotes the quantity of such provision(s) provided in the residential property.
- The symbol "-" as shown in the above table denotes "Not Provided".
- The symbol "/" as shown in the above table denotes "Not Applicable".
- 4/F, 13/F, 14/F and 24/F are omitted.

## 備註:

- 上表「1, 2, .....
- 上表“-”代表「不提供」。
- 上表“/”代表「不適用」。
- 不設4樓、13樓、14樓及24樓。

Schedule of Electrical &amp; Mechanical Provisions of Residential Units 住宅單位機電裝置數量說明表

Location 位置	Appliances 設備	Tower 3 第3座 Floor and Unit 樓層及單位 6/F - 12/F, 15/F - 23/F & 25/F 6樓至12樓、15樓至23樓及25樓												Tower 3 第3座 Floor and Unit 樓層及單位 26/F 26樓											
		A	B	C	D	E	F	G	H	J	K	M	N	A	B	C	D	E	F	G	H	J	K	M	N
Main Entrance 大門入口	Door Bell Button 門鈴按鈕	1	1	1	1	1	1	1	1	1	1	1	1	1	1	1	1	1	1	1	1	1	1		
Living Room and Dining Room 客廳及飯廳	Lighting Point 燈位	5	3	3	3	3	3	4	3	3	3	3	3	5	3	3	3	3	3	4	3	3	3	3	
	Lighting Switch 燈掣	5	4	4	4	4	4	4	4	4	4	4	4	5	4	4	4	4	4	4	4	4	4	4	
	13A Single Socket Outlet 13安培單位電插座	1	1	-	1	1	1	1	-	1	1	1	1	1	1	-	1	1	1	-	1	1	1	1	
	13A Twin Socket Outlet 13安培雙位電插座	2	2	2	2	2	2	2	1	1	1	1	1	2	2	2	2	2	2	1	1	1	1	1	
	Telephone Outlet 電話插座	2	1	1	1	1	1	1	1	1	1	1	1	2	1	1	1	1	1	1	1	1	1	1	
	TV/FM Outlet 電視 / 電台天線插座	2	1	1	1	1	1	1	2	2	2	2	2	2	1	1	1	1	1	1	2	2	2	2	
	Incoming Data Box With Blank Cover 總數據插座連蓋板	1	1	1	1	1	1	1	1	1	1	1	1	1	1	1	1	1	1	1	1	1	1	1	
	Standby Data Box With Blank Cover 後備數據盒連蓋板	1	-	-	-	-	-	-	1	1	1	1	1	1	-	-	-	-	-	-	1	1	1	1	
	Switch for Air-conditioner Indoor Unit 冷氣機室內機開關掣	1	1	1	1	1	1	1	2	2	2	2	2	1	1	1	1	1	1	2	2	2	2	2	
	Video Door Phone 視像對講機	1	1	1	1	1	1	1	1	1	1	1	1	1	1	1	1	1	1	1	1	1	1	1	
	13A Single Socket Outlet With USB 13安培單位電插座連 USB	1	1	1	1	1	1	1	1	1	1	1	1	1	1	1	1	1	1	1	1	1	1	1	
	13A Twin Socket Outlet With USB 13安培雙位電插座連 USB	1	-	-	-	-	-	-	1	1	1	1	1	1	-	-	-	-	-	-	1	1	1	1	
	Miniature Circuit Breakers Board 總電掣箱	1	1	-	1	-	1	1	1	1	1	1	1	1	1	-	1	-	1	1	1	1	1	1	
	Door Bell With Connection Unit 門鈴連接線位	1	1	1	1	1	1	1	1	1	1	1	1	1	1	1	1	1	1	1	1	1	1	1	
	Switch with Connection Unit for Steam Oven with Microwave 微波蒸烤焗爐開關掣連接線位	-	-	-	-	-	-	-	-	1	1	1	1	-	-	-	-	-	-	-	-	1	1	1	
	Switch with Connection Unit for Exhaust Fan 抽氣扇開關掣連接線位	1	-	-	-	-	-	-	-	-	-	-	-	1	-	-	-	-	-	-	-	-	-	-	
Double Pole Switch 雙極開關掣	4	3	3	3	3	3	3	3	3	3	3	3	4	3	3	3	3	3	3	3	3	3	3		
Smoke Detector 煙霧探測器	-	1	1	1	1	1	1	1	1	1	1	1	-	1	1	1	1	1	1	1	1	1	1		

## Notes:

- "1, 2, ....." as shown in the above table denotes the quantity of such provision(s) provided in the residential property.
- The symbol "-" as shown in the above table denotes "Not Provided".
- The symbol "/" as shown in the above table denotes "Not Applicable".
- 4/F, 13/F, 14/F and 24/F are omitted.

## 備註:

- 上表「1, 2, .....
- 上表“-”代表「不提供」。
- 上表“/”代表「不適用」。
- 不設4樓、13樓、14樓及24樓。

Schedule of Electrical &amp; Mechanical Provisions of Residential Units 住宅單位機電裝置數量說明表

Location 位置	Appliances 設備	Tower 3 第3座 Floor and Unit 樓層及單位 6/F - 12/F, 15/F - 23/F & 25/F 6樓至12樓、15樓至23樓及25樓												Tower 3 第3座 Floor and Unit 樓層及單位 26/F 26樓											
		A	B	C	D	E	F	G	H	J	K	M	N	A	B	C	D	E	F	G	H	J	K	M	N
Kitchen or Open Kitchen 廚房或開放式廚房	Lighting Point 燈位	3	-	-	-	-	-	-	-	-	-	-	3	-	-	-	-	-	-	-	-	-	-		
	13A Single Socket Outlet 13安培單位電插座	6	2	3	2	2	2	3	4	3	3	3	6	2	3	2	2	2	3	4	3	3	3		
	13A Twin Socket Outlet 13安培雙位電插座	1	1	1	1	1	1	1	-	-	-	-	1	1	1	1	1	1	-	-	-	-	-		
	Connection Unit for Electric Water Heater 電熱水爐接線位	1	1	1	1	1	1	1	1	1	1	1	1	1	1	1	1	1	1	1	1	1	1		
	Switch with Connection Unit for Exhaust Fan 抽氣扇開關掣連接線位	1	-	-	-	-	-	-	-	-	-	-	1	-	-	-	-	-	-	-	-	-	-		
	13A Twin Socket Outlet With USB 13安培雙位電插座連USB	1	1	1	1	1	1	1	1	1	1	1	1	1	1	1	1	1	1	1	1	1	1		
	Switch with Connection Unit for Steam Oven with Microwave 微波蒸烤焗爐開關掣連接線位	1	1	1	1	1	1	1	1	-	-	-	-	1	1	1	1	1	1	1	-	-	-		
	Towngas Connection Point 煤氣接駁點	1	1	1	1	1	1	1	1	1	1	1	1	1	1	1	1	1	1	1	1	1	1		
	Washing Machine Water Supply 洗衣機來水位	1	1	1	1	1	1	1	1	1	1	1	1	1	1	1	1	1	1	1	1	1	1		
	Washing Machine Drain 洗衣機去水位	1	1	1	1	1	1	1	1	1	1	1	1	1	1	1	1	1	1	1	1	1	1		
	Fire Service Sprinkler Head 消防花灑頭	-	3	3	3	3	3	3	3	2	2	2	2	-	3	3	3	3	3	3	2	2	2		
Miniature Circuit Breakers Board 總電掣箱	-	-	1	-	1	-	-	-	-	-	-	-	-	-	1	-	1	-	-	-	-	-			
Bathroom 浴室	Lighting Point 燈位	3	3	3	3	3	3	3	3	3	3	3	3	3	3	3	3	3	3	3	3	3			
	Switch with Connection Unit for Exhaust Fan 抽氣扇開關掣連接線位	-	1	1	1	1	1	-	-	1	1	1	-	-	1	1	1	1	-	-	1	1			
	Switch with Connection Unit for Thermo Ventilator 浴室實開關掣連接線位	1	1	1	1	1	1	1	1	1	1	1	1	1	1	1	1	1	1	1	1	1			
	32A TPN Weatherproof Switch with Connection Unit for Electric Water Heater 防水32A三相電熱水爐開關掣連接線位	1	1	1	1	1	1	1	1	1	1	1	1	1	1	1	1	1	1	1	1	1			
	13A Twin Socket Outlet With USB 13安培雙位電插座連USB	1	1	1	1	1	1	1	1	1	1	1	1	1	1	1	1	1	1	1	1	1			
Store Room 2 儲物室2	Lighting Point 燈位	/	/	/	/	/	/	1	/	/	/	/	/	/	/	/	/	1	/	/	/	/			
	Lighting Switch 燈掣	/	/	/	/	/	/	1	/	/	/	/	/	/	/	/	/	1	/	/	/	/			
	Switch for Air-conditioner Indoor Unit 冷氣機室內機開關掣	/	/	/	/	/	/	1	/	/	/	/	/	/	/	/	/	1	/	/	/	/			

## Notes:

- "1, 2, ....." as shown in the above table denotes the quantity of such provision(s) provided in the residential property.
- The symbol "-" as shown in the above table denotes "Not Provided".
- The symbol "/" as shown in the above table denotes "Not Applicable".
- 4/F, 13/F, 14/F and 24/F are omitted.

## 備註:

- 上表「1, 2, .....
- 上表“-”代表「不提供」。
- 上表“/”代表「不適用」。
- 不設4樓、13樓、14樓及24樓。



Schedule of Electrical &amp; Mechanical Provisions of Residential Units 住宅單位機電裝置數量說明表

Location 位置	Appliances 設備	Tower 3 第3座 Floor and Unit 樓層及單位 6/F - 12/F, 15/F - 23/F & 25/F 6樓至12樓、15樓至23樓及25樓												Tower 3 第3座 Floor and Unit 樓層及單位 26/F 26樓											
		A	B	C	D	E	F	G	H	J	K	M	N	A	B	C	D	E	F	G	H	J	K	M	N
Bedroom or Bedroom 1 睡房或睡房1	Lighting Point 燈位	1	1	1	1	1	1	1	/	/	/	/	/	1	1	1	1	1	1	/	/	/	/	/	
	Lighting Switch 燈掣	1	1	1	1	1	1	1	/	/	/	/	/	1	1	1	1	1	1	/	/	/	/	/	
	13A Single Socket Outlet 13安培單位電插座	1	1	1	1	1	1	1	/	/	/	/	/	1	1	1	1	1	1	/	/	/	/	/	
	TV / FM Outlet 電視 / 電台天線插座	1	1	1	1	1	1	1	/	/	/	/	/	1	1	1	1	1	1	/	/	/	/	/	
	Standby Data Box With Blank Cover 後備數據盒連蓋板	1	1	1	1	1	1	1	/	/	/	/	/	1	1	1	1	1	1	/	/	/	/	/	
	Switch for Air-conditioner Indoor Unit 冷氣機室內機開關掣	1	1	1	1	1	1	1	/	/	/	/	/	1	1	1	1	1	1	/	/	/	/	/	
	13A Twin Socket Outlet With USB 13安培雙位電插座連USB	1	1	1	1	1	1	1	/	/	/	/	/	1	1	1	1	1	1	/	/	/	/	/	
Bedroom 2 睡房2	Lighting Point 燈位	1	/	/	/	/	/	/	/	/	/	/	/	1	/	/	/	/	/	/	/	/	/	/	
	Lighting Switch 燈掣	1	/	/	/	/	/	/	/	/	/	/	/	1	/	/	/	/	/	/	/	/	/	/	
	13A Single Socket Outlet 13安培單位電插座	1	/	/	/	/	/	/	/	/	/	/	/	1	/	/	/	/	/	/	/	/	/	/	
	TV / FM Outlet 電視 / 電台天線插座	1	/	/	/	/	/	/	/	/	/	/	/	1	/	/	/	/	/	/	/	/	/	/	
	Standby Data Box With Blank Cover 後備數據盒連蓋板	1	/	/	/	/	/	/	/	/	/	/	/	1	/	/	/	/	/	/	/	/	/	/	
	Switch for Air-conditioner Indoor Unit 冷氣機室內機開關掣	1	/	/	/	/	/	/	/	/	/	/	/	1	/	/	/	/	/	/	/	/	/	/	
	13A Twin Socket Outlet With USB 13安培雙位電插座連USB	1	/	/	/	/	/	/	/	/	/	/	/	1	/	/	/	/	/	/	/	/	/	/	
Master Bedroom 主人睡房	Lighting Point 燈位	1	2	1	2	1	1	1	/	/	/	/	/	1	2	1	2	1	1	1	/	/	/	/	
	Lighting Switch 燈掣	3	1	1	1	1	1	1	/	/	/	/	/	3	1	1	1	1	1	1	/	/	/	/	
	13A Single Socket Outlet 13安培單位電插座	1	1	1	1	1	1	1	/	/	/	/	/	1	1	1	1	1	1	1	/	/	/	/	
	TV / FM Outlet 電視 / 電台天線插座	1	1	1	1	1	1	1	/	/	/	/	/	1	1	1	1	1	1	1	/	/	/	/	
	Standby Data Box With Blank Cover 後備數據盒連蓋板	1	1	1	1	1	1	1	/	/	/	/	/	1	1	1	1	1	1	1	/	/	/	/	
	Switch for Air-conditioner Indoor Unit 冷氣機室內機開關掣	1	1	1	1	1	1	1	/	/	/	/	/	1	1	1	1	1	1	1	/	/	/	/	
	13A Twin Socket Outlet With USB 13安培雙位電插座連USB	1	1	1	1	1	1	1	/	/	/	/	/	1	1	1	1	1	1	1	/	/	/	/	
	Switch with Connection Unit for Exhaust Fan 抽氣扇開關掣連接線位	1	-	-	-	-	-	-	/	/	/	/	/	1	-	-	-	-	-	-	/	/	/	/	
	Double Pole Switch 雙極開關掣	2	-	-	-	-	-	-	-	-	-	-	-	2	-	-	-	-	-	-	-	-	-	-	

## Notes:

- "1, 2, ....." as shown in the above table denotes the quantity of such provision(s) provided in the residential property.
- The symbol "-" as shown in the above table denotes "Not Provided".
- The symbol "/" as shown in the above table denotes "Not Applicable".
- 4/F, 13/F, 14/F and 24/F are omitted.

## 備註:

- 上表「1, 2, .....
- 上表「-」代表「不提供」。
- 上表「/」代表「不適用」。
- 不設4樓、13樓、14樓及24樓。

Schedule of Electrical &amp; Mechanical Provisions of Residential Units 住宅單位機電裝置數量說明表

Location 位置	Appliances 設備	Tower 3 第3座 Floor and Unit 樓層及單位 6/F - 12/F, 15/F - 23/F & 25/F 6樓至12樓、15樓至23樓及25樓												Tower 3 第3座 Floor and Unit 樓層及單位 26/F 26樓											
		A	B	C	D	E	F	G	H	J	K	M	N	A	B	C	D	E	F	G	H	J	K	M	N
Master Bathroom 主人浴室	Connection Unit for Thermo Ventilator 浴室竇接線位	1	/	/	/	/	/	/	/	/	/	/	/	1	/	/	/	/	/	/	/	/	/	/	
	32A TPN Weatherproof Switch with Connection Unit for Electric Water Heater 防水32A 三相電熱水爐開關掣連接線位	1	/	/	/	/	/	/	/	/	/	/	/	1	/	/	/	/	/	/	/	/	/	/	
	13A Twin Socket Outlet With USB 13安培雙位電插座連 USB	1	/	/	/	/	/	/	/	/	/	/	/	1	/	/	/	/	/	/	/	/	/	/	
	Lighting Point 燈位	3	/	/	/	/	/	/	/	/	/	/	/	3	/	/	/	/	/	/	/	/	/	/	
Balcony and Utility Room 露台及工作平台	Lighting Point 燈位	/	1	1	1	1	1	1	1	1	1	1	/	1	1	1	1	1	1	1	1	1	1		
	Gas Meter 煤氣錶	/	1	1	1	1	1	1	1	1	1	1	/	1	1	1	1	1	1	1	1	1	1		
Balcony 露台	Lighting Point 燈位	1	/	/	/	/	/	/	/	/	/	/	1	/	/	/	/	/	/	/	/	/	/		
	Gas Meter 煤氣錶	1	/	/	/	/	/	/	/	/	/	/	1	/	/	/	/	/	/	/	/	/	/		
Utility Room 工作平台	Lighting Point 燈位	1	/	/	/	/	/	/	/	/	/	/	1	/	/	/	/	/	/	/	/	/	/		
Air-conditioner Platform 冷氣機平台	Switch for Air-conditioner Outdoor Unit 冷氣機室外機開關掣	2	1	1	1	1	1	1	1	1	1	1	2	1	1	1	1	1	1	1	1	1	1		
Roof 天台	Lighting Point 燈位	/	/	/	/	/	/	/	/	/	/	/	6	5	5	4	6	6	5	4	4	4	4		
	13A Waterproof Single Socket Outlet 13安培單位防水電插座	/	/	/	/	/	/	/	/	/	/	/	1	1	1	1	1	1	1	1	1	2	1		
	Waterproof Lighting Switch 防水燈掣	/	/	/	/	/	/	/	/	/	/	/	1	1	1	1	1	1	1	1	1	1	1		

## Notes:

- "1, 2, ....." as shown in the above table denotes the quantity of such provision(s) provided in the residential property.
- The symbol "-" as shown in the above table denotes "Not Provided".
- The symbol "/" as shown in the above table denotes "Not Applicable".
- 4/F, 13/F, 14/F and 24/F are omitted.

## 備註:

- 上表「1, 2, ....."表示提供於該住宅物業內的裝置數量。
- 上表“-”代表「不提供」。
- 上表“/”代表「不適用」。
- 不設4樓、13樓、14樓及24樓。

Schedule of Electrical &amp; Mechanical Provisions of Residential Units 住宅單位機電裝置數量說明表

Location 位置	Appliances 設備	Tower 5 (5A) 第5座 (5A) Floor and Unit 樓層及單位 3/F 3樓											Tower 5 (5A) 第5座 (5A) Floor and Unit 樓層及單位 5/F 5樓													
		A	B	C	D	E	F	G	M	N	P	Q	A	B	C	D	E	F	G	J	K	M	N	P	Q	R
Main Entrance 大門入口	Door Bell Button 門鈴按鈕	1	1	1	1	1	1	1	1	1	1	1	1	1	1	1	1	1	1	1	1	1	1	1	1	
Living Room and Dining Room 客廳及飯廳	Lighting Point 燈位	4	3	5	4	4	2	2	3	3	2	2	4	3	5	4	4	2	2	2	3	3	3	2	2	2
	Lighting Switch 燈掣	6	4	6	4	5	4	4	5	5	4	4	6	4	6	4	5	4	4	4	5	5	5	4	4	4
	13A Single Socket Outlet 13安培單位電插座	2	-	2	1	-	-	-	-	-	1	1	2	-	2	1	-	-	-	-	-	-	-	1	1	1
	13A Twin Socket Outlet 13安培雙位電插座	2	2	2	2	2	2	2	2	2	2	2	2	2	2	2	2	2	2	2	2	2	2	2	2	2
	Telephone Outlet 電話插座	1	1	2	1	1	1	1	1	1	1	1	1	1	2	1	1	1	1	1	1	1	1	1	1	1
	TV / FM Outlet 電視 / 電台天線插座	1	1	2	1	1	1	1	1	1	1	1	1	1	2	1	1	1	1	1	1	1	1	1	1	1
	Incoming Data Box With Blank Cover 總數據插座連蓋板	1	1	1	1	1	1	1	1	1	1	1	1	1	1	1	1	1	1	1	1	1	1	1	1	1
	Standby Data Box With Blank Cover 後備數據盒連蓋板	-	-	1	-	-	-	-	-	-	-	-	-	-	1	-	-	-	-	-	-	-	-	-	-	-
	Switch for Air-conditioner Indoor Unit 冷氣機室內機開關掣	1	1	1	1	1	1	1	1	1	1	1	1	1	1	1	1	1	1	1	1	1	1	1	1	1
	Video Door Phone 視像對講機	1	1	1	1	1	1	1	1	1	1	1	1	1	1	1	1	1	1	1	1	1	1	1	1	1
	13A Single Socket Outlet With USB 13安培單位電插座連 USB	1	1	1	1	1	1	1	1	1	1	1	1	1	1	1	1	1	1	1	1	1	1	1	1	1
	13A Twin Socket Outlet With USB 13安培雙位電插座連 USB	-	-	1	-	-	-	-	-	-	-	-	-	-	1	-	-	-	-	-	-	-	-	-	-	-
	Miniature Circuit Breakers Board 總電掣箱	1	1	1	-	1	1	1	-	-	-	-	1	1	1	-	1	1	1	1	-	-	-	-	-	-
	Door Bell With Connection Unit 門鈴連接線位	1	1	1	1	1	1	1	1	1	1	1	1	1	1	1	1	1	1	-	1	1	1	1	1	1
	Switch with Connection Unit for Steam Oven with Microwave 微波蒸烤焗爐開關掣連接線位	-	-	-	-	-	-	-	-	-	1	1	-	-	-	-	-	-	-	-	-	-	-	1	1	1
	Switch with Connection Unit for Exhaust Fan 抽氣扇開關掣連接線位	-	-	1	1	-	-	-	-	-	-	-	-	-	1	1	-	-	-	-	-	-	-	-	-	-
Double Pole Switch 雙極開關掣	3	3	4	3	3	3	3	3	3	3	3	3	3	4	3	3	3	3	3	3	3	3	3	3	3	
Smoke Detector 煙霧探測器	1	1	-	1	1	1	1	1	1	1	1	1	1	-	1	1	1	1	1	1	1	1	1	1	1	
Kitchen or Open Kitchen 廚房或開放式廚房	Lighting Point 燈位	-	-	3	-	-	-	-	-	-	-	-	-	3	-	-	-	-	-	-	-	-	-	-	-	
	Lighting Switch 燈掣	-	-	-	-	1	-	-	-	-	-	-	-	-	-	1	-	-	-	-	-	-	-	-	-	
	13A Single Socket Outlet 13安培單位電插座	1	3	6	2	3	4	4	3	3	3	3	1	3	6	2	3	4	4	4	3	3	3	3	3	
	13A Twin Socket Outlet 13安培雙位電插座	1	1	1	1	1	-	-	-	-	-	-	1	1	1	1	1	-	-	-	-	-	-	-	-	

## Notes:

- "1, 2, ....." as shown in the above table denotes the quantity of such provision(s) provided in the residential property.
- The symbol "-" as shown in the above table denotes "Not Provided".
- The symbol "/" as shown in the above table denotes "Not Applicable".
- 4/F, 13/F, 14/F and 24/F are omitted.

## 備註:

- 上表「1, 2, .....,」表示提供於該住宅物業內的裝置數量。
- 上表“-”代表「不提供」。
- 上表“/”代表「不適用」。
- 不設4樓、13樓、14樓及24樓。

Schedule of Electrical &amp; Mechanical Provisions of Residential Units 住宅單位機電裝置數量說明表

Location 位置	Appliances 設備	Tower 5 (5A) 第5座 (5A) Floor and Unit 樓層及單位 3/F 3樓											Tower 5 (5A) 第5座 (5A) Floor and Unit 樓層及單位 5/F 5樓													
		A	B	C	D	E	F	G	M	N	P	Q	A	B	C	D	E	F	G	J	K	M	N	P	Q	R
Kitchen or Open Kitchen 廚房或開放式廚房	Connection Unit for Electric Water Heater 電熱水爐接線位	1	1	1	1	1	1	1	1	1	1	1	1	1	1	1	1	1	1	1	1	1	1	1	1	
	Switch with Connection Unit for Exhaust Fan 抽氣扇開關掣連接線位	-	-	1	-	-	-	-	-	-	-	-	-	-	-	1	-	-	-	-	-	-	-	-	-	-
	13A Twin Socket Outlet With USB 13安培雙位電插座連 USB	1	1	1	1	1	1	1	1	1	1	1	1	1	1	1	1	1	1	1	1	1	1	1	1	1
	Switch with Connection Unit for Steam Oven with Microwave 微波蒸烤焗爐開關掣連接線位	1	1	1	1	1	1	1	1	1	-	-	1	1	1	1	1	1	1	1	1	1	1	-	-	-
	Connection Unit for Electric Induction Hob 供電磁煮食爐接駁點	-	-	-	-	-	-	-	1	1	-	-	-	-	-	-	-	-	-	1	1	1	-	-	-	-
	Towngas Connection Point 煤氣接駁點	1	1	1	1	1	1	1	-	-	1	1	1	1	1	1	1	1	1	-	-	-	1	1	1	1
	Washing Machine Water Supply 洗衣機來水位	1	1	1	1	1	1	1	1	1	1	1	1	1	1	1	1	1	1	1	1	1	1	1	1	1
	Washing Machine Drain 洗衣機去水位	1	1	1	1	1	1	1	1	1	1	1	1	1	1	1	1	1	1	1	1	1	1	1	1	1
	Fire Service Sprinkler Head 消防花灑頭	3	3	-	4	4	4	4	3	4	3	3	3	3	3	-	4	4	4	4	4	3	3	4	3	3
	Miniature Circuit Breakers Board 總電掣箱	-	-	-	1	-	-	-	1	1	1	1	-	-	-	1	-	-	-	-	1	1	1	1	1	1
Door Bell Connection Unit 門鈴接線位	-	-	-	-	-	-	-	-	-	-	-	-	-	-	-	-	-	-	1	-	-	-	-	-	-	
Bathroom 浴室	Lighting Point 燈位	3	3	3	3	3	3	3	3	3	3	3	3	3	3	3	3	3	3	3	3	3	3	3	3	
	Switch with Connection Unit for Exhaust Fan 抽氣扇開關掣連接線位	-	1	-	-	1	1	1	1	1	1	1	-	1	-	-	1	1	1	1	1	1	1	1	1	
	Switch with Connection Unit for Thermo Ventilator 浴室寶開關掣連接線位	1	1	1	1	1	1	1	1	1	1	1	1	1	1	1	1	1	1	1	1	1	1	1	1	
	32A TPN Weatherproof Switch for Electric Water Heater 防水32A 三相電熱水爐開關掣連接線位	1	1	1	1	1	1	1	1	1	1	1	1	1	1	1	1	1	1	1	1	1	1	1	1	
	13A Twin Socket Outlet With USB 13安培雙位電插座連 USB	1	1	1	1	1	1	1	1	1	1	1	1	1	1	1	1	1	1	1	1	1	1	1	1	
Store Room 2 儲物室2	Lighting Point 燈位	1	/	1	/	/	/	/	/	/	/	1	/	1	/	/	/	/	/	/	/	/	/	/	/	
	Lighting Switch 燈掣	1	/	1	/	/	/	/	/	/	/	1	/	1	/	/	/	/	/	/	/	/	/	/	/	
	Switch for Air-conditioner Indoor Unit 冷氣機室內機開關掣	1	/	1	/	/	/	/	/	/	/	1	/	1	/	/	/	/	/	/	/	/	/	/	/	

## Notes:

- "1, 2, ....." as shown in the above table denotes the quantity of such provision(s) provided in the residential property.
- The symbol "-" as shown in the above table denotes "Not Provided".
- The symbol "/" as shown in the above table denotes "Not Applicable".
- 4/F, 13/F, 14/F and 24/F are omitted.

## 備註:

- 上表「1, 2, ....."表示提供於該住宅物業內的裝置數量。
- 上表“-”代表「不提供」。
- 上表“/”代表「不適用」。
- 不設4樓、13樓、14樓及24樓。

Schedule of Electrical &amp; Mechanical Provisions of Residential Units 住宅單位機電裝置數量說明表

Location 位置	Appliances 設備	Tower 5 (5A) 第5座 (5A) Floor and Unit 樓層及單位 3/F 3樓											Tower 5 (5A) 第5座 (5A) Floor and Unit 樓層及單位 5/F 5樓													
		A	B	C	D	E	F	G	M	N	P	Q	A	B	C	D	E	F	G	J	K	M	N	P	Q	R
Walk-In Closet 衣帽間	Lighting Point 燈位	/	/	/	/	/	1	1	/	/	/	/	/	/	/	/	/	1	1	/	/	/	/	/	/	/
	Lighting Switch 燈掣	/	/	/	/	/	1	1	/	/	/	/	/	/	/	/	/	1	1	/	/	/	/	/	/	/
	Switch for Air-conditioner Indoor Unit 冷氣機室內機開關掣	/	/	/	/	/	1	1	/	/	/	/	/	/	/	/	/	1	1	/	/	/	/	/	/	/
Bedroom or Bedroom 1 睡房或睡房 1	Lighting Point 燈位	1	1	1	1	1	1	1	/	/	1	1	1	1	1	1	1	1	1	1	/	/	/	1	1	1
	Lighting Switch 燈掣	1	1	1	1	1	1	1	/	/	1	1	1	1	1	1	1	1	1	1	/	/	/	1	1	1
	13A Single Socket Outlet 13安培單位電插座	1	1	1	1	1	1	1	/	/	1	1	1	1	1	1	1	1	1	1	/	/	/	1	1	1
	TV / FM Outlet 電視 / 電台天線插座	1	1	1	1	1	1	1	/	/	1	1	1	1	1	1	1	1	1	1	/	/	/	1	1	1
	Standby Data Box With Blank Cover 後備數據盒連蓋板	1	1	1	1	1	1	1	/	/	1	1	1	1	1	1	1	1	1	1	/	/	/	1	1	1
	Switch for Air-conditioner Indoor Unit 冷氣機室內機開關掣	1	1	1	1	1	1	1	/	/	1	1	1	1	1	1	1	1	1	1	/	/	/	1	1	1
13A Twin Socket Outlet With USB 13安培雙位電插座連 USB	1	1	1	1	1	1	1	/	/	1	1	1	1	1	1	1	1	1	1	/	/	/	1	1	1	
Bedroom 2 睡房 2	Lighting Point 燈位	/	/	1	/	/	/	/	/	/	/	/	/	/	/	1	/	/	/	/	/	/	/	/	/	/
	Lighting Switch 燈掣	/	/	1	/	/	/	/	/	/	/	/	/	/	/	1	/	/	/	/	/	/	/	/	/	/
	13A Single Socket Outlet 13安培單位電插座	/	/	1	/	/	/	/	/	/	/	/	/	/	1	/	/	/	/	/	/	/	/	/	/	/
	TV / FM Outlet 電視 / 電台天線插座	/	/	1	/	/	/	/	/	/	/	/	/	/	1	/	/	/	/	/	/	/	/	/	/	/
	Standby Data Box With Blank Cover 後備數據盒連蓋板	/	/	1	/	/	/	/	/	/	/	/	/	/	1	/	/	/	/	/	/	/	/	/	/	/
	Switch for Air-conditioner Indoor Unit 冷氣機室內機開關掣	/	/	1	/	/	/	/	/	/	/	/	/	/	1	/	/	/	/	/	/	/	/	/	/	/
13A Twin Socket Outlet With USB 13安培雙位電插座連 USB	/	/	1	/	/	/	/	/	/	/	/	/	/	1	/	/	/	/	/	/	/	/	/	/	/	
Master Bedroom 主人睡房	Lighting Point 燈位	1	1	1	1	1	/	/	/	/	/	/	1	1	1	1	1	/	/	/	/	/	/	/	/	/
	Lighting Switch 燈掣	1	1	2	1	1	/	/	/	/	/	/	1	1	2	1	1	/	/	/	/	/	/	/	/	/
	13A Single Socket Outlet 13安培單位電插座	1	1	1	1	1	/	/	/	/	/	/	1	1	1	1	1	/	/	/	/	/	/	/	/	/
	TV / FM Outlet 電視 / 電台天線插座	1	1	1	1	1	/	/	/	/	/	/	1	1	1	1	1	/	/	/	/	/	/	/	/	/
	Standby Data Box With Blank Cover 後備數據盒連蓋板	1	1	1	1	1	/	/	/	/	/	/	1	1	1	1	1	/	/	/	/	/	/	/	/	/
	Switch for Air-conditioner Indoor Unit 室內空調機開關掣	1	1	1	1	1	/	/	/	/	/	/	1	1	1	1	1	/	/	/	/	/	/	/	/	/
	13A Twin Socket Outlet With USB 13安培雙位電插座連 USB	1	1	1	1	1	/	/	/	/	/	/	1	1	1	1	1	/	/	/	/	/	/	/	/	/
Double Pole Switch 雙極開關掣	/	/	2	/	/	/	/	/	/	/	/	/	/	2	/	/	/	/	/	/	/	/	/	/	/	

## Notes:

- "1, 2, ....." as shown in the above table denotes the quantity of such provision(s) provided in the residential property.
- The symbol "-" as shown in the above table denotes "Not Provided".
- The symbol "/" as shown in the above table denotes "Not Applicable".
- 4/F, 13/F, 14/F and 24/F are omitted.

## 備註:

- 上表「1, 2, .....,」表示提供於該住宅物業內的裝置數量。
- 上表“-”代表「不提供」。
- 上表“/”代表「不適用」。
- 不設4樓、13樓、14樓及24樓。

Schedule of Electrical &amp; Mechanical Provisions of Residential Units 住宅單位機電裝置數量說明表

Location 位置	Appliances 設備	Tower 5 (5A) 第5座 (5A) Floor and Unit 樓層及單位 3/F 3樓											Tower 5 (5A) 第5座 (5A) Floor and Unit 樓層及單位 5/F 5樓													
		A	B	C	D	E	F	G	M	N	P	Q	A	B	C	D	E	F	G	J	K	M	N	P	Q	R
Master Bathroom 主人浴室	Lighting Point 燈位	/	/	3	/	/	/	/	/	/	/	/	/	/	3	/	/	/	/	/	/	/	/	/	/	/
	Switch with Connection Unit for Thermo Ventilator 浴室實關掣連接線位	/	/	1	/	/	/	/	/	/	/	/	/	/	1	/	/	/	/	/	/	/	/	/	/	/
	32A TPN Weatherproof Switch for Electric Water Heater 防水32A 三相電熱水爐開關掣連接線位	/	/	1	/	/	/	/	/	/	/	/	/	/	1	/	/	/	/	/	/	/	/	/	/	/
	13A Twin Socket Outlet With USB 13安培雙位電插座連 USB	/	/	1	/	/	/	/	/	/	/	/	/	/	1	/	/	/	/	/	/	/	/	/	/	/
Balcony and Utility Room 露台及工作平台	Lighting Point 燈位	/	/	/	/	/	/	/	/	/	/	/	1	/	1	1	1	1	/	/	/	/	1	1	1	
	Gas Meter 煤氣錶	/	/	/	/	/	/	/	/	/	/	/	1	/	1	1	1	1	/	/	/	/	1	1	1	
Balcony 露台	Lighting Point 燈位	/	/	/	/	/	/	/	/	/	/	1	/	1	/	/	/	/	/	1	1	/	/	/	/	
	Gas Meter 煤氣錶	/	/	/	/	/	/	/	/	/	/	1	/	1	/	/	/	/	/	-	-	/	/	/	/	
Utility Room 工作平台	Lighting Point 燈位	/	/	/	/	/	/	/	/	/	/	1	/	1	/	/	/	/	/	/	/	/	/	/	/	
Air-conditioner Platform 冷氣機平台	Switch for Air-conditioner Outdoor Unit 冷氣機室外機開關掣	/	/	/	/	/	/	/	/	/	/	2	1	2	1	1	1	1	/	/	1	1	1	1	1	
Flat Roof 平台	Lighting Point 燈位	6	2	3	3	2	2	2	4	3	4	2	/	/	/	/	/	/	2	2	/	/	/	/	/	
	13A Waterproof Single Socket Outlet 13安培單位防水電插座	1	1	1	1	1	1	1	1	1	1	1	/	/	/	/	/	/	1	1	/	/	/	/	/	
	Switch for Air-conditioner Outdoor Unit 冷氣機室外機開關掣	2	-	-	1	1	1	1	-	-	1	1	/	/	/	/	/	/	1	1	/	/	/	/	/	
	Gas Meter 煤氣錶	1	1	1	1	1	1	1	-	-	1	1	/	/	/	/	/	/	1	-	/	/	/	/	/	
Garden 花園	Lighting Point 燈位	/	1	-	/	/	/	/	/	/	/	/	/	/	/	/	/	/	/	/	/	/	/	/	/	
Inaccessible Common Flat Roof 維修平台	Switch for Air-conditioner Outdoor Unit 冷氣機室外機開關掣	/	1	2	/	/	/	/	1	1	/	/	/	/	/	/	/	/	/	/	/	/	/	/	/	

## Notes:

- "1, 2, ....." as shown in the above table denotes the quantity of such provision(s) provided in the residential property.
- The symbol "-" as shown in the above table denotes "Not Provided".
- The symbol "/" as shown in the above table denotes "Not Applicable".
- 4/F, 13/F, 14/F and 24/F are omitted.

## 備註:

- 上表「1, 2, ....."表示提供於該住宅物業內的裝置數量。
- 上表“-”代表「不提供」。
- 上表“/”代表「不適用」。
- 不設4樓、13樓、14樓及24樓。

Schedule of Electrical &amp; Mechanical Provisions of Residential Units 住宅單位機電裝置數量說明表

Location 位置	Appliances 設備	Tower 5 (5A) 第5座(5A) Floor and Unit 樓層及單位 6/F 6樓																Tower 5 (5A) 第5座(5A) Floor and Unit 樓層及單位 7/F 7樓															
		A	B	C	D	E	F	G	H	J	K	M	N	P	Q	R	A	B	C	D	E	F	G	H	J	K	M	N	P				
Main Entrance 大門入口	Door Bell Button 門鈴按鈕	1	1	1	1	1	1	1	1	1	1	1	1	1	1	1	1	1	1	1	1	1	1	1	1	1	1						
Living Room and Dining Room 客廳及飯廳	Lighting Point 燈位	4	3	5	4	4	2	2	2	2	3	3	3	2	2	2	4	3	5	4	4	2	2	2	3	3	3	2					
	Lighting Switch 燈掣	6	4	6	4	5	4	4	4	4	5	5	5	4	4	4	6	4	6	4	5	4	4	4	4	5	5	5	4				
	13A Single Socket Outlet 13安培單位電插座	2	-	2	1	-	-	-	-	-	-	-	-	1	1	1	2	-	2	1	-	-	-	-	-	-	-	1					
	13A Twin Socket Outlet 13安培雙位電插座	2	2	2	2	2	2	2	2	2	2	2	2	2	2	2	2	2	2	2	2	2	2	2	2	2	2	2	2				
	Telephone Outlet 電話插座	1	1	2	1	1	1	1	1	1	1	1	1	1	1	1	1	1	2	1	1	1	1	1	1	1	1	1					
	TV / FM Outlet 電視 / 電台天線插座	1	1	2	1	1	1	1	1	1	1	1	1	1	1	1	1	1	2	1	1	1	1	1	1	1	1	1					
	Incoming Data Box With Blank Cover 總數據插座連蓋板	1	1	1	1	1	1	1	1	1	1	1	1	1	1	1	1	1	1	1	1	1	1	1	1	1	1	1					
	Standby Data Box With Blank Cover 後備數據盒連蓋板	-	-	1	-	-	-	-	-	-	-	-	-	-	-	-	-	-	1	-	-	-	-	-	-	-	-	-					
	Switch for Air-conditioner Indoor Unit 冷氣機室內機開關掣	1	1	1	1	1	1	1	1	1	1	1	1	1	1	1	1	1	1	1	1	1	1	1	1	1	1	1					
	Video Door Phone 視像對講機	1	1	1	1	1	1	1	1	1	1	1	1	1	1	1	1	1	1	1	1	1	1	1	1	1	1	1					
	13A Single Socket Outlet With USB 13安培單位電插座連 USB	1	1	1	1	1	1	1	1	1	1	1	1	1	1	1	1	1	1	1	1	1	1	1	1	1	1	1					
	13A Twin Socket Outlet With USB 13安培雙位電插座連 USB	-	-	1	-	-	-	-	-	-	-	-	-	-	-	-	-	-	1	-	-	-	-	-	-	-	-	-					
	Miniature Circuit Breakers Board 總電掣箱	1	1	1	-	1	1	1	1	1	-	-	-	-	-	-	1	1	1	-	1	1	1	1	1	-	-	-					
	Door Bell With Connection Unit 門鈴連接線位	1	1	1	1	1	1	1	-	-	1	1	1	1	1	1	1	1	1	1	1	1	1	-	-	1	1	1					
	Switch with Connection Unit for Steam Oven with Microwave 微波蒸烤焗爐開關掣連接線位	-	-	-	-	-	-	-	-	-	-	-	-	-	1	1	1	-	-	-	-	-	-	-	-	-	-	1					
	Switch with Connection Unit for Exhaust Fan 抽氣扇開關掣連接線位	-	-	1	1	-	-	-	-	-	-	-	-	-	-	-	-	-	1	1	-	-	-	-	-	-	-	-					
	Double Pole Switch 雙極開關掣	3	3	4	3	3	3	3	3	3	3	3	3	3	3	3	3	3	4	3	3	3	3	3	3	3	3	3					
Smoke Detector 煙霧探測器	1	1	-	1	1	1	1	1	1	1	1	1	1	1	1	1	1	-	1	1	1	1	1	1	1	1	1						
Kitchen or Open Kitchen 廚房或開放式廚房	Lighting Point 燈位	-	-	3	-	-	-	-	-	-	-	-	-	-	-	-	-	3	-	-	-	-	-	-	-	-	-						
	Lighting Switch 燈掣	-	-	-	-	1	-	-	-	-	-	-	-	-	-	-	-	-	-	1	-	-	-	-	-	-	-						
	13A Single Socket Outlet 13安培單位電插座	1	3	6	2	3	4	4	4	4	3	3	3	3	3	3	1	3	6	2	3	4	4	4	4	3	3	3					
	13A Twin Socket Outlet 13安培雙位電插座	1	1	1	1	1	-	-	-	-	-	-	-	-	-	-	1	1	1	1	1	-	-	-	-	-	-	-					

## Notes:

- "1, 2, ....." as shown in the above table denotes the quantity of such provision(s) provided in the residential property.
- The symbol "-" as shown in the above table denotes "Not Provided".
- The symbol "/" as shown in the above table denotes "Not Applicable".
- 4/F, 13/F, 14/F and 24/F are omitted.

## 備註:

- 上表「1, 2, .....
- 上表“-”代表「不提供」。
- 上表“/”代表「不適用」。
- 不設4樓、13樓、14樓及24樓。

Schedule of Electrical &amp; Mechanical Provisions of Residential Units 住宅單位機電裝置數量說明表

Location 位置	Appliances 設備	Tower 5 (5A) 第5座(5A) Floor and Unit 樓層及單位 6/F 6樓														Tower 5 (5A) 第5座(5A) Floor and Unit 樓層及單位 7/F 7樓													
		A	B	C	D	E	F	G	H	J	K	M	N	P	Q	R	A	B	C	D	E	F	G	H	J	K	M	N	P
Kitchen or Open Kitchen 廚房或開放式廚房	Connection Unit for Electric Water Heater 電熱水爐接線位	1	1	1	1	1	1	1	1	1	1	1	1	1	1	1	1	1	1	1	1	1	1	1	1	1	1	1	
	Switch with Connection Unit for Exhaust Fan 抽氣扇開關掣連接線位	-	-	1	-	-	-	-	-	-	-	-	-	-	-	-	-	-	1	-	-	-	-	-	-	-	-	-	
	13A Twin Socket Outlet With USB 13安培雙位電插座連 USB	1	1	1	1	1	1	1	1	1	1	1	1	1	1	1	1	1	1	1	1	1	1	1	1	1	1	1	
	Switch with Connection Unit for Steam Oven with Microwave 微波蒸烤焗爐開關掣連接線位	1	1	1	1	1	1	1	1	1	1	1	1	-	-	-	1	1	1	1	1	1	1	1	1	1	1	-	
	Connection Unit for Electric Induction Hob 供電磁煮食爐接駁點	-	-	-	-	-	-	-	-	-	1	1	1	-	-	-	-	-	-	-	-	-	-	-	1	1	1	-	
	Towngas Connection Point 煤氣接駁點	1	1	1	1	1	1	1	1	1	-	-	-	1	1	1	1	1	1	1	1	1	1	1	1	-	-	1	
	Washing Machine Water Supply 洗衣機來水位	1	1	1	1	1	1	1	1	1	1	1	1	1	1	1	1	1	1	1	1	1	1	1	1	1	1	1	
	Washing Machine Drain 洗衣機去水位	1	1	1	1	1	1	1	1	1	1	1	1	1	1	1	1	1	1	1	1	1	1	1	1	1	1	1	
	Fire Service Sprinkler Head 消防花灑頭	3	3	-	4	4	4	4	4	4	3	3	4	3	3	3	3	3	-	4	4	4	4	4	4	3	3	4	3
	Miniature Circuit Breakers Board 總電掣箱	-	-	-	1	-	-	-	-	-	1	1	1	1	1	1	-	-	-	1	-	-	-	-	1	1	1	1	
Door Bell Connection Unit 門鈴接線位	-	-	-	-	-	-	-	1	1	-	-	-	-	-	-	-	-	-	-	-	-	1	1	-	-	-	-		
Bathroom 浴室	Lighting Point 燈位	3	3	3	3	3	3	3	3	3	3	3	3	3	3	3	3	3	3	3	3	3	3	3	3	3	3	3	
	Switch with Connection Unit for Exhaust Fan 抽氣扇開關掣連接線位	-	1	-	-	1	1	1	1	1	1	1	1	1	1	1	-	1	-	-	1	1	1	1	1	1	1	1	
	Switch with Connection Unit for Thermo Ventilator 浴室寶開關掣連接線位	1	1	1	1	1	1	1	1	1	1	1	1	1	1	1	1	1	1	1	1	1	1	1	1	1	1	1	
	32A TPN Weatherproof Switch for Electric Water Heater 防水32A 三相電熱水爐開關掣連接線位	1	1	1	1	1	1	1	1	1	1	1	1	1	1	1	1	1	1	1	1	1	1	1	1	1	1	1	
Store Room 2 儲物室2	13A Twin Socket Outlet With USB 13安培雙位電插座連 USB	1	1	1	1	1	1	1	1	1	1	1	1	1	1	1	1	1	1	1	1	1	1	1	1	1	1		
	Lighting Point 燈位	1	/	1	/	/	/	/	/	/	/	/	/	/	/	/	1	/	1	/	/	/	/	/	/	/	/	/	
	Lighting Switch 燈掣	1	/	1	/	/	/	/	/	/	/	/	/	/	/	/	1	/	1	/	/	/	/	/	/	/	/	/	
Store Room 2 儲物室2	Switch for Air-conditioner Indoor Unit 冷氣機室內機開關掣	1	/	1	/	/	/	/	/	/	/	/	/	/	/	1	/	1	/	/	/	/	/	/	/	/	/		

## Notes:

- "1, 2, ....." as shown in the above table denotes the quantity of such provision(s) provided in the residential property.
- The symbol "-" as shown in the above table denotes "Not Provided".
- The symbol "/" as shown in the above table denotes "Not Applicable".
- 4/F, 13/F, 14/F and 24/F are omitted.

## 備註:

- 上表「1, 2, .....
- 上表「-」代表「不提供」。
- 上表「/」代表「不適用」。
- 不設4樓、13樓、14樓及24樓。



Schedule of Electrical &amp; Mechanical Provisions of Residential Units 住宅單位機電裝置數量說明表

Location 位置	Appliances 設備	Tower 5 (5A) 第5座(5A) Floor and Unit 樓層及單位 6/F 6樓																Tower 5 (5A) 第5座(5A) Floor and Unit 樓層及單位 7/F 7樓															
		A	B	C	D	E	F	G	H	J	K	M	N	P	Q	R	A	B	C	D	E	F	G	H	J	K	M	N	P				
Walk-In Closet 衣帽間	Lighting Point 燈位	/	/	/	/	/	1	1	/	/	/	/	/	/	/	/	/	/	/	/	1	1	/	/	/	/	/	/					
	Lighting Switch 燈掣	/	/	/	/	/	1	1	/	/	/	/	/	/	/	/	/	/	/	/	1	1	/	/	/	/	/	/					
	Switch for Air-conditioner Indoor Unit 冷氣機室內機開關掣	/	/	/	/	/	1	1	/	/	/	/	/	/	/	/	/	/	/	/	1	1	/	/	/	/	/	/					
Bedroom or Bedroom 1 睡房或睡房1	Lighting Point 燈位	1	1	1	1	1	1	1	1	1	/	/	/	1	1	1	1	1	1	1	1	1	1	1	1	/	/	/	1				
	Lighting Switch 燈掣	1	1	1	1	1	1	1	1	1	/	/	/	1	1	1	1	1	1	1	1	1	1	1	1	/	/	/	1				
	13A Single Socket Outlet 13安培單位電插座	1	1	1	1	1	1	1	1	1	/	/	/	1	1	1	1	1	1	1	1	1	1	1	1	/	/	/	1				
	TV / FM Outlet 電視 / 電台天線插座	1	1	1	1	1	1	1	1	1	/	/	/	1	1	1	1	1	1	1	1	1	1	1	1	/	/	/	1				
	Standby Data Box With Blank Cover 後備數據盒連蓋板	1	1	1	1	1	1	1	1	1	/	/	/	1	1	1	1	1	1	1	1	1	1	1	1	/	/	/	1				
	Switch for Air-conditioner Indoor Unit 冷氣機室內機開關掣	1	1	1	1	1	1	1	1	1	/	/	/	1	1	1	1	1	1	1	1	1	1	1	1	/	/	/	1				
	13A Twin Socket Outlet With USB 13安培雙位電插座連USB	1	1	1	1	1	1	1	1	1	/	/	/	1	1	1	1	1	1	1	1	1	1	1	1	/	/	/	1				
Bedroom 2 睡房2	Lighting Point 燈位	/	/	1	/	/	/	/	/	/	/	/	/	/	/	/	/	/	1	/	/	/	/	/	/	/	/	/					
	Lighting Switch 燈掣	/	/	1	/	/	/	/	/	/	/	/	/	/	/	/	/	/	1	/	/	/	/	/	/	/	/	/					
	13A Single Socket Outlet 13安培單位電插座	/	/	1	/	/	/	/	/	/	/	/	/	/	/	/	/	/	1	/	/	/	/	/	/	/	/	/					
	TV / FM Outlet 電視 / 電台天線插座	/	/	1	/	/	/	/	/	/	/	/	/	/	/	/	/	/	1	/	/	/	/	/	/	/	/	/					
	Standby Data Box With Blank Cover 後備數據盒連蓋板	/	/	1	/	/	/	/	/	/	/	/	/	/	/	/	/	/	1	/	/	/	/	/	/	/	/	/					
	Switch for Air-conditioner Indoor Unit 冷氣機室內機開關掣	/	/	1	/	/	/	/	/	/	/	/	/	/	/	/	/	/	1	/	/	/	/	/	/	/	/	/					
	13A Twin Socket Outlet With USB 13安培雙位電插座連USB	/	/	1	/	/	/	/	/	/	/	/	/	/	/	/	/	/	1	/	/	/	/	/	/	/	/	/					
Master Bedroom 主人睡房	Lighting Point 燈位	1	1	1	1	1	/	/	/	/	/	/	/	/	/	/	1	1	1	1	1	/	/	/	/	/	/	/					
	Lighting Switch 燈掣	1	1	2	1	1	/	/	/	/	/	/	/	/	/	/	1	1	2	1	1	/	/	/	/	/	/	/					
	13A Single Socket Outlet 13安培單位電插座	1	1	1	1	1	/	/	/	/	/	/	/	/	/	/	1	1	1	1	1	/	/	/	/	/	/	/					
	TV / FM Outlet 電視 / 電台天線插座	1	1	1	1	1	/	/	/	/	/	/	/	/	/	/	1	1	1	1	1	/	/	/	/	/	/	/					
	Standby Data Box With Blank Cover 後備數據盒連蓋板	1	1	1	1	1	/	/	/	/	/	/	/	/	/	/	1	1	1	1	1	/	/	/	/	/	/	/					
	Switch for Air-conditioner Indoor Unit 室內空調機開關掣	1	1	1	1	1	/	/	/	/	/	/	/	/	/	/	1	1	1	1	1	/	/	/	/	/	/	/					
	13A Twin Socket Outlet With USB 13安培雙位電插座連USB	1	1	1	1	1	/	/	/	/	/	/	/	/	/	/	1	1	1	1	1	/	/	/	/	/	/	/					
	Double Pole Switch 雙極開關掣	/	/	2	/	/	/	/	/	/	/	/	/	/	/	/	/	/	2	/	/	/	/	/	/	/	/	/					

## Notes:

- "1, 2, ....." as shown in the above table denotes the quantity of such provision(s) provided in the residential property.
- The symbol "-" as shown in the above table denotes "Not Provided".
- The symbol "/" as shown in the above table denotes "Not Applicable".
- 4/F, 13/F, 14/F and 24/F are omitted.

## 備註:

- 上表「1, 2, .....
- 上表“-”代表「不提供」。
- 上表“/”代表「不適用」。
- 不設4樓、13樓、14樓及24樓。

Schedule of Electrical &amp; Mechanical Provisions of Residential Units 住宅單位機電裝置數量說明表

Location 位置	Appliances 設備	Tower 5 (5A) 第5座(5A) Floor and Unit 樓層及單位 6/F 6樓														Tower 5 (5A) 第5座(5A) Floor and Unit 樓層及單位 7/F 7樓													
		A	B	C	D	E	F	G	H	J	K	M	N	P	Q	R	A	B	C	D	E	F	G	H	J	K	M	N	P
Master Bathroom 主人浴室	Lighting Point 燈位	/	/	3	/	/	/	/	/	/	/	/	/	/	/	/	/	/	3	/	/	/	/	/	/	/	/	/	
	Switch with Connection Unit for Thermo Ventilator 浴室寶開關掣連接線位	/	/	1	/	/	/	/	/	/	/	/	/	/	/	/	/	/	1	/	/	/	/	/	/	/	/	/	
	32A TPN Weatherproof Switch for Electric Water Heater 防水32A 三相電熱水爐開關掣連接線位	/	/	1	/	/	/	/	/	/	/	/	/	/	/	/	/	/	1	/	/	/	/	/	/	/	/	/	
	13A Twin Socket Outlet With USB 13安培雙位電插座連USB	/	/	1	/	/	/	/	/	/	/	/	/	/	/	/	/	/	1	/	/	/	/	/	/	/	/	/	
Balcony and Utility Room 露台及工作平台	Lighting Point 燈位	/	1	/	1	1	1	1	/	1	/	/	1	1	1	/	1	/	1	1	1	1	1	1	/	/	/	1	
	Gas Meter 煤氣錶	/	1	/	1	1	1	1	/	1	/	/	1	1	1	/	1	/	1	1	1	1	1	1	/	/	/	1	
Balcony 露台	Lighting Point 燈位	1	/	1	/	/	/	/	/	/	1	1	1	/	/	/	1	/	1	/	/	/	/	/	1	1	1	/	
	Gas Meter 煤氣錶	1	/	1	/	/	/	/	/	/	-	-	-	/	/	/	1	/	1	/	/	/	/	/	-	-	-	/	
Utility Room 工作平台	Lighting Point 燈位	1	/	1	/	/	/	/	/	/	/	/	/	/	/	1	/	1	/	/	/	/	/	/	/	/	/	/	
Air-conditioner Platform 冷氣機平台	Switch for Air-conditioner Outdoor Unit 冷氣機室外機開關掣	2	1	2	1	1	1	1	/	1	1	1	1	1	1	2	1	2	1	1	1	1	1	1	1	1	1	1	
Flat Roof 平台	Lighting Point 燈位	/	/	/	/	/	/	/	2	/	/	/	/	/	/	/	/	/	/	/	/	/	/	/	/	/	/	/	
	13A Waterproof Single Socket Outlet 13安培單位防水電插座	/	/	/	/	/	/	/	1	/	/	/	/	/	/	/	/	/	/	/	/	/	/	/	/	/	/	/	
	Switch for Air-conditioner Outdoor Unit 冷氣機室外機開關掣	/	/	/	/	/	/	/	1	/	/	/	/	/	/	/	/	/	/	/	/	/	/	/	/	/	/	/	
	Gas Meter 煤氣錶	/	/	/	/	/	/	/	1	/	/	/	/	/	/	/	/	/	/	/	/	/	/	/	/	/	/	/	

## Notes:

- "1, 2, ....." as shown in the above table denotes the quantity of such provision(s) provided in the residential property.
- The symbol "-" as shown in the above table denotes "Not Provided".
- The symbol "/" as shown in the above table denotes "Not Applicable".
- 4/F, 13/F, 14/F and 24/F are omitted.

## 備註:

- 上表「1, 2, .....
- 上表“-”代表「不提供」。
- 上表“/”代表「不適用」。
- 不設4樓、13樓、14樓及24樓。

Schedule of Electrical &amp; Mechanical Provisions of Residential Units 住宅單位機電裝置數量說明表

Location 位置	Appliances 設備	Tower 5 (5A) 第5座 (5A) Floor and Unit 樓層及單位 8/F 8樓												Tower 5 (5A) 第5座 (5A) Floor and Unit 樓層及單位 9/F 9樓													
		A	B	C	D	E	F	G	H	J	K	M	N	P	A	B	C	D	E	F	G	H	J	K	M	N	P
Main Entrance 大門入口	Door Bell Button 門鈴按鈕	1	1	1	1	1	1	1	1	1	1	1	1	1	1	1	1	1	1	1	1	1	1	1	1		
Living Room and Dining Room 客廳及飯廳	Lighting Point 燈位	4	3	5	4	4	2	2	2	2	3	3	3	2	4	3	5	3	4	2	2	2	2	3	3	3	2
	Lighting Switch 燈掣	6	4	6	4	5	4	4	4	4	5	5	5	4	6	4	6	4	5	4	4	4	4	5	5	5	4
	13A Single Socket Outlet 13安培單位電插座	2	-	2	1	-	-	-	-	-	-	-	-	1	2	-	2	1	-	-	-	-	-	-	-	-	1
	13A Twin Socket Outlet 13安培雙位電插座	2	2	2	2	2	2	2	2	2	2	2	2	2	2	2	2	2	2	2	2	2	2	2	2	2	2
	Telephone Outlet 電話插座	1	1	2	1	1	1	1	1	1	1	1	1	1	1	1	2	1	1	1	1	1	1	1	1	1	1
	TV / FM Outlet 電視 / 電台天線插座	1	1	2	1	1	1	1	1	1	1	1	1	1	1	1	2	1	1	1	1	1	1	1	1	1	1
	Incoming Data Box With Blank Cover 總數據插座連蓋板	1	1	1	1	1	1	1	1	1	1	1	1	1	1	1	1	1	1	1	1	1	1	1	1	1	1
	Standby Data Box With Blank Cover 後備數據盒連蓋板	-	-	1	-	-	-	-	-	-	-	-	-	-	-	-	1	-	-	-	-	-	-	-	-	-	-
	Switch for Air-conditioner Indoor Unit 冷氣機室內機開關掣	1	1	1	1	1	1	1	1	1	1	1	1	1	1	1	1	1	1	1	1	1	1	1	1	1	1
	Video Door Phone 視像對講機	1	1	1	1	1	1	1	1	1	1	1	1	1	1	1	1	1	1	1	1	1	1	1	1	1	1
	13A Single Socket Outlet With USB 13安培單位電插座連 USB	1	1	1	1	1	1	1	1	1	1	1	1	1	1	1	1	1	1	1	1	1	1	1	1	1	1
	13A Twin Socket Outlet With USB 13安培雙位電插座連 USB	-	-	1	-	-	-	-	-	-	-	-	-	-	-	-	1	-	-	-	-	-	-	-	-	-	-
	Miniature Circuit Breakers Board 總電掣箱	1	1	1	-	1	1	1	1	1	-	-	-	-	1	1	1	-	1	1	1	1	1	-	-	-	-
	Door Bell With Connection Unit 門鈴連接線位	1	1	1	1	1	1	1	-	-	1	1	1	1	1	1	1	1	1	1	1	-	-	1	1	1	1
	Switch with Connection Unit for Steam Oven with Microwave 微波蒸烤焗爐開關掣連接線位	-	-	-	-	-	-	-	-	-	-	-	-	1	-	-	-	-	-	-	-	-	-	-	-	-	1
	Switch with Connection Unit for Exhaust Fan 抽氣扇開關掣連接線位	-	-	1	1	-	-	-	-	-	-	-	-	-	-	-	1	-	-	-	-	-	-	-	-	-	-
Double Pole Switch 雙極開關掣	3	3	4	3	3	3	3	3	3	3	3	3	3	3	3	4	3	3	3	3	3	3	3	3	3	3	
Smoke Detector 煙霧探測器	1	1	-	1	1	1	1	1	1	1	1	1	1	1	1	-	1	1	1	1	1	1	1	1	1	1	

## Notes:

- "1, 2, ....." as shown in the above table denotes the quantity of such provision(s) provided in the residential property.
- The symbol "-" as shown in the above table denotes "Not Provided".
- The symbol "/" as shown in the above table denotes "Not Applicable".
- 4/F, 13/F, 14/F and 24/F are omitted.

## 備註:

- 上表「1, 2, ....."表示提供於該住宅物業內的裝置數量。
- 上表“-”代表「不提供」。
- 上表“/”代表「不適用」。
- 不設4樓、13樓、14樓及24樓。

Schedule of Electrical &amp; Mechanical Provisions of Residential Units 住宅單位機電裝置數量說明表

Location 位置	Appliances 設備	Tower 5 (5A) 第5座 (5A) Floor and Unit 樓層及單位 8/F 8樓												Tower 5 (5A) 第5座 (5A) Floor and Unit 樓層及單位 9/F 9樓											
		A	B	C	D	E	F	G	H	J	K	M	N	P	A	B	C	D	E	F	G	H	J	K	M
Kitchen or Open Kitchen 廚房或開放式廚房	Lighting Point 燈位	-	-	3	-	-	-	-	-	-	-	-	-	-	-	-	3	-	-	-	-	-	-	-	-
	Lighting Switch 燈掣	-	-	-	-	1	-	-	-	-	-	-	-	-	-	-	-	1	-	-	-	-	-	-	-
	13A Single Socket Outlet 13安培單位電插座	1	3	6	2	3	4	4	4	4	3	3	3	3	1	3	6	2	3	4	4	4	3	3	3
	13A Twin Socket Outlet 13安培雙位電插座	1	1	1	1	1	-	-	-	-	-	-	-	-	1	1	1	1	1	-	-	-	-	-	-
	Connection Unit for Electric Water Heater 電熱水爐接線位	1	1	1	1	1	1	1	1	1	1	1	1	1	1	1	1	1	1	1	1	1	1	1	1
	Switch with Connection Unit for Exhaust Fan 抽氣扇開關掣連接線位	-	-	1	-	-	-	-	-	-	-	-	-	-	-	-	1	-	-	-	-	-	-	-	-
	13A Twin Socket Outlet With USB 13安培雙位電插座連 USB	1	1	1	1	1	1	1	1	1	1	1	1	1	1	1	1	1	1	1	1	1	1	1	1
	Switch with Connection Unit for Steam Oven with Microwave 微波蒸烤焗爐開關掣連接線位	1	1	1	1	1	1	1	1	1	1	1	1	-	1	1	1	1	1	1	1	1	1	1	-
	Connection Unit for Electric Induction Hob 供電磁煮食爐接駁點	-	-	-	-	-	-	-	-	-	1	1	1	-	-	-	-	-	-	-	-	-	1	1	-
	Towngas Connection Point 煤氣接駁點	1	1	1	1	1	1	1	1	1	-	-	-	1	1	1	1	1	1	1	1	1	-	-	1
	Washing Machine Water Supply 洗衣機來水位	1	1	1	1	1	1	1	1	1	1	1	1	1	1	1	1	1	1	1	1	1	1	1	1
	Washing Machine Drain 洗衣機去水位	1	1	1	1	1	1	1	1	1	1	1	1	1	1	1	1	1	1	1	1	1	1	1	1
	Fire Service Sprinkler Head 消防花灑頭	3	3	-	4	4	4	4	4	4	3	3	4	3	3	3	-	4	4	4	4	4	3	3	4
	Miniature Circuit Breakers Board 總電掣箱	-	-	-	1	-	-	-	-	-	1	1	1	1	-	-	-	1	-	-	-	-	1	1	1
Door Bell Connection Unit 門鈴接線位	-	-	-	-	-	-	-	1	1	-	-	-	-	-	-	-	-	-	-	1	1	-	-	-	
Bathroom 浴室	Lighting Point 燈位	3	3	3	3	3	3	3	3	3	3	3	3	3	3	3	3	3	3	3	3	3	3	3	
	Switch with Connection Unit for Exhaust Fan 抽氣扇開關掣連接線位	-	1	-	-	1	1	1	1	1	1	1	1	-	1	-	-	1	1	1	1	1	1	1	
	Switch with Connection Unit for Thermo Ventilator 浴室實開關掣連接線位	1	1	1	1	1	1	1	1	1	1	1	1	1	1	1	1	1	1	1	1	1	1	1	
	32A TPN Weatherproof Switch for Electric Water Heater 防水32A 三相電熱水爐開關掣連接線位	1	1	1	1	1	1	1	1	1	1	1	1	1	1	1	1	1	1	1	1	1	1	1	
	13A Twin Socket Outlet With USB 13安培雙位電插座連 USB	1	1	1	1	1	1	1	1	1	1	1	1	1	1	1	1	1	1	1	1	1	1	1	

## Notes:

- "1, 2, ....." as shown in the above table denotes the quantity of such provision(s) provided in the residential property.
- The symbol "-" as shown in the above table denotes "Not Provided".
- The symbol "/" as shown in the above table denotes "Not Applicable".
- 4/F, 13/F, 14/F and 24/F are omitted.

## 備註:

- 上表「1, 2, ....."表示提供於該住宅物業內的裝置數量。
- 上表“-”代表「不提供」。
- 上表“/”代表「不適用」。
- 不設4樓、13樓、14樓及24樓。

Schedule of Electrical &amp; Mechanical Provisions of Residential Units 住宅單位機電裝置數量說明表

Location 位置	Appliances 設備	Tower 5 (5A) 第5座 (5A) Floor and Unit 樓層及單位 8/F 8樓												Tower 5 (5A) 第5座 (5A) Floor and Unit 樓層及單位 9/F 9樓											
		A	B	C	D	E	F	G	H	J	K	M	N	P	A	B	C	D	E	F	G	H	J	K	M
Store Room 2 儲物室 2	Lighting Point 燈位	1	/	1	/	/	/	/	/	/	/	/	/	1	/	1	/	/	/	/	/	/	/	/	/
	Lighting Switch 燈掣	1	/	1	/	/	/	/	/	/	/	/	/	1	/	1	/	/	/	/	/	/	/	/	/
	Switch for Air-conditioner Indoor Unit 冷氣機室內機開關掣	1	/	1	/	/	/	/	/	/	/	/	/	1	/	1	/	/	/	/	/	/	/	/	/
Walk-In Closet 衣帽間	Lighting Point 燈位	/	/	/	/	/	1	1	/	/	/	/	/	/	/	/	/	1	1	/	/	/	/	/	
	Lighting Switch 燈掣	/	/	/	/	/	1	1	/	/	/	/	/	/	/	/	/	1	1	/	/	/	/	/	
	Switch for Air-conditioner Indoor Unit 冷氣機室內機開關掣	/	/	/	/	/	1	1	/	/	/	/	/	/	/	/	/	1	1	/	/	/	/	/	
Bedroom or Bedroom 1 睡房或睡房 1	Lighting Point 燈位	1	1	1	1	1	1	1	1	1	/	/	/	1	1	1	1	1	1	1	1	1	/	/	1
	Lighting Switch 燈掣	1	1	1	1	1	1	1	1	1	/	/	/	1	1	1	1	1	1	1	1	1	/	/	1
	13A Single Socket Outlet 13安培單位電插座	1	1	1	1	1	1	1	1	1	/	/	/	1	1	1	1	1	1	1	1	1	/	/	1
	TV / FM Outlet 電視 / 電台天線插座	1	1	1	1	1	1	1	1	1	/	/	/	1	1	1	1	1	1	1	1	1	/	/	1
	Standby Data Box With Blank Cover 後備數據盒連蓋板	1	1	1	1	1	1	1	1	1	/	/	/	1	1	1	1	1	1	1	1	1	/	/	1
	Switch for Air-conditioner Indoor Unit 冷氣機室內機開關掣	1	1	1	1	1	1	1	1	1	/	/	/	1	1	1	1	1	1	1	1	1	/	/	1
	13A Twin Socket Outlet With USB 13安培雙位電插座連 USB	1	1	1	1	1	1	1	1	1	/	/	/	1	1	1	1	1	1	1	1	1	/	/	1
Bedroom 2 睡房 2	Lighting Point 燈位	/	/	1	/	/	/	/	/	/	/	/	/	/	/	1	/	/	/	/	/	/	/	/	
	Lighting Switch 燈掣	/	/	1	/	/	/	/	/	/	/	/	/	/	/	1	/	/	/	/	/	/	/	/	
	13A Single Socket Outlet 13安培單位電插座	/	/	1	/	/	/	/	/	/	/	/	/	/	/	1	/	/	/	/	/	/	/	/	
	TV / FM Outlet 電視 / 電台天線插座	/	/	1	/	/	/	/	/	/	/	/	/	/	/	1	/	/	/	/	/	/	/	/	
	Standby Data Box With Blank Cover 後備數據盒連蓋板	/	/	1	/	/	/	/	/	/	/	/	/	/	/	1	/	/	/	/	/	/	/	/	
	Switch for Air-conditioner Indoor Unit 冷氣機室內機開關掣	/	/	1	/	/	/	/	/	/	/	/	/	/	/	1	/	/	/	/	/	/	/	/	
	13A Twin Socket Outlet With USB 13安培雙位電插座連 USB	/	/	1	/	/	/	/	/	/	/	/	/	/	/	1	/	/	/	/	/	/	/	/	

## Notes:

- “1, 2, ……” as shown in the above table denotes the quantity of such provision(s) provided in the residential property.
- The symbol “-” as shown in the above table denotes “Not Provided”.
- The symbol “/” as shown in the above table denotes “Not Applicable”.
- 4/F, 13/F, 14/F and 24/F are omitted.

## 備註:

- 上表「1, 2, ……」表示提供於該住宅物業內的裝置數量。
- 上表“-”代表「不提供」。
- 上表“/”代表「不適用」。
- 不設4樓、13樓、14樓及24樓。

Schedule of Electrical &amp; Mechanical Provisions of Residential Units 住宅單位機電裝置數量說明表

Location 位置	Appliances 設備	Tower 5 (5A) 第5座 (5A) Floor and Unit 樓層及單位 8/F 8樓												Tower 5 (5A) 第5座 (5A) Floor and Unit 樓層及單位 9/F 9樓											
		A	B	C	D	E	F	G	H	J	K	M	N	P	A	B	C	D	E	F	G	H	J	K	M
Master Bedroom 主人睡房	Lighting Point 燈位	1	1	1	1	1	/	/	/	/	/	/	/	1	1	1	1	1	/	/	/	/	/	/	/
	Lighting Switch 燈掣	1	1	2	1	1	/	/	/	/	/	/	/	1	1	2	1	1	/	/	/	/	/	/	/
	13A Single Socket Outlet 13安培單位電插座	1	1	1	1	1	/	/	/	/	/	/	/	1	1	1	1	1	/	/	/	/	/	/	/
	TV / FM Outlet 電視 / 電台天線插座	1	1	1	1	1	/	/	/	/	/	/	/	1	1	1	1	1	/	/	/	/	/	/	/
	Standby Data Box With Blank Cover 後備數據盒連蓋板	1	1	1	1	1	/	/	/	/	/	/	/	1	1	1	1	1	/	/	/	/	/	/	/
	Switch for Air-conditioner Indoor Unit 室內空調機開關掣	1	1	1	1	1	/	/	/	/	/	/	/	1	1	1	1	1	/	/	/	/	/	/	/
	13A Twin Socket Outlet With USB 13安培雙位電插座連 USB	1	1	1	1	1	/	/	/	/	/	/	/	1	1	1	1	1	/	/	/	/	/	/	/
	Double Pole Switch 雙極開關掣	/	/	2	/	/	/	/	/	/	/	/	/	/	/	2	/	/	/	/	/	/	/	/	/
Master Bathroom 主人浴室	Lighting Point 燈位	/	/	3	/	/	/	/	/	/	/	/	/	/	3	/	/	/	/	/	/	/	/	/	
	Switch with Connection Unit for Thermo Ventilator 浴室寶開關掣連接線位	/	/	1	/	/	/	/	/	/	/	/	/	/	1	/	/	/	/	/	/	/	/	/	
	32A TPN Weatherproof Switch for Electric Water Heater 防水32A 三相電熱水爐開關掣連接線位	/	/	1	/	/	/	/	/	/	/	/	/	/	1	/	/	/	/	/	/	/	/	/	
	13A Twin Socket Outlet With USB 13安培雙位電插座連 USB	/	/	1	/	/	/	/	/	/	/	/	/	/	1	/	/	/	/	/	/	/	/	/	
Balcony and Utility Room 露台及工作平台	Lighting Point 燈位	/	1	/	1	1	1	1	1	/	/	/	1	/	1	/	1	1	1	1	1	/	/	1	
	Gas Meter 煤氣錶	/	1	/	1	1	1	1	1	/	/	/	1	/	1	/	1	1	1	1	1	/	/	1	
Balcony 露台	Lighting Point 燈位	1	/	1	/	/	/	/	/	1	1	1	/	1	/	1	/	/	/	/	/	1	1	1	
	Gas Meter 煤氣錶	1	/	1	/	/	/	/	/	-	-	-	/	1	/	1	/	/	/	/	/	-	-	-	
Utility Room 工作平台	Lighting Point 燈位	1	/	1	/	/	/	/	/	/	/	/	1	/	1	/	/	/	/	/	/	/	/	/	
Air-conditioner Platform 冷氣機平台	Switch for Air-conditioner Outdoor Unit 冷氣機室外機開關掣	2	1	2	1	1	1	1	1	1	1	1	2	1	2	1	1	1	1	1	1	1	1	1	

## Notes:

- “1, 2, ……” as shown in the above table denotes the quantity of such provision(s) provided in the residential property.
- The symbol “-” as shown in the above table denotes “Not Provided”.
- The symbol “/” as shown in the above table denotes “Not Applicable”.
- 4/F, 13/F, 14/F and 24/F are omitted.

## 備註:

- 上表「1, 2, ……」表示提供於該住宅物業內的裝置數量。
- 上表“-”代表「不提供」。
- 上表“/”代表「不適用」。
- 不設4樓、13樓、14樓及24樓。

Schedule of Electrical &amp; Mechanical Provisions of Residential Units 住宅單位機電裝置數量說明表

Location 位置	Appliances 設備	Tower 5 (5A) 第5座 (5A) Floor and Unit 樓層及單位 10/F - 12/F, 15/F - 23/F & 25/F 10樓至12樓、15樓至23樓及25樓												Tower 5 (5A) 第5座 (5A) Floor and Unit 樓層及單位 26/F 26樓												
		A	B	C	D	E	F	G	H	J	K	M	N	P	A	B	C	D	E	F	G	H	J	K	M	N
Main Entrance 大門入口	Door Bell Button 門鈴按鈕	1	1	1	1	1	1	1	1	1	1	1	1	1	1	1	1	1	1	1	1	1	1	1	1	
Living Room and Dining Room 客廳及飯廳	Lighting Point 燈位	4	3	5	4	4	2	2	2	2	3	3	3	2	4	3	5	4	4	2	2	2	3	3	3	2
	Lighting Switch 燈掣	6	4	6	4	5	4	4	4	4	5	5	5	4	6	4	6	4	5	4	4	4	4	5	5	4
	13A Single Socket Outlet 13安培單位電插座	2	-	2	1	-	-	-	-	-	-	-	-	1	2	-	2	1	-	-	-	-	-	-	-	1
	13A Twin Socket Outlet 13安培雙位電插座	2	2	2	2	2	2	2	2	2	2	2	2	2	2	2	2	2	2	2	2	2	2	2	2	2
	Telephone Outlet 電話插座	1	1	2	1	1	1	1	1	1	1	1	1	1	1	1	2	1	1	1	1	1	1	1	1	1
	TV / FM Outlet 電視 / 電台天線插座	1	1	2	1	1	1	1	1	1	1	1	1	1	1	1	2	1	1	1	1	1	1	1	1	1
	Incoming Data Box With Blank Cover 總數據插座連蓋板	1	1	1	1	1	1	1	1	1	1	1	1	1	1	1	1	1	1	1	1	1	1	1	1	1
	Standby Data Box With Blank Cover 後備數據盒連蓋板	-	-	1	-	-	-	-	-	-	-	-	-	-	-	-	1	-	-	-	-	-	-	-	-	-
	Switch for Air-conditioner Indoor Unit 冷氣機室內機開關掣	1	1	1	1	1	1	1	1	1	1	1	1	1	1	1	1	1	1	1	1	1	1	1	1	1
	Video Door Phone 視像對講機	1	1	1	1	1	1	1	1	1	1	1	1	1	1	1	1	1	1	1	1	1	1	1	1	1
	13A Single Socket Outlet With USB 13安培單位電插座連 USB	1	1	1	1	1	1	1	1	1	1	1	1	1	1	1	1	1	1	1	1	1	1	1	1	1
	13A Twin Socket Outlet With USB 13安培雙位電插座連 USB	-	-	1	-	-	-	-	-	-	-	-	-	-	-	-	1	-	-	-	-	-	-	-	-	-
	Miniature Circuit Breakers Board 總電掣箱	1	1	1	-	1	1	1	1	1	-	-	-	-	1	1	1	-	1	1	1	1	-	-	-	-
	Door Bell With Connection Unit 門鈴連接線位	1	1	1	1	1	1	1	-	-	1	1	1	1	1	1	1	1	1	1	1	-	-	1	1	1
	Switch with Connection Unit for Steam Oven with Microwave 微波蒸烤焗爐開關掣連接線位	-	-	-	-	-	-	-	-	-	-	-	-	1	-	-	-	-	-	-	-	-	-	-	-	1
	Switch with Connection Unit for Exhaust Fan 抽氣扇開關掣連接線位	-	-	1	1	-	-	-	-	-	-	-	-	-	-	-	1	1	-	-	-	-	-	-	-	-
Double Pole Switch 雙極開關掣	3	3	4	3	3	3	3	3	3	3	3	3	3	3	3	4	3	3	3	3	3	3	3	3	3	
Smoke Detector 煙霧探測器	1	1	-	1	1	1	1	1	1	1	1	1	1	1	1	-	1	1	1	1	1	1	1	1	1	

## Notes:

- "1, 2, ....." as shown in the above table denotes the quantity of such provision(s) provided in the residential property.
- The symbol "-" as shown in the above table denotes "Not Provided".
- The symbol "/" as shown in the above table denotes "Not Applicable".
- 4/F, 13/F, 14/F and 24/F are omitted.

## 備註:

- 上表「1, 2, .....
- 上表“-”代表「不提供」。
- 上表“/”代表「不適用」。
- 不設4樓、13樓、14樓及24樓。

Schedule of Electrical &amp; Mechanical Provisions of Residential Units 住宅單位機電裝置數量說明表

Location 位置	Appliances 設備	Tower 5 (5A) 第5座 (5A) Floor and Unit 樓層及單位 10/F - 12/F, 15/F - 23/F & 25/F 10樓至12樓、15樓至23樓及25樓												Tower 5 (5A) 第5座 (5A) Floor and Unit 樓層及單位 26/F 26樓											
		A	B	C	D	E	F	G	H	J	K	M	N	P	A	B	C	D	E	F	G	H	J	K	M
Kitchen or Open Kitchen 廚房或開放式廚房	Lighting Point 燈位	-	-	3	-	-	-	-	-	-	-	-	-	-	-	-	3	-	-	-	-	-	-	-	-
	Lighting Switch 燈掣	-	-	-	-	1	-	-	-	-	-	-	-	-	-	-	-	-	1	-	-	-	-	-	-
	13A Single Socket Outlet 13安培單位電插座	1	3	6	2	3	4	4	4	4	3	3	3	3	1	3	6	2	3	4	4	4	3	3	3
	13A Twin Socket Outlet 13安培雙位電插座	1	1	1	1	1	-	-	-	-	-	-	-	-	1	1	1	1	1	-	-	-	-	-	-
	Connection Unit for Electric Water Heater 電熱水爐接線位	1	1	1	1	1	1	1	1	1	1	1	1	1	1	1	1	1	1	1	1	1	1	1	1
	Switch with Connection Unit for Exhaust Fan 抽氣扇開關掣連接線位	-	-	1	-	-	-	-	-	-	-	-	-	-	-	-	1	-	-	-	-	-	-	-	-
	13A Twin Socket Outlet With USB 13安培雙位電插座連 USB	1	1	1	1	1	1	1	1	1	1	1	1	1	1	1	1	1	1	1	1	1	1	1	1
	Switch with Connection Unit for Steam Oven with Microwave 微波蒸烤焗爐開關掣連接線位	1	1	1	1	1	1	1	1	1	1	1	1	-	1	1	1	1	1	1	1	1	1	1	-
	Connection Unit for Electric Induction Hob 供電磁煮食爐接駁點	-	-	-	-	-	-	-	-	-	1	1	1	-	-	-	-	-	-	-	-	-	1	1	-
	Towngas Connection Point 煤氣接駁點	1	1	1	1	1	1	1	1	1	-	-	-	1	1	1	1	1	1	1	1	1	-	-	1
	Washing Machine Water Supply 洗衣機來水位	1	1	1	1	1	1	1	1	1	1	1	1	1	1	1	1	1	1	1	1	1	1	1	1
	Washing Machine Drain 洗衣機去水位	1	1	1	1	1	1	1	1	1	1	1	1	1	1	1	1	1	1	1	1	1	1	1	1
	Fire Service Sprinkler Head 消防花灑頭	3	3	-	4	4	4	4	4	4	3	3	4	3	3	3	-	4	4	4	4	4	3	3	4
	Miniature Circuit Breakers Board 總電掣箱	-	-	-	1	-	-	-	-	-	1	1	1	1	-	-	-	1	-	-	-	-	1	1	1
Door Bell Connection Unit 門鈴接線位	-	-	-	-	-	-	-	1	1	-	-	-	-	-	-	-	-	-	-	1	1	-	-	-	
Bathroom 浴室	Lighting Point 燈位	3	3	3	3	3	3	3	3	3	3	3	3	3	3	3	3	3	3	3	3	3	3	3	
	Switch with Connection Unit for Exhaust Fan 抽氣扇開關掣連接線位	-	1	-	-	1	1	1	1	1	1	1	1	-	1	-	-	1	1	1	1	1	1	1	
	Switch with Connection Unit for Thermo Ventilator 浴室實開關掣連接線位	1	1	1	1	1	1	1	1	1	1	1	1	1	1	1	1	1	1	1	1	1	1	1	
	32A TPN Weatherproof Switch for Electric Water Heater 防水32A 三相電熱水爐開關掣連接線位	1	1	1	1	1	1	1	1	1	1	1	1	1	1	1	1	1	1	1	1	1	1	1	
	13A Twin Socket Outlet With USB 13安培雙位電插座連 USB	1	1	1	1	1	1	1	1	1	1	1	1	1	1	1	1	1	1	1	1	1	1	1	

## Notes:

- "1, 2, ....." as shown in the above table denotes the quantity of such provision(s) provided in the residential property.
- The symbol "-" as shown in the above table denotes "Not Provided".
- The symbol "/" as shown in the above table denotes "Not Applicable".
- 4/F, 13/F, 14/F and 24/F are omitted.

## 備註:

- 上表「1, 2, .....
- 上表「-」代表「不提供」。
- 上表「/」代表「不適用」。
- 不設4樓、13樓、14樓及24樓。



Schedule of Electrical &amp; Mechanical Provisions of Residential Units 住宅單位機電裝置數量說明表

Location 位置	Appliances 設備	Tower 5 (5A) 第5座 (5A) Floor and Unit 樓層及單位 10/F - 12/F, 15/F - 23/F & 25/F 10樓至12樓、15樓至23樓及25樓												Tower 5 (5A) 第5座 (5A) Floor and Unit 樓層及單位 26/F 26樓											
		A	B	C	D	E	F	G	H	J	K	M	N	P	A	B	C	D	E	F	G	H	J	K	M
Store Room 2 儲物室2	Lighting Point 燈位	1	/	1	/	/	/	/	/	/	/	/	/	1	/	1	/	/	/	/	/	/	/	/	/
	Lighting Switch 燈掣	1	/	1	/	/	/	/	/	/	/	/	/	1	/	1	/	/	/	/	/	/	/	/	/
	Switch for Air-conditioner Indoor Unit 冷氣機室內機開關掣	1	/	1	/	/	/	/	/	/	/	/	/	1	/	1	/	/	/	/	/	/	/	/	/
Walk-In Closet 衣帽間	Lighting Point 燈位	/	/	/	/	/	1	1	/	/	/	/	/	/	/	/	/	1	1	/	/	/	/	/	
	Lighting Switch 燈掣	/	/	/	/	/	1	1	/	/	/	/	/	/	/	/	/	1	1	/	/	/	/	/	
	Switch for Air-conditioner Indoor Unit 冷氣機室內機開關掣	/	/	/	/	/	1	1	/	/	/	/	/	/	/	/	/	1	1	/	/	/	/	/	
Bedroom or Bedroom 1 睡房或睡房1	Lighting Point 燈位	1	1	1	1	1	1	1	1	1	/	/	/	1	1	1	1	1	1	1	1	1	/	/	1
	Lighting Switch 燈掣	1	1	1	1	1	1	1	1	1	/	/	/	1	1	1	1	1	1	1	1	1	/	/	1
	13A Single Socket Outlet 13安培單位電插座	1	1	1	1	1	1	1	1	1	/	/	/	1	1	1	1	1	1	1	1	1	/	/	1
	TV / FM Outlet 電視 / 電台天線插座	1	1	1	1	1	1	1	1	1	/	/	/	1	1	1	1	1	1	1	1	1	/	/	1
	Standby Data Box With Blank Cover 後備數據盒連蓋板	1	1	1	1	1	1	1	1	1	/	/	/	1	1	1	1	1	1	1	1	1	/	/	1
	Switch for Air-conditioner Indoor Unit 冷氣機室內機開關掣	1	1	1	1	1	1	1	1	1	/	/	/	1	1	1	1	1	1	1	1	1	/	/	1
	13A Twin Socket Outlet With USB 13安培雙位電插座連USB	1	1	1	1	1	1	1	1	1	/	/	/	1	1	1	1	1	1	1	1	1	/	/	1
Bedroom 2 睡房2	Lighting Point 燈位	/	/	1	/	/	/	/	/	/	/	/	/	/	/	1	/	/	/	/	/	/	/	/	
	Lighting Switch 燈掣	/	/	1	/	/	/	/	/	/	/	/	/	/	/	1	/	/	/	/	/	/	/	/	
	13A Single Socket Outlet 13安培單位電插座	/	/	1	/	/	/	/	/	/	/	/	/	/	/	1	/	/	/	/	/	/	/	/	
	TV / FM Outlet 電視 / 電台天線插座	/	/	1	/	/	/	/	/	/	/	/	/	/	/	1	/	/	/	/	/	/	/	/	
	Standby Data Box With Blank Cover 後備數據盒連蓋板	/	/	1	/	/	/	/	/	/	/	/	/	/	/	1	/	/	/	/	/	/	/	/	
	Switch for Air-conditioner Indoor Unit 冷氣機室內機開關掣	/	/	1	/	/	/	/	/	/	/	/	/	/	/	1	/	/	/	/	/	/	/	/	
	13A Twin Socket Outlet With USB 13安培雙位電插座連USB	/	/	1	/	/	/	/	/	/	/	/	/	/	/	1	/	/	/	/	/	/	/	/	

## Notes:

- "1, 2, ....." as shown in the above table denotes the quantity of such provision(s) provided in the residential property.
- The symbol "-" as shown in the above table denotes "Not Provided".
- The symbol "/" as shown in the above table denotes "Not Applicable".
- 4/F, 13/F, 14/F and 24/F are omitted.

## 備註:

- 上表「1, 2, .....
- 上表“-”代表「不提供」。
- 上表“/”代表「不適用」。
- 不設4樓、13樓、14樓及24樓。

Schedule of Electrical &amp; Mechanical Provisions of Residential Units 住宅單位機電裝置數量說明表

Location 位置	Appliances 設備	Tower 5 (5A) 第5座 (5A) Floor and Unit 樓層及單位 10/F - 12/F, 15/F - 23/F & 25/F 10樓至12樓、15樓至23樓及25樓												Tower 5 (5A) 第5座 (5A) Floor and Unit 樓層及單位 26/F 26樓												
		A	B	C	D	E	F	G	H	J	K	M	N	P	A	B	C	D	E	F	G	H	J	K	M	N
Master Bedroom 主人睡房	Lighting Point 燈位	1	1	1	1	1	/	/	/	/	/	/	/	/	1	1	1	1	1	/	/	/	/	/	/	/
	Lighting Switch 燈掣	1	1	2	1	1	/	/	/	/	/	/	/	/	1	1	2	1	1	/	/	/	/	/	/	/
	13A Single Socket Outlet 13安培單位電插座	1	1	1	1	1	/	/	/	/	/	/	/	/	1	1	1	1	1	/	/	/	/	/	/	/
	TV / FM Outlet 電視 / 電台天線插座	1	1	1	1	1	/	/	/	/	/	/	/	/	1	1	1	1	1	/	/	/	/	/	/	/
	Standby Data Box With Blank Cover 後備數據盒連蓋板	1	1	1	1	1	/	/	/	/	/	/	/	/	1	1	1	1	1	/	/	/	/	/	/	/
	Switch for Air-conditioner Indoor Unit 室內空調機開關掣	1	1	1	1	1	/	/	/	/	/	/	/	/	1	1	1	1	1	/	/	/	/	/	/	/
	13A Twin Socket Outlet With USB 13安培雙位電插座連USB	1	1	1	1	1	/	/	/	/	/	/	/	/	1	1	1	1	1	/	/	/	/	/	/	/
	Double Pole Switch 雙極開關掣	/	/	2	/	/	/	/	/	/	/	/	/	/	/	/	2	/	/	/	/	/	/	/	/	/
Master Bathroom 主人浴室	Lighting Point 燈位	/	/	3	/	/	/	/	/	/	/	/	/	/	/	3	/	/	/	/	/	/	/	/	/	
	Switch with Connection Unit for Thermo Ventilator 浴室寶開關掣連接線位	/	/	1	/	/	/	/	/	/	/	/	/	/	/	1	/	/	/	/	/	/	/	/	/	
	32A TPN Weatherproof Switch for Electric Water Heater 防水32A 三相電熱水爐開關掣連接線位	/	/	1	/	/	/	/	/	/	/	/	/	/	/	1	/	/	/	/	/	/	/	/	/	
	13A Twin Socket Outlet With USB 13安培雙位電插座連USB	/	/	1	/	/	/	/	/	/	/	/	/	/	/	1	/	/	/	/	/	/	/	/	/	
Balcony & Utility Room 露台及工作平台	Lighting Point 燈位	/	1	/	1	1	1	1	1	/	/	/	1	/	1	/	1	1	1	1	1	1	/	/	1	
	Gas Meter 煤氣錶	/	1	/	1	1	1	1	1	/	/	/	1	/	1	/	1	1	1	1	1	1	/	/	1	
Balcony 露台	Lighting Point 燈位	1	/	1	/	/	/	/	/	1	1	1	/	1	/	1	/	/	/	/	/	1	1	1	/	
	Gas Meter 煤氣錶	1	/	1	/	/	/	/	/	-	-	-	/	1	/	1	/	/	/	/	/	-	-	-	/	
Utility Room 工作平台	Lighting Point 燈位	1	/	1	/	/	/	/	/	/	/	/	/	1	/	1	/	/	/	/	/	/	/	/	/	
Air-conditioner Platform 冷氣機平台	Switch for Air-conditioner Outdoor Unit 冷氣機室外機開關掣	2	1	2	1	1	1	1	1	1	1	1	1	2	1	2	1	1	1	1	1	1	1	1	1	
Roof 天台	Lighting Point 燈位	/	/	/	/	/	/	/	/	/	/	/	/	7	6	8	8	5	5	5	2	3	3	3	6	7
	13A Waterproof Single Socket Outlet 13安培單位防水電插座	/	/	/	/	/	/	/	/	/	/	/	/	1	1	1	1	1	1	1	1	1	1	1	1	
	Waterproof Lighting Switch 防水燈掣	/	/	/	/	/	/	/	/	/	/	/	/	1	1	1	1	1	1	1	1	1	1	1	1	

## Notes:

- "1, 2, ....." as shown in the above table denotes the quantity of such provision(s) provided in the residential property.
- The symbol "-" as shown in the above table denotes "Not Provided".
- The symbol "/" as shown in the above table denotes "Not Applicable".
- 4/F, 13/F, 14/F and 24/F are omitted.

## 備註:

- 上表「1, 2, .....
- 上表“-”代表「不提供」。
- 上表“/”代表「不適用」。
- 不設4樓、13樓、14樓及24樓。

Schedule of Electrical &amp; Mechanical Provisions of Residential Units 住宅單位機電裝置數量說明表

Location 位置	Appliances 設備	Tower 5 (5B) 第5座(5B) Floor and Unit 樓層及單位 7/F 7樓						Tower 5 (5B) 第5座(5B) Floor and Unit 樓層及單位 8/F 8樓						Tower 5 (5B) 第5座(5B) Floor and Unit 樓層及單位 9/F 9樓													
		A	B	C	J	K	M	N	A	B	C	J	K	M	N	A	B	C	D	E	F	G	H	J	K	M	N
Main Entrance 大門入口	Door Bell Button 門鈴按鈕	1	1	1	1	1	1	1	1	1	1	1	1	1	1	1	1	1	1	1	1	1	1	1	1	1	
Living Room and Dining Room 客廳及飯廳	Lighting Point 燈位	2	2	3	3	3	2	2	2	2	3	3	3	2	2	2	2	3	3	3	3	4	3	3	3	2	2
	Lighting Switch 燈掣	4	4	5	5	5	4	4	4	4	5	5	5	4	4	4	4	5	5	5	4	4	5	5	5	4	4
	13A Single Socket Outlet 13安培單位電插座	1	1	-	-	-	-	-	1	1	-	-	-	-	-	1	1	-	-	-	1	1	-	-	-	-	-
	13A Twin Socket Outlet 13安培雙位電插座	2	2	2	2	2	2	2	2	2	2	2	2	2	2	2	2	2	2	2	2	1	2	2	2	2	2
	Telephone Outlet 電話插座	1	1	1	1	1	1	1	1	1	1	1	1	1	1	1	1	1	1	1	1	1	1	1	1	1	1
	TV / FM Outlet 電視 / 電台天線插座	1	1	1	1	1	1	1	1	1	1	1	1	1	1	1	1	1	1	1	2	2	1	1	1	1	1
	Incoming Data Box With Blank Cover 總數據插座連蓋板	1	1	1	1	1	1	1	1	1	1	1	1	1	1	1	1	1	1	1	1	1	1	1	1	1	1
	Standby Data Box With Blank Cover 後備數據盒連蓋板	-	-	-	-	-	-	-	-	-	-	-	-	-	-	-	-	-	-	-	1	1	-	-	-	-	-
	Switch for Air-conditioner Indoor Unit 冷氣機室內機開關掣	1	1	1	1	1	1	1	1	1	1	1	1	1	1	1	1	1	1	1	2	2	1	1	1	1	1
	Video Door Phone 視像對講機	1	1	1	1	1	1	1	1	1	1	1	1	1	1	1	1	1	1	1	1	1	1	1	1	1	1
	13A Single Socket Outlet With USB 13安培單位電插座連 USB	1	1	1	1	1	1	1	1	1	1	1	1	1	1	1	1	1	1	1	1	1	1	1	1	1	1
	Miniature Circuit Breakers Board 總電掣箱	-	-	-	-	-	1	1	-	-	-	-	-	1	1	-	-	-	1	-	-	1	-	-	-	1	1
	Door Bell With Connection Unit 門鈴連接線位	1	1	1	1	1	1	1	1	1	1	1	1	1	1	1	1	1	1	1	1	1	1	1	1	1	1
	Double Pole Switch 雙極開關掣	3	3	3	3	3	3	3	3	3	3	3	3	3	3	3	3	3	3	3	3	3	3	3	3	3	3
Smoke Detector 煙霧探測器	1	1	1	1	1	1	1	1	1	1	1	1	1	1	1	1	1	1	1	1	1	1	1	1	1	1	

## Notes:

- “1, 2, ……” as shown in the above table denotes the quantity of such provision(s) provided in the residential property.
- The symbol “-” as shown in the above table denotes “Not Provided”.
- The symbol “/” as shown in the above table denotes “Not Applicable”.
- 4/F, 13/F, 14/F and 24/F are omitted.

## 備註:

- 上表「1, 2, ……」表示提供於該住宅物業內的裝置數量。
- 上表“-”代表「不提供」。
- 上表“/”代表「不適用」。
- 不設4樓、13樓、14樓及24樓。

Schedule of Electrical &amp; Mechanical Provisions of Residential Units 住宅單位機電裝置數量說明表

Location 位置	Appliances 設備	Tower 5 (5B) 第5座(5B) Floor and Unit 樓層及單位 7/F 7樓							Tower 5 (5B) 第5座(5B) Floor and Unit 樓層及單位 8/F 8樓							Tower 5 (5B) 第5座(5B) Floor and Unit 樓層及單位 9/F 9樓											
		A	B	C	J	K	M	N	A	B	C	J	K	M	N	A	B	C	D	E	F	G	H	J	K	M	N
Kitchen or Open Kitchen 廚房或開放式廚房	13A Single Socket Outlet 13安培單位電插座	3	3	3	3	3	4	4	3	3	3	3	3	4	4	3	3	3	3	3	4	3	3	3	4	4	
	Connection Unit for Electric Water Heater 電熱水爐接線位	1	1	1	1	1	1	1	1	1	1	1	1	1	1	1	1	1	1	1	1	1	1	1	1	1	
	13A Twin Socket Outlet With USB 13安培雙位電插座連 USB	1	1	1	1	1	1	1	1	1	1	1	1	1	1	1	1	1	1	1	1	1	1	1	1	1	
	Switch with Connection Unit for Steam Oven with Microwave 微波蒸烤焗爐開關掣連接線位	-	-	1	1	1	1	1	-	-	1	1	1	1	1	-	-	1	1	1	-	1	1	1	1	1	
	Connection Unit for Electric Induction Hob 供電磁煮食爐接駁點	-	-	1	1	1	-	-	-	-	1	1	1	-	-	-	-	1	1	1	-	-	1	1	1	-	-
	Towngas Connection Point 煤氣接駁點	1	1	-	-	-	1	1	1	1	-	-	-	1	1	1	1	-	-	-	1	1	-	-	-	1	1
	Washing Machine Water Supply 洗衣機來水位	1	1	1	1	1	1	1	1	1	1	1	1	1	1	1	1	1	1	1	1	1	1	1	1	1	
	Washing Machine Drain 洗衣機去水位	1	1	1	1	1	1	1	1	1	1	1	1	1	1	1	1	1	1	1	1	1	1	1	1	1	
	Fire Service Sprinkler Head 消防花灑頭	3	4	3	3	3	4	4	3	4	3	3	3	4	4	3	4	3	3	3	2	3	3	3	3	4	4
Miniature Circuit Breakers Board 總電掣箱	1	1	1	1	1	-	-	1	1	1	1	1	-	-	1	1	1	-	1	1	-	1	1	1	-	-	
Bathroom 浴室	Lighting Point 燈位	3	3	3	3	3	3	3	3	3	3	3	3	3	3	3	3	3	3	3	3	3	3	3	3	3	
	Switch with Connection Unit for Exhaust Fan 抽氣扇開關掣連接線位	1	1	1	1	1	1	1	1	1	1	1	1	1	1	1	1	1	1	1	1	1	1	1	1	1	
	Switch with Connection Unit for Thermo Ventilator 浴室寶開關掣連接線位	1	1	1	1	1	1	1	1	1	1	1	1	1	1	1	1	1	1	1	1	1	1	1	1	1	
	32A TPN Weatherproof Switch for Electric Water Heater 防水32A 三相電熱水爐開關掣連接線位	1	1	1	1	1	1	1	1	1	1	1	1	1	1	1	1	1	1	1	1	1	1	1	1	1	
	13A Twin Socket Outlet With USB 13安培雙位電插座連 USB	1	1	1	1	1	1	1	1	1	1	1	1	1	1	1	1	1	1	1	1	1	1	1	1	1	

## Notes:

- "1, 2, ....." as shown in the above table denotes the quantity of such provision(s) provided in the residential property.
- The symbol "-" as shown in the above table denotes "Not Provided".
- The symbol "/" as shown in the above table denotes "Not Applicable".
- 4/F, 13/F, 14/F and 24/F are omitted.

## 備註:

- 上表「1, 2, ....."表示提供於該住宅物業內的裝置數量。
- 上表“-”代表「不提供」。
- 上表“/”代表「不適用」。
- 不設4樓、13樓、14樓及24樓。

Schedule of Electrical &amp; Mechanical Provisions of Residential Units 住宅單位機電裝置數量說明表

Location 位置	Appliances 設備	Tower 5 (5B) 第5座(5B) Floor and Unit 樓層及單位 7/F 7樓							Tower 5 (5B) 第5座(5B) Floor and Unit 樓層及單位 8/F 8樓							Tower 5 (5B) 第5座(5B) Floor and Unit 樓層及單位 9/F 9樓											
		A	B	C	J	K	M	N	A	B	C	J	K	M	N	A	B	C	D	E	F	G	H	J	K	M	N
Bedroom 睡房	Lighting Point 燈位	1	1	/	/	/	1	1	1	1	/	/	/	1	1	1	1	/	/	/	/	/	/	/	/	1	1
	Lighting Switch 燈掣	1	1	/	/	/	1	1	1	1	/	/	/	1	1	1	1	/	/	/	/	/	/	/	/	1	1
	13A Single Socket Outlet 13安培單位電插座	1	1	/	/	/	1	1	1	1	/	/	/	1	1	1	1	/	/	/	/	/	/	/	/	1	1
	TV / FM Outlet 電視 / 電台天線插座	1	1	/	/	/	1	1	1	1	/	/	/	1	1	1	1	/	/	/	/	/	/	/	/	1	1
	Standby Data Box With Blank Cover 後備數據盒連蓋板	1	1	/	/	/	1	1	1	1	/	/	/	1	1	1	1	/	/	/	/	/	/	/	/	1	1
	Switch for Air-conditioner Indoor Unit 冷氣機室內機開關掣	1	1	/	/	/	1	1	1	1	/	/	/	1	1	1	1	/	/	/	/	/	/	/	/	1	1
	13A Twin Socket Outlet With USB 13安培雙位電插座連USB	1	1	/	/	/	1	1	1	1	/	/	/	1	1	1	1	/	/	/	/	/	/	/	/	1	1
Balcony and Utility Room 露台及工作平台	Lighting Point 燈位	1	1	/	/	/	1	/	1	1	/	/	/	1	1	1	1	/	/	/	1	/	/	/	1	1	
	Gas Meter 煤氣錶	1	1	/	/	/	1	/	1	1	/	/	/	1	1	1	1	/	/	/	1	/	/	/	1	1	
Balcony 露台	Lighting Point 燈位	/	/	1	/	/	/	/	/	/	1	1	1	/	/	/	/	1	/	/	/	/	1	1	/	/	
Air-conditioner Platform 冷氣機平台	Switch for Air-conditioner Outdoor Unit 冷氣機室外機開關掣	1	1	1	/	/	1	/	1	1	1	1	1	1	1	1	1	/	/	1	/	/	1	1	1	1	
Flat Roof 平台	Lighting Point 燈位	/	/	/	3	3	/	2	/	/	/	/	/	/	/	/	/	3	3	5	3	2	/	/	/	/	
	13A Waterproof Single Socket Outlet 13安培單位防水電插座	/	/	/	1	1	/	1	/	/	/	/	/	/	/	/	/	1	1	1	1	1	/	/	/	/	
	Switch for Air-conditioner Outdoor Unit 冷氣機室外機開關掣	/	/	/	1	1	/	1	/	/	/	/	/	/	/	/	/	-	-	-	1	-	/	/	/	/	
	Gas Meter 煤氣錶	/	/	/	-	-	/	1	/	/	/	/	/	/	/	/	/	-	-	-	1	-	/	/	/	/	
Inaccessible Common Flat Roof 維修平台	Switch for Air-conditioner Outdoor Unit 冷氣機室外機開關掣	/	/	/	/	/	/	/	/	/	/	/	/	/	/	/	/	1	1	/	/	1	/	/	/	/	

## Notes:

- “1, 2, ……” as shown in the above table denotes the quantity of such provision(s) provided in the residential property.
- The symbol “-” as shown in the above table denotes “Not Provided”.
- The symbol “/” as shown in the above table denotes “Not Applicable”.
- 4/F, 13/F, 14/F and 24/F are omitted.

## 備註:

- 上表「1, 2, ……」表示提供於該住宅物業內的裝置數量。
- 上表“-”代表「不提供」。
- 上表“/”代表「不適用」。
- 不設4樓、13樓、14樓及24樓。

Schedule of Electrical &amp; Mechanical Provisions of Residential Units 住宅單位機電裝置數量說明表

Location 位置	Appliances 設備	Tower 5 (5B) 第5座(5B) Floor and Unit 樓層及單位 10/F - 12/F, 15/F - 23/F & 25/F 10樓至12樓、15樓至23樓及25樓												Tower 5 (5B) 第5座(5B) Floor and Unit 樓層及單位 26/F 26樓											
		A	B	C	D	E	F	G	H	J	K	M	N	A	B	C	D	E	F	G	H	J	K	M	N
Main Entrance 大門入口	Door Bell Button 門鈴按鈕	1	1	1	1	1	1	1	1	1	1	1	1	1	1	1	1	1	1	1	1	1	1		
Living Room and Dining Room 客廳及飯廳	Lighting Point 燈位	2	2	3	3	3	3	4	3	3	3	2	2	2	2	3	3	3	3	4	3	3	3	2	2
	Lighting Switch 燈掣	4	4	5	5	5	4	4	5	5	5	4	4	4	4	5	5	5	4	4	5	5	5	4	4
	13A Single Socket Outlet 13安培單位電插座	1	1	-	-	-	1	1	-	-	-	-	-	1	1	-	-	-	1	1	-	-	-	-	-
	13A Twin Socket Outlet 13安培雙位電插座	2	2	2	2	2	2	1	2	2	2	2	2	2	2	2	2	2	1	2	2	2	2	2	2
	Telephone Outlet 電話插座	1	1	1	1	1	1	1	1	1	1	1	1	1	1	1	1	1	1	1	1	1	1	1	1
	TV / FM Outlet 電視 / 電台天線插座	1	1	1	1	1	2	2	1	1	1	1	1	1	1	1	1	1	2	2	1	1	1	1	1
	Incoming Data Box With Blank Cover 總數據插座連蓋板	1	1	1	1	1	1	1	1	1	1	1	1	1	1	1	1	1	1	1	1	1	1	1	1
	Standby Data Box With Blank Cover 後備數據盒連蓋板	-	-	-	-	-	1	1	-	-	-	-	-	-	-	-	-	-	1	1	-	-	-	-	-
	Switch for Air-conditioner Indoor Unit 冷氣機室內機開關掣	1	1	1	1	1	2	2	1	1	1	1	1	1	1	1	1	1	2	2	1	1	1	1	1
	Video Door Phone 視像對講機	1	1	1	1	1	1	1	1	1	1	1	1	1	1	1	1	1	1	1	1	1	1	1	1
	13A Single Socket Outlet With USB 13安培單位電插座連USB	1	1	1	1	1	1	1	1	1	1	1	1	1	1	1	1	1	1	1	1	1	1	1	1
	Miniature Circuit Breakers Board 總電掣箱	-	-	-	1	-	-	1	-	-	-	1	1	-	-	-	1	-	-	1	-	-	-	1	1
	Door Bell With Connection Unit 門鈴連接線位	1	1	1	1	1	1	1	1	1	1	1	1	1	1	1	1	1	1	1	1	1	1	1	1
	Double Pole Switch 雙極開關掣	3	3	3	3	3	3	3	3	3	3	3	3	3	3	3	3	3	3	3	3	3	3	3	3
Smoke Detector 煙霧探測器	1	1	1	1	1	1	1	1	1	1	1	1	1	1	1	1	1	1	1	1	1	1	1	1	

## Notes:

- "1, 2, ....." as shown in the above table denotes the quantity of such provision(s) provided in the residential property.
- The symbol "-" as shown in the above table denotes "Not Provided".
- The symbol "/" as shown in the above table denotes "Not Applicable".
- 4/F, 13/F, 14/F and 24/F are omitted.

## 備註:

- 上表「1, 2, ....."表示提供於該住宅物業內的裝置數量。
- 上表“-”代表「不提供」。
- 上表“/”代表「不適用」。
- 不設4樓、13樓、14樓及24樓。

Schedule of Electrical &amp; Mechanical Provisions of Residential Units 住宅單位機電裝置數量說明表

Location 位置	Appliances 設備	Tower 5 (5B) 第5座(5B) Floor and Unit 樓層及單位 10/F - 12/F, 15/F - 23/F & 25/F 10樓至12樓、15樓至23樓及25樓												Tower 5 (5B) 第5座(5B) Floor and Unit 樓層及單位 26/F 26樓											
		A	B	C	D	E	F	G	H	J	K	M	N	A	B	C	D	E	F	G	H	J	K	M	N
Kitchen or Open Kitchen 廚房或開放式廚房	13A Single Socket Outlet 13安培單位電插座	3	3	3	3	3	3	4	3	3	3	4	4	3	3	3	3	3	4	3	3	3	4	4	
	Connection Unit for Electric Water Heater 電熱水爐接線位	1	1	1	1	1	1	1	1	1	1	1	1	1	1	1	1	1	1	1	1	1	1	1	
	13A Twin Socket Outlet With USB 13安培雙位電插座連USB	1	1	1	1	1	1	1	1	1	1	1	1	1	1	1	1	1	1	1	1	1	1	1	
	Switch with Connection Unit for Steam Oven with Microwave 微波蒸烤焗爐開關掣連接線位	-	-	1	1	1	-	1	1	1	1	1	1	-	-	1	1	1	-	1	1	1	1	1	
	Connection Unit for Electric Induction Hob 供電磁煮食爐接駁點	-	-	1	1	1	-	-	1	1	1	-	-	-	-	1	1	1	-	-	1	1	1	-	
	Towngas Connection Point 煤氣接駁點	1	1	-	-	-	1	1	-	-	-	1	1	1	1	1	-	-	-	1	1	-	-	-	
	Washing Machine Water Supply 洗衣機來水位	1	1	1	1	1	1	1	1	1	1	1	1	1	1	1	1	1	1	1	1	1	1	1	
	Washing Machine Drain 洗衣機去水位	1	1	1	1	1	1	1	1	1	1	1	1	1	1	1	1	1	1	1	1	1	1	1	
	Fire Service Sprinkler Head 消防花灑頭	3	4	3	3	3	2	3	3	3	3	4	4	3	4	3	3	3	2	3	3	3	3	4	
Miniature Circuit Breakers Board 總電掣箱	1	1	1	-	1	1	-	1	1	1	-	-	1	1	1	-	1	1	-	1	1	1	-		
Bathroom 浴室	Lighting Point 燈位	3	3	3	3	3	3	3	3	3	3	3	3	3	3	3	3	3	3	3	3	3	3		
	Switch with Connection Unit for Exhaust Fan 抽氣扇開關掣連接線位	1	1	1	1	1	1	1	1	1	1	1	1	1	1	1	1	1	1	1	1	1	1		
	Switch with Connection Unit for Thermo Ventilator 浴室寶開關掣連接線位	1	1	1	1	1	1	1	1	1	1	1	1	1	1	1	1	1	1	1	1	1	1		
	32A TPN Weatherproof Switch for Electric Water Heater 防水32A 三相電熱水爐開關掣連接線位	1	1	1	1	1	1	1	1	1	1	1	1	1	1	1	1	1	1	1	1	1	1		
	13A Twin Socket Outlet With USB 13安培雙位電插座連USB	1	1	1	1	1	1	1	1	1	1	1	1	1	1	1	1	1	1	1	1	1	1		

## Notes:

- "1, 2, ....." as shown in the above table denotes the quantity of such provision(s) provided in the residential property.
- The symbol "-" as shown in the above table denotes "Not Provided".
- The symbol "/" as shown in the above table denotes "Not Applicable".
- 4/F, 13/F, 14/F and 24/F are omitted.

## 備註:

- 上表「1, 2, .....
- 上表“-”代表「不提供」。
- 上表“/”代表「不適用」。
- 不設4樓、13樓、14樓及24樓。

Schedule of Electrical &amp; Mechanical Provisions of Residential Units 住宅單位機電裝置數量說明表

Location 位置	Appliances 設備	Tower 5 (5B) 第5座(5B) Floor and Unit 樓層及單位 10/F - 12/F, 15/F - 23/F & 25/F 10樓至12樓、15樓至23樓及25樓												Tower 5 (5B) 第5座(5B) Floor and Unit 樓層及單位 26/F 26樓											
		A	B	C	D	E	F	G	H	J	K	M	N	A	B	C	D	E	F	G	H	J	K	M	N
Bedroom 睡房	Lighting Point 燈位	1	1	/	/	/	/	/	/	/	/	1	1	1	1	/	/	/	/	/	/	/	1	1	
	Lighting Switch 燈掣	1	1	/	/	/	/	/	/	/	/	1	1	1	1	/	/	/	/	/	/	/	1	1	
	13A Single Socket Outlet 13安培單位電插座	1	1	/	/	/	/	/	/	/	/	1	1	1	1	/	/	/	/	/	/	/	1	1	
	TV / FM Outlet 電視 / 電台天線插座	1	1	/	/	/	/	/	/	/	/	1	1	1	1	/	/	/	/	/	/	/	1	1	
	Standby Data Box With Blank Cover 後備數據盒連蓋板	1	1	/	/	/	/	/	/	/	/	1	1	1	1	/	/	/	/	/	/	/	1	1	
	Switch for Air-conditioner Indoor Unit 冷氣機室內機開關掣	1	1	/	/	/	/	/	/	/	/	1	1	1	1	/	/	/	/	/	/	/	1	1	
	13A Twin Socket Outlet With USB 13安培雙位電插座連USB	1	1	/	/	/	/	/	/	/	/	1	1	1	1	/	/	/	/	/	/	/	1	1	
Balcony and Utility Room 露台及工作平台	Lighting Point 燈位	1	1	/	/	/	1	1	/	/	/	1	1	1	1	/	/	/	1	1	/	/	1	1	
	Gas Meter 煤氣錶	1	1	/	/	/	1	1	/	/	/	1	1	1	1	/	/	/	1	1	/	/	1	1	
Balcony 露台	Lighting Point 燈位	/	/	1	1	1	/	/	1	1	1	/	/	/	/	1	1	1	/	/	1	1	1	/	
Air-conditioner Platform 冷氣機平台	Switch for Air-conditioner Outdoor Unit 冷氣機室外機開關掣	1	1	1	1	1	1	1	1	1	1	1	1	1	1	1	1	1	1	1	1	1	1	1	
Roof 天台	Lighting Point 燈位	/	/	/	/	/	/	/	/	/	/	/	/	5	7	5	5	5	7	6	5	/	3	4	
	13A Waterproof Single Socket Outlet 13安培單位防水電插座	/	/	/	/	/	/	/	/	/	/	/	/	1	1	1	1	1	1	1	1	/	1	1	
	Waterproof Lighting Switch 防水燈掣	/	/	/	/	/	/	/	/	/	/	/	/	1	1	1	1	1	1	1	1	/	1	1	

## Notes:

- “1, 2, ……” as shown in the above table denotes the quantity of such provision(s) provided in the residential property.
- The symbol “-” as shown in the above table denotes “Not Provided”.
- The symbol “/” as shown in the above table denotes “Not Applicable”.
- 4/F, 13/F, 14/F and 24/F are omitted.

## 備註：

- 上表「1, 2, ……」表示提供於該住宅物業內的裝置數量。
- 上表“-”代表「不提供」。
- 上表“/”代表「不適用」。
- 不設4樓、13樓、14樓及24樓。



Potable and flushing water is supplied by Water Supplies Department.

Electricity is supplied by CLP Power Hong Kong Limited.

Towngas is supplied by The Hong Kong and China Gas Company Limited.

食水及沖廁水由水務署供應。

電力由中華電力有限公司供應。

煤氣由香港中華煤氣有限公司供應。

The Vendor is liable for the Government Rent payable for the specified residential property up to and including the date of the assignment of that specified residential property.

賣方有法律責任繳付該指明住宅物業之地稅直至該指明住宅物業的轉讓契日期（包括該日）為止。

On the delivery of the vacant possession of the specified residential property to the purchaser, the purchaser is liable to reimburse the Vendor for the deposits for water, electricity and gas.

On that delivery, the purchaser is not liable to pay to the Vendor a debris removal fee.

在向買方交付指明住宅物業在空置情況下的管有權時，買方須負責向賣方補還水、電力及氣體的按金。

在交付時，買方不須向賣方支付清理廢料的費用。

Note:

On that delivery, the purchaser is liable to pay a debris removal fee to the manager (not the Vendor) of the Phase under the Deed of Mutual Covenant and Management Agreement, and where the Vendor has paid the debris removal fee, the purchaser shall reimburse the Vendor for the same.

附註：

在交付時，買方須根據公契及管理協議向期數的管理人（而非賣方）支付清理廢料的費用，而如賣方已支付清理廢料的費用，買方須向賣方補還清理廢料的費用。

As provided in the agreement for sale and purchase, the Vendor shall, at its own cost and as soon as reasonably practicable after receipt of a written notice served by the purchaser within 6 months after the date of completion of the sale and purchase of the specified residential property, remedy any defects in that residential property, or the fittings, finishes or appliances incorporated into that residential property as set out in the agreement for sale and purchase concerned, caused otherwise than by the act or neglect of the purchaser.

按買賣合約的規定，凡指明住宅物業或於買賣合約列出裝設於該住宅物業內的裝置、裝修物料或設備有欠妥之處，而該欠妥之處並非由買方行為或疏忽造成，則賣方在接獲買方在該住宅物業之買賣成交日期後的6個月內送達的書面通知後，須於合理地切實可行的範圍內盡快自費作出補救。

The Land Grant requires the owners of the residential properties in the Phase to maintain slopes at their own cost.

#### A. Terms of the Requirement

Special Condition No.(34)(a) of the Land Grant stipulates that:

“Where there is or has been any cutting away, removal or setting back of any land, or any building-up or filling-in or any slope treatment works of any kind whatsoever, whether with or without the prior written consent of the Director, either within the lot or on any Government land, which is or was done for the purpose of or in connection with the formation, levelling or development of the lot or any part thereof or any other works required to be done by the Purchaser under these Conditions, or for any other purpose, the Purchaser shall at his own expense carry out and construct such slope treatment works, retaining walls or other support, protection, drainage or ancillary or other works as shall or may then or at any time thereafter be necessary to protect and support such land within the lot and also any adjacent or adjoining Government or leased land and to obviate and prevent any falling away, landslip or subsidence occurring thereafter. The Purchaser shall at all times during the term hereby agreed to be granted maintain at his own expense the said land, slope treatment works, retaining walls or other support, protection, drainage or ancillary or other works in good and substantial repair and condition to the satisfaction of the Director.”

Special Condition No.(37) of the Land Grant stipulates that:

(e) The Purchaser shall at his own expense register at the Land Registry against the lot a plan approved by the Director indicating the locations, nature and scope of the Inside Works (as defined under Special Condition No.(37)(c) of the Land Grant) and the Outside Works (as defined under Special Condition No.(37)(c) of the Land Grant) and the location and extent of the areas of the lot and the Government land on which the Purchaser may require or be required to carry out the maintenance works, including the areas of the lot and the Government land where the Purchaser may require or be required by the Director to carry out clearance of landslide debris or boulders under sub-clause (f) of this Special Condition (which plan is hereinafter referred to as “the Natural Terrain Hazard Mitigation and Stabilization Works Plan”). Such areas or floor spaces on or within which the Inside Works are carried out or to be carried out shall be designated as and form part of the Common Areas.

(f) (i) The Purchaser shall at all times during the term hereby agreed to be granted, maintain at his own expense the Inside Works and the Outside Works in good and substantial repair and condition in all respects to the satisfaction of the Director to ensure that the Inside Works and the Outside Works shall continue to perform their designed functions. The maintenance works shall include but not be limited to clearance of landslide debris or boulders fallen onto the Inside Works or the Outside Works or onto the areas of the lot or the Government land shown on the Natural Terrain Hazard Mitigation and Stabilisation Works Plan.”

#### B. Each of the owners is obliged to contribute towards the costs of the maintenance works.

#### C. A plan showing the slope and the retaining wall or related structures constructed, or to be constructed, within or outside the land on which the Phase is situated.

Please refer to the plan at page 236 of this Sales Brochure.

#### D. Under the Deed of Mutual Covenant, the manager of the Phase has the owners’ authority to carry out the maintenance works.

Clause (3:02:01)(aq) of the latest draft Deed of Mutual Covenant stipulates that:

“Save and except as otherwise expressly provided in this Deed, the Manager shall be responsible for and shall have full authority to do all such acts and things as may be necessary or requisite for and in connection with the proper and efficient management of the Development, including in particular but without in any way limiting the generality of the foregoing :-

(aq) to engage suitable qualified personnel to inspect, keep and maintain in good substantial repair and condition and carry out any necessary works in respect of the Slope and Retaining Structures in compliance with the Government Grant and in particular in accordance with the Geoguide 5 - Guide to Slope Maintenance issued by the Geotechnical Engineering Office (as amended or substituted from time to time) and the Maintenance Manual and all guidelines issued from time to time by the appropriate Government departments regarding the maintenance of the Slope and Retaining Structures. For this purpose, the Manager shall have the right to demand from the Owners, and the Owners shall be liable to pay, such contributions to all the costs lawfully incurred or to be incurred in carrying out such maintenance and repair and any other works in respect of the Slope and Retaining Structures by way of a lump sum or instalments or otherwise as the Manager shall decide PROVIDED THAT the Manager shall not be made personally liable for carrying out any such requirements of the Government Grant which shall remain the responsibility of the Owners if, having used all reasonable endeavours, the Manager has not been able to collect the costs of the required works from all Owners. For the purpose of this Clause, the Manager shall include the Owners’ Corporation;”

批地文件規定，期數中的住宅物業的擁有人須自費維修斜坡。

#### A. 該規定的條款

批地文件特別條款第(34)(a)條規定：

「如果任何土地需要或已經被削土、移除或後移或堆積或堆填或進行任何類型的斜坡處理工程，不論有否經署長預先書面同意，亦不論是在該地段內或任何政府土地上，其進行旨在或有關構建、平整或發展該地段或其中任何部份或購買人按此等條款要求進行的任何其他工程或作任何其他用途，購買人須自費進行與建造該等斜坡處理工程、護土牆或其他支撐物、保護物、排水或輔助工程或當時或今後任何時候為保護與支撐該地段和任何毗鄰或毗連政府土地或出租土地內的土地及避免與防止今後發生任何塌方、山泥傾瀉或地陷之必要工程。購買人須在同意批租年期期間所有時候自費保養上述土地、斜坡處理工程、護土牆或其他支撐物、保護物、排水或輔助工程或其他工程，使其處於修葺良好堅固的狀態，使署長滿意。」

批地文件特別條款第(37)條規定：

「(e) 購買人須自費在土地註冊處就該地段註冊一份由署長批准的圖則，其顯示「地段內工程」(定義見批地文件特別條款(37)(c)條)及「地段外工程」(定義見批地文件特別條款(37)(c)條)的位置、性質及範圍，及購買人可能須要或被要求對其進行維修工作的該地段及政府土地的範圍的位置及幅度(包括購買人可能須要或被署長要求按本特別條款第(f)款對其進行清理山泥傾瀉殘骸或落石的該地段及政府土地的範圍)，而該圖則下文將稱內「天然山坡危害緩解和鞏固工程圖則」。該等進行或將進行「地段內工程」的範圍或樓面須被指定為及構成「公用地方」一部份。

(f) (i) 購買人在同意批租年期內一切時間須自費保養「地段內工程」及「地段外工程」，使其維持在良好和修繕妥當的狀況並確保「地段內工程」及「地段外工程」能繼續發揮其設定的作用，並在一切方面令署長滿意。保養工作包括但不限於清理下墜於「地段內工程」或「地段外工程」或在「天然山坡危害緩解和鞏固工程圖則」上所示的該土地或政府土地的山泥傾瀉殘骸和落石。」

#### B. 每名擁有人均須分擔維修工程的費用。

#### C. 顯示該斜坡及已經或將會在期數所位於的土地之內或之外建造的任何護土牆或有關構築物的圖則。

請參閱本售樓說明書第236頁之圖則。

#### D. 根據公契，期數的管理人獲擁有人授權進行維修工程。

公契最新擬稿第(3:02:01)(aq)條規定：

「除本公契另有明文規定外，管理人須負責並具有充分授權作出與妥善及有效管理發展項目所必要或需要的一切行為及事情，在任何方面不限制上述一般適用範圍的前提下，特別是包括：

(aq) 按批地文件，特別是按土力工程處印發的「岩土指南第五冊－斜坡維修指南」(並以不時的修訂或代替條文為準)及依據保養手冊和有關政府部門不時對保養斜坡及護土構築物發出的一切指引，聘請合適及合格的人士視察、檢驗、妥善保持和保養斜坡及護土構築物並對其進行任何必要的工程。為了這個目的，管理人有權要求業主(及業主有責任)支付進行上述保養與維修斜坡構築物及任何其他有關工程所合法支出或將支出的分擔款項，該分擔款項須以整筆款項支付或分期付款或管理人決定的其他形式支付，惟如果管理人儘其一切合理努力，仍未能向全體業主收集所要求的工程費用，則管理人毋須對履行批地文件條款內有關斜坡及護土構築物的任何該等要求承擔個人責任，該等責任仍須由業主承擔。就本條款而言，管理人包括業主立案法團；」

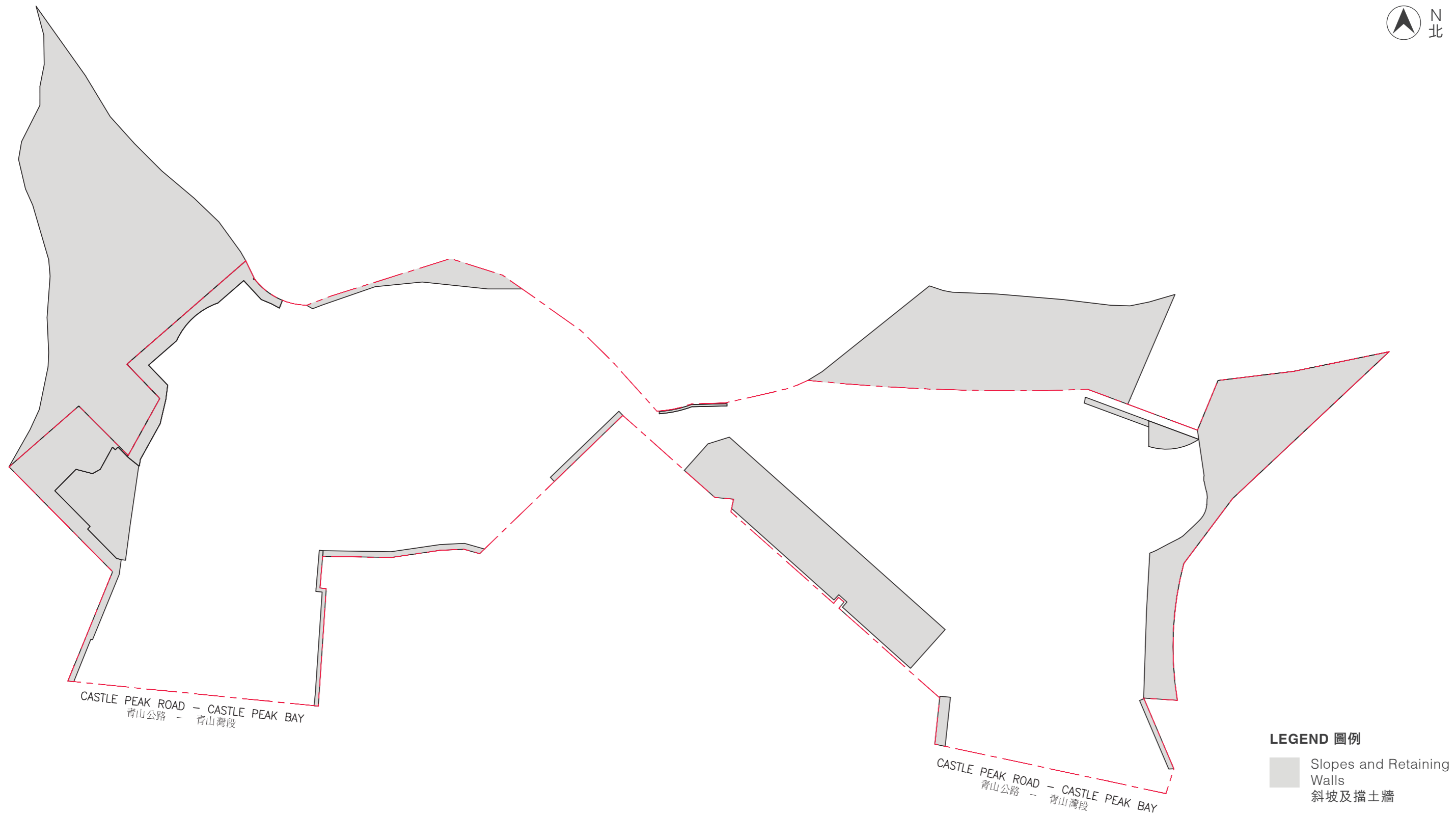

**LEGEND 圖例**

- Slopes and Retaining Walls  
斜坡及擋土牆
- Site Boundary of the Development  
發展項目的地盤界限

Scale 0 50M/米  
比例

No application to the Government for a modification of the Land Grant in respect of the Phase is underway.

現時並沒有向政府就本期數提出申請修訂批地文件。



**1. Noise Mitigation Measures**

The following measures to mitigate road traffic noise impact from Tuen Mun Road and Castle Peak Road, etc. will be provided in the Phase:

- 1) Solid Balustrades
- 2) Acoustic Sliding Doors
- 3) Acoustic Windows 1 (Acoustic Windows with Micro-Perforated Plate Acoustic Panel, Baffle Type)
- 4) Acoustic Windows 2 (Acoustic Windows without Micro-Perforated Plate Acoustic Panel, Baffle Type)
- 5) Maintenance Windows (Fixed Glazings with maintenance windows, not for ventilation uses)
- 6) Self-Closing Swing Doors (Fixed Glazings with maintenance platform, not for ventilation uses)
- 7) Sound Absorption Materials

Please refer to “Floor Plans of Residential Properties in the Phase” section of this Sales Brochure for details on the location.

For details of such noise mitigation measures and related units in the Phase, prospective purchases should refer to the Noise Impact Assessment Report dated March 2024 (Reference Number: 1782EA).

Copy of the Noise Impact Assessment Report will be available for free inspection upon request by prospective purchasers at the sales office during its opening hours (photocopies will be available on payment of photocopying charges).

Please also refer to “Floor Plans of Residential Properties in the Phase” section of this Sales Brochure for details on the location of Acoustic Sliding Doors marked “A.S.D”, Acoustic Windows 1 (Acoustic Windows with Micro-Perforated Plate Acoustic Panel, Baffle Type) marked “A.W.1”, Acoustic Windows 2 (Acoustic Windows without Micro-Perforated Plate Acoustic Panel, Baffle Type) marked “A.W.2”, Maintenance Windows (Fixed Glazings with maintenance windows, not for ventilation uses) marked “M.W.” and Self-Closing swing Doors (Fixed Glazings with maintenance platform, not for ventilation uses) marked “S.C.D”. Prospective purchasers should note the impact of the existence of noise mitigation measures on the views of related units and that the related units may be affected by noise if the Acoustic Sliding Doors, the Acoustic Windows 1 (Acoustic Windows, Baffle Type), the Acoustic Windows 2 (Acoustic Windows, Baffle Type), the Maintenance Windows (Fixed Glazings with maintenance windows, not for ventilation uses) and the Self-Closing swing Doors (Fixed Glazings with maintenance platform, not for ventilation uses) are opened.

**2. Construction of Subsequent Phases**

There may be special traffic arrangement including but not limited to alteration of vehicular access route during the construction of subsequent phases. Construction vehicles may also enter the podium level and the car park for construction of subsequent phases. Such construction works and arrangement may materially affect the enjoyment of the residential properties in the Phase in terms of views, noise, dust and/or other aspects of the surrounding environment.

**3. Placement of outdoor air-conditioning units**

Some outdoor air-conditioning units (either serving its own residential unit or other residential units) are placed on the air-conditioner platforms, high level of balconies, utility platforms, private gardens, private flat roofs, private roofs or inaccessible common flat roof. The placement of the outdoor air-conditioning units may affect the enjoyment of the residential units of the Phase in terms of heat and noise or other aspects. For the locations of the outdoor air-conditioning units, please refer to “Floor Plans of Residential Properties in the Phase”.

**4. Architectural features**

Some architectural features are installed outside the external walls of some residential units of the Phase. The illumination (if any) of the architectural features may affect the enjoyment of some residential units.

**5. Pipes**

Some common pipes and/or exposed pipes are located on the external walls at or adjacent to the flat roofs and/or balconies of some residential units of the Phase. It is possible that the views of some residential units may be affected by these pipes. For the locations of the common pipes and the exposed pipes, please refer to the latest approved building plans of the Phase.

**6. Trees**

There are many trees outside the lot surrounding the Development. Some of the trees may be of similar height to the level of the lower level residential units of the Phase. In addition, some of the trees may be located close to some of the residential units of the Phase. Prospective purchasers should conduct an on-site visit for a better understanding of the Development site and its surrounding environment.

**7. Operation of building maintenance system**

Under the Deed of Mutual Covenant, the Manager shall have the right from time to time for the purposes of inspecting, rebuilding, repairing, altering, renewing, maintaining, cleaning, painting or decorating the Common Areas and Facilities or carrying out necessary repairs to the Development or abating any hazard or nuisance which does or may affect the Common Areas and Facilities or any part thereof or other Owners to install and remove anchors and other provisions at the building perimeter of the private garden, private flat roof or private roof forming part of a Residential Unit for operation of the building maintenance system including but not limited to gondola or an equipment of the like which shall be entitled to pass through and/or rest on private garden, private flat roof or private roof forming part of a Residential Unit.

**1. 噪音緩解措施**

發展項目將提供以下措施以緩解屯門公路、青山公路 - 青山灣段等帶來的道路交通噪音影響：

- 1) 實心欄杆
- 2) 減音趟門
- 3) 減音窗戶 1 (減音窗戶連微米穿透孔吸音薄片，擋音式)
- 4) 減音窗戶 2 (減音窗戶無微米穿透孔吸音薄片，擋音式)
- 5) 維修窗戶 (固定式窗戶連維修窗戶，不作通風用途)
- 6) 自動關閉掩門 (固定式窗戶連維修平台，不作通風用途)
- 7) 吸音物料

有關位置，請參閱本售樓說明書的「期數的住宅物業的樓面平面圖」一節。

有關噪音消減措施詳情及期數內的相關單位，準買家應參考2024年3月的噪音影響評估報告(參考編號1782EA)。

準買家可於售樓處開放時間內要求免費查閱噪音影響評估報告(並可於支付影印費後取得影印本)。

有關減音趟門(以「A.S.D.」標示)、減音窗戶 1 (減音窗戶連微米穿透孔吸音薄片，擋音式)(以「A.W.1」標示)、減音窗戶 2 (減音窗戶無微米穿透孔吸音薄片，擋音式)(以「A.W.2」標示)、維修窗戶 (固定式窗戶連維修窗戶，不作通風用途)(以「M.W.」標示)及自動關閉掩門 (固定式窗戶連維修平台，不作通風用途)(以「S.C.D.」標示)的位置，準買家亦應參考本售樓說明書「期數的住宅物業的樓面平面圖」一節。準買家應注意噪音緩解措施對相關單位景觀的影響，以及如減音趟門、減音窗戶 1 (減音窗戶連微米穿透孔吸音薄片，擋音式)、減音窗戶 2 (減音窗戶無微米穿透孔吸音薄片，擋音式)、維修窗戶 (固定式窗戶連維修窗戶，不作通風用途)、或自動關閉掩門 (固定式窗戶連維修平台，不作通風用途) 被開啟時相關單位將可能受噪音影響。

**2. 後續期數的施工**

後續期數的施工期間可能會制定特別交通安排，包括但不限於更改行車通道。建築車輛亦可進入平台層及車場以進行後續期數的施工，施工期間可能對期數內住宅物業之享用，諸如景觀、噪音、沙塵及 / 或周邊環境方面，造成重大影響。

**3. 放置室外冷氣機**

部分室外冷氣機(不論是為該住宅單位而設或是為其他住宅單位而設)放置在室外的冷氣機平台、露台的上方、工作平台、私人花園、私人平台、私人天台或維修平台。室外冷氣機的放置可能對期數的住宅單位的享用，諸如熱氣及噪音或其他方面造成影響。有關室外冷氣機的位置，請參閱「期數的住宅物業的樓面平面圖」。

**4. 建築裝飾**

期數部分住宅單位外的外牆裝有建築裝飾，建築裝飾的燈光(如有的話)可能對部分住宅單位的享用造成影響。

**5. 喉管**

期數部分住宅單位的外牆或毗鄰平台及 / 或露台的外牆裝有公用喉管及 / 或外露喉管。部分住宅單位的景觀可能因此受到影響。有關公用喉管及外露喉管的位置，請參閱期數最新批准建築圖則。

**6. 樹木**

該地段外有很多樹於發展項目的外圍。有些樹的高度可能與期數低層住宅單位的高度相若。另外，有些樹與期數部份住宅單位的距離可能很近。準買家應到有關發展地盤作實地考察，以對該發展地盤及其周邊地區環境有較佳了解。

**7. 建築物維修系統的操作**

根據公契，管理人有權不時為檢查、重建、維修、改動、翻新、保養、清潔、油漆或裝飾公用地方及設施或進行發展項目必要的維修或減少任何對或可能對公用地方及設施或任何部分或其他業主造成影響的危害或滋擾的目的，於構成住宅單位一部分的私人花園、私人平台或私人天台的建築周邊安裝及拆除錨及其他裝置以便建築物維修系統的操作，包括但不限於吊船或其他類似裝置。吊船或其他類似裝置可以經過及 / 或停泊於構成住宅單位一部分的私人花園、私人平台或私人天台。

The address of the website designated by the Vendor of the Phase for the purposes of Part 2 of the Residential Properties (First-hand Sales) Ordinance: [www.goldcoastbay.hk](http://www.goldcoastbay.hk)

賣方為施行《一手住宅物業銷售條例》第2部而就期數指定的互聯網網站的網址：[www.goldcoastbay.hk](http://www.goldcoastbay.hk)

**Breakdown of GFA Concessions Obtained for All Features**

Latest information on breakdown of GFA concessions as shown on the general building plans submitted to and approved by the Building Authority (BA) prior to the printing of the sales brochure is tabulated below. Information marked (#) may be based on information provided by the Authorized Person if the sales brochure is printed prior to submission of the final amendment plans to the BA. The breakdown of GFA concessions may be subject to further changes until final amendment plans are submitted to and approved by the BA prior to the issuance of the occupation permit for the Phase.

**獲寬免總樓面面積的設施分項**

於印製售樓說明書前呈交予並已獲建築事務監督批准的一般建築圖則上有關總樓面面積寬免的分項的最新資料，請見下表。如印製售樓說明書時尚未呈交最終修訂圖則予建築事務監督，則有(＃)號的資料可以由認可人士提供的資料作為基礎。直至最終修訂圖則於發出期數佔用許可證前呈交予並獲建築事務監督批准前，以下分項資料仍可能有所修改。

		Area (m <sup>2</sup> ) 面積 (平方米)
Disregarded GFA under Building (Planning) Regulations 23(3)(b) 根據《建築物(規劃)條例》第23(3)(b)條不計算的總樓面面積		
1 (#)	Carpark and loading/ unloading area excluding public transport terminus 停車場及上落客貨地方(公共交通總站除外)	7110.809
2	Plant rooms and similar services 機房及相類設施	
2.1	Mandatory feature or essential plant room, area of which is limited by respective Practice Notes for Authorized Persons, Registered Structural Engineers and Registered Geotechnical Engineers (PNAP) or regulation such as lift machine room, telecommunications and broadcasting (TBE) room, refuse storage and material recovery chamber, etc. 所佔面積受相關《認可人士、註冊結構工程師及註冊岩土工程師作業備考》或規例限制的強制性設施或必要機房，例如升降機機房、電訊及廣播設備室、垃圾及物料回收房等	897.21
2.2 (#)	Mandatory feature or essential plant room, area of which is NOT limited by any PNAP or regulation such as room occupied solely by fire services installations (FSI) and equipment, meter room, transformer room, potable and flushing water tank, etc. 所佔面積不受任何《認可人士、註冊結構工程師及註冊岩土工程師作業備考》或規例限制的強制性設施或必要機房，例如僅供消防裝置及設備佔用的房間、電錶房、電力變壓房、食水及鹹水缸等	5331.732
2.3	Non-mandatory or non-essential plant room such as air-conditioning (A/C) plant room, air handling unit (AHU) room, etc. 非強制性或非必要機房，例如空調機房、風櫃房等	1.187

		Area (m <sup>2</sup> ) 面積 (平方米)
Green Features under Joint Practice Notes 1 and 2 根據聯合作業備考第1及第2號提供的環保設施		
3	Balcony 露台	1413.797
4	Wider common corridor and lift lobby 加闊的公用走廊及升降機大堂	186.245
5	Communal sky garden 公用空中花園	Not applicable 不適用
6	Acoustic fin 隔聲鳍	Not applicable 不適用
7	Wing wall, wind catcher and funnel 翼牆、捕風器及風斗	Not applicable 不適用
8	Non-structural prefabricated external wall 非結構預製外牆	799.128
9	Utility platform 工作平台	913.523
10	Noise barrier 隔音屏障	Not applicable 不適用

## Note:

The above table is based on the requirements as stipulated in the Practice Note for Authorized Persons, Registered Structural Engineers and Registered Geotechnical Engineers ADM-2 issued by the Buildings Department. The Buildings Department may revise such requirements from time to time as appropriate.

## 備註：

上述表格是根據屋宇署所發出的《認可人士、註冊結構工程師及註冊岩土工程師作業備考》ADM-2規定的要求而制訂的。屋宇署會按實際需要不時更改有關要求。

		Area (m <sup>2</sup> ) 面積 (平方米)
Amenity features 適意設施		
11	Caretaker's quarters, counter, office, store, guard room and lavatory for watchman and management staff and owners' corporation office 供保安人員和管理處員工使用的櫃枱、辦公室、儲物室、警衛室和廁所、業主立案法團辦公室	32.185
12	Residential recreational facilities including void, plant room, swimming pool filtration plant room, covered walkway, etc. serving solely the recreational facilities 住宅康樂設施，包括僅供康樂設施使用的中空、機房、游泳池的濾水器機房、有蓋人行道等	1590.332
13	Covered landscaped and play area 有上蓋的園景區及遊樂場	2527.844
14	Horizontal screens/ covered walkways, trellis 橫向屏障 / 有蓋人行道、花棚	32.262
15	Larger lift shaft 擴大升降機井道	477.436
16	Chimney shaft 煙囪管道	Not applicable 不適用
17	Other non-mandatory or non-essential plant room, such as boiler room, satellite master antenna television (SMATV) room 其他非強制性或非必要機房，例如鍋爐房、衛星電視共用天線房	1.348
18 (#)	Pipe duct, air duct for mandatory feature or essential plant room 強制性設施或必要機房所需的管槽、氣槽	955.434
19	Pipe duct, air duct for non-mandatory or non-essential plant room 非強制性設施或非必要機房所需的管槽、氣槽	141.433
20	Plant room, pipe duct, air duct for environmentally friendly system and feature 環保系統及設施所需的機房、管槽及氣槽	99.014
21	Void in duplex domestic flat and house 複式住宅單位及洋房的中空	Not applicable 不適用
22	Sunshade and reflector 遮陽篷及反光罩	Not applicable 不適用
23 (#)	Minor projection such as A/C box, A/C platform, window cill and projecting window 小型伸出物，例如空調機箱、空調機平台、窗檻及伸出的窗台	Not applicable 不適用

		Area (m <sup>2</sup> ) 面積 (平方米)
24	Other projection such as A/C box and platform not covered in paragraph 3(b) and (c) of PNAP APP-19 《作業備考》APP.19 第 3 (b) 及 (c) 段沒有涵蓋的其他伸出物，如空調機箱及空調機平台	Not applicable 不適用
Other Exempted Items 其他獲豁免的項目		
25	Refuge floor including refuge floor cum sky garden 庇護層，包括庇護層兼空中花園	Not applicable 不適用
26	Covered area under large projecting/ overhanging feature 大型伸出 / 外懸設施下的有蓋地方	Not applicable 不適用
27	Public transport terminus 公共交通總站	Not applicable 不適用
28	Party structure and common staircase 共用構築物及樓梯	Not applicable 不適用
29 (#)	Horizontal area of staircase, lift shaft and vertical duct solely serving floor accepted as not being accountable for GFA 僅供獲接納不計入總樓面面積的樓層使用的樓梯、升降機槽及垂直管道的水平面積	1284.454
30	Public passage 公眾通道	Not applicable 不適用
31	Covered set back area 因建築物後移導致的覆蓋面積	Not applicable 不適用
Bouns GFA 額外總樓面面積		
32	Bonus GFA 額外總樓面面積	Not applicable 不適用
Additional Green Features under Joint Practice Note (No. 8) 根據聯合作業備考 (第 8 號) 提供的額外環保設施		
33	Buildings adopting Modular Integrated Construction 採用「組裝合成」建築法的樓宇	Not applicable 不適用

## Note:

The above table is based on the requirements as stipulated in the Practice Note for Authorized Persons, Registered Structural Engineers and Registered Geotechnical Engineers ADM-2 issued by the Buildings Department. The Buildings Department may revise such requirements from time to time as appropriate.

## 備註：

上述表格是根據屋宇署所發出的《認可人士、註冊結構工程師及註冊岩土工程師作業備考》ADM-2規定的要求而制訂的。屋宇署會按實際需要不時更改有關要求。

## Environmental Assessment of the Building

## 建築物的環境評估

**Green Building Certification**

Assessment result under the **BEAM Plus** certification conferred / issued by Hong Kong Green Building Council Limited (HKGBC) for the building prior to the printing of the sales brochure or

**Provisional  
BRONZE**



PROVISIONAL  
**BRONZE**  
NB V1.2 2024  
HKGBC  
BEAM Plus

Application no.: REG0024/24

**綠色建築認證**

在印刷此售樓說明書或其附頁前，本物業根據香港綠色建築議會有限公司頒授 / 發出的綠建環評認證評級。

**暫定評級  
銅級**



暫定  
**銅級**  
NB V1.2 2024  
HKGBC  
綠建環評

申請編號: REG0024/24

**Estimated Energy Performance or Consumption for the Common Parts of the Development**

Latest information on the estimated energy performance or consumption for the common parts of the development as submitted to the Building Authority prior to the printing of the sales brochures:

**發展項目的公用部分的預計能量表現或消耗**

於印製售樓說明書前呈交予建築事務監督發展項目的公用部分的預計能量表現或消耗的最近期資料：

Part I 第 I 部分	
Provision of Central Air Conditioning 提供中央空調	YES 是
Provision of Energy Efficient Features 提供具能源效益的設施	YES 是
Energy Efficient Features proposed: 擬安裝的具能源效益的設施：	Lower lighting power density in common area 公用地方低能耗照明

Part II: The predicted annual energy use of the proposed building/ part of building (Note 1) 第 II 部分：擬興建樓宇 / 部分樓宇預計每年能源消耗量 ((備註 1))：					
Location 位置	Internal Floor Area Served (m <sup>2</sup> ) 使用有關裝置的內部樓面面積 (平方米)	Annual Energy Use of Baseline Building (Note 2) 基線樓宇 (備註 2) 每年能源消耗量		Annual Energy Use of Proposed Building 擬興建樓宇每年能源消耗量	
		Electricity kWh/m <sup>2</sup> /annum 電力 千瓦小時 / 平方米 / 年	Town Gas / LPG unit/m <sup>2</sup> /annum 煤氣 / 石油氣 用量單位 / 平方米 / 年	Electricity kWh/m <sup>2</sup> /annum 電力 千瓦小時 / 平方米 / 年	Town Gas / LPG unit/m <sup>2</sup> /annum 煤氣 / 石油氣 用量單位 / 平方米 / 年
Area served by central building services installation (Note 3) 有使用中央屋宇裝備裝置 (備註 3) 的部份	Domestic area served by central building services installation: 使用中央屋宇裝備裝置的住用部分： 9856.021	1237	Not applicable 不適用	1019	Not applicable 不適用
	Non-Domestic area (Podium) served by central building services installation: 使用中央屋宇裝備裝置的非住用部份 (平台)：1587.107	950	Not applicable 不適用	724	Not applicable 不適用

Part III: The following installation(s) is/are designed in accordance with the relevant Codes of Practices published by the Electrical & Mechanical Services Department (EMSD) 第 III 部分：以下裝置乃按機電工程署公布的相關實務守則設計：			
Type of Installations 裝置類型	YES 是	NO 否	Not applicable 不適用
Lighting Installations 照明裝置	✓	-	-
Air Conditioning Installations 空調裝置	✓	-	-
Electrical Installations 電力裝置	✓	-	-
Lift & Escalator Installations 升降機及自動梯的裝置	✓	-	-
Performance-based Approach 以總能源為本的方法	-	-	✓

## Notes:

- In general, the lower the estimated “Annual Energy Use” of the building, the more efficient of the building in terms of energy use. For example, if the estimated “annual energy use of proposed building” is less than the estimated “annual energy use of baseline building”, it means the predicted use of energy is more efficient in the proposed building than in the baseline building. The larger the reduction, the greater the efficiency.

The predicted annual energy use, in terms of electricity consumption (kWh/m<sup>2</sup>/annum) and town gas/LPG consumption (unit/m<sup>2</sup>/annum), of the development by the internal floor area served, where:

- “total annual energy use” has the same meaning of “annual energy use” under Section 4 and Appendix 8 of the BEAM Plus for New Buildings (current version); and
  - “internal floor area”, in relation a building, a space or a unit means the floor area of all enclosed space measured to the internal faces of enclosing external and/or party walls.
- “Baseline Building” has the same meaning as “Baseline Building Model (zero-credit benchmark)” under Section 4 and Appendix 8 of the BEAM Plus for New Building (current version).
  - “Central Building Services Installation” has the same meaning as that in the Code of Practice for Energy Efficiency of Building Services Installations in Buildings.

## 備註：

- 一般而言，一棟樓宇的預計「每年能源消耗量」愈低，其節約能源的效益愈高。如一棟樓宇預計的「每年能源消耗量」低於該樓宇的「基線樓宇每年能源消耗量」，則代表預計該樓宇的能源應用較其基線樓宇有效，削減幅度愈大則代表有關樓宇能源節約的效益愈高。

預計每年能源消耗量（以耗電量（千瓦小時/平方米/年）及煤氣/石油氣消耗量（用量單位/平方米/年）計算），指將發展項目的每年能源消耗總量除以使用有關裝置的內部樓面面積所得出的商，其中：

- 「每年能源消耗量」與新建樓宇 BEAM Plus 標準（現行版本）第 4 節及附錄 8 中的「年能源消耗」具有相同涵義；及
  - 樓宇、空間或單位的「內部樓面面積」，指外牆及/或共用牆的內壁之內表面起量度出來的樓面面積。
- 「基準樓宇」與新建樓宇 BEAM Plus 標準（現行版本）第 4 節及附錄 8 中的「基準建築物模式（零分標準）」具有相同涵義。
  - 「中央屋宇裝備裝置」與樓宇的屋宇裝備裝置能源效益實務守則中的涵義相同。



1. The purchaser is required to agree with Ocean Regal Limited (“the Vendor”) in the agreement for sale and purchase (“ASP”) to the effect that other than entering into a mortgage or charge, the purchaser will not nominate any person to take up the Assignment of the Residential Unit or the Parking Space specified in the ASP, sub-sell that Residential Unit or Parking Space or transfer the benefit of the ASP of that Residential Unit or Parking Space in any manner whatsoever or enter into any agreement so to do before completion of the sale and purchase and execution of the Assignment.
2. If the Vendor, at the request of the purchaser under an ASP, agrees (at its own discretion) to cancel the ASP or the obligations of the purchaser under the ASP, the Vendor is entitled to retain the sum of five percent (5%) of the total purchase price of the Residential Unit and the Parking Space specified in the ASP and the purchaser will in addition pay or reimburse (as the case may be) to the Vendor all legal costs, charges and disbursements (including any stamp duty) in connection with the cancellation of the ASP.
3. The Vendor will pay or has paid (as the case may be) all outstanding Government rent in respect of the land on which the Development is in the course of being erected, from the date of the Land Grant up to and including the date of the respective Assignments to the purchasers.
4. The purchaser who has signed an ASP has the right of access to and will, upon his request, be provided with a hard copy of an updated record of information as to the total construction costs and the total professional fees to complete the Phase as well as the total construction costs and the total professional fees expended and paid as at the end of the calendar month preceding the month at which the request is made subject to payment of a nominal fee of not more than HK\$100 per request.
5. Information relating to (i) the Green Areas and the Structures as referred to in Special Conditions Nos.(3) to (6) of the Land Grant, (ii) the route within the lot (as defined in the Land Grant) to and from the Existing Graves as referred to in Special Condition No.(41)(a) of the Land Grant, and (iii) the Pedestrian Walkway as referred to in Special Condition No.(41)(b) of the Land Grant :-

Please refer to the sections “Summary of Land Grant” and “Information on Public Facilities and Public Open Spaces” of this sales brochure.

1. 買方須於正式買賣合約（「買賣合約」）下與海琪有限公司（「賣方」）約定，除訂立按揭或押記外，在買賣完成及簽署轉讓契前，買方不得提名任何人士接受買賣合約指明之住宅單位或停車位之轉讓、轉售該住宅單位或停車位或以任何形式轉移該住宅單位或停車位之買賣合約之權益，或訂立任何有關上述提名、轉售或轉移權益之協議。
2. 若賣方應買賣合約下買方要求同意（同意與否賣方有酌情權決定）取消買賣合約或買賣合約下買方之責任，賣方有權保留等同買賣合約指明之住宅單位及停車位總售價 5% 之金額，另買方須向賣方繳付或補還（視屬何情況而定）所有與取消買賣合約有關之法律費用、收費及開銷（包括任何印花稅）。
3. 賣方將會或已經（視屬何情況而定）支付所有有關發展項目正在其上興建之土地於批地文件日期起計至相關買方轉讓契日期（包括該日）期間之未付地稅。
4. 已簽署買賣合約之買方，如已支付不多於港幣 \$100 之象徵式費用（按每次要求計），有權獲取（而當其要求時將獲提供）以下資料之最新紀錄印本：完成期數的總建築費用及總專業費用及截至作出該要求當月前之公曆月份完結時已支出和繳付之總建築費用及總專業費用。
5. 有關 (i) 批地文件特別條款第 (3) 條至第 (6) 條提及的「綠色範圍」及「該等構築物」、(ii) 批地文件特別條款第 (41)(a) 條提及的在「該地段」（定義見批地文件）內進出「現有墳墓」的路線、及 (iii) 批地文件特別條款第 (41)(b) 條提及的「行人路」的資料：

請參閱本售樓說明書中「批地文件的摘要」一節及「公共設施及公眾休憩用地的資料」一節。

Date of printing of Sales Brochure: 13 June 2024

售樓說明書印製日期：2024年6月13日

There may be future changes to the Phase and the surrounding areas.

期數及其周邊地區日後可能出現改變。

Examination / Revision Date 檢視 / 修改日期	Page Number 頁數	Revision Made 所作修改
3 July 2024 2024年7月3日	138, 139, 140, 141, 163, 200, 201, 202, 203, 204, 205, 206, 207, 208, 209, 212, 213, 216, 217, 220, 221, 224, 225, 227, 228	Fittings, Finishes and Appliances are updated. 裝置、裝修物料及設備已更新。
2 October 2024 2024年10月2日	16	Location plan of the development is updated. 更新發展項目的所在位置圖。
	17	Aerial photograph of the Phase is updated. 更新期數的鳥瞰照片。
	18, 19, 20	Pages 18, 19 and 20 are deleted and replaced with blank pages. 刪除第18、19及20頁並換上空頁。
	21	Outline zoning plan relating to the development is updated. 更新關於發展項目的分區計劃大綱圖。
	22	Layout plan of the development is updated. 更新發展項目的布局圖。
	26, 28, 30, 32, 34, 36, 38, 46, 48, 50, 56, 58	Floor plans of residential properties in the phase is updated. 更新期數的住宅物業的樓面平面圖。
	61	Area of residential properties in the phase is updated. 更新期數中的住宅物業的面積。
	119	Information on public facilities and public open spaces is updated. 更新公共設施及公眾休憩用地的資料。
	125, 126, 127, 128, 129, 130, 131, 132, 133	Elevation plan is updated. 更新立面圖。
	161, 193, 208, 209, 210, 212, 213, 214, 216, 217, 219, 220, 221, 223, 225, 228	Fittings, finishes and appliances is updated. 更新裝置、裝修物料及設備。
	241, 242, 243	Information in application for concession on gross floor area of building is updated. 更新申請建築物總樓面面積寬免的資料。
4 December 2024 2024年12月4日	26, 28, 30, 32, 34, 36, 38, 40, 42, 44, 46, 48, 50, 52, 54, 56, 58	Floor plans of residential properties in the phase is updated. 更新期數的住宅物業的樓面平面圖。
	119a, 119b	Information on public facilities and public open spaces is updated. 更新公共設施及公眾休憩用地的資料。
	247	The statement that "There may be future changes to the Phase and the surrounding areas." has been added. 新增「期數及其周邊地區日後可能出現改變。」之述明。



